

INSTRUMENT USER'S HANDBOOK

Model 4950

Multifunction Transfer Standard

Instrument User's Handbook

for

The Model 4950 Multifunction Transfer Standard

(for System and Software Information, refer to the 4950 System User's Handbook)

850270

Issue 4 (December 1998)



For any assistance contact your nearest Wavetek Sales and Service Center. Addresses can be found at the back of this handbook.

Due to our policy of continuously updating our products, this handbook may contain minor differences in specification, components and circuit design to the instrument actually supplied. Amendment sheets precisely matched to your instrument serial number are available on request.

© 1998 Wavetek Ltd

WAVETEK is a US registered trademark of Wavetek Corporation.

Wavetek Corporation Standard Warranty Policy

Wavetek warrants that all Products manufactured or procured by Wavetek conform to Wavetek's published specifications and are free from defects in materials and workmanship for a period of one (1) year from the date of delivery to the original Buyer, when used under normal operating conditions and within the service conditions for which they were designed. This warranty is not transferrable and does not apply to used or demonstration products.

The obligation of Wavetek arising from a Warranty claim shall be limited to repairing, or at its option, replacing without charge, any assembly or component (except batteries) which in Wavetek's sole opinion proves to be defective within the scope of the Warranty. In the event Wavetek is not able to modify, repair or replace nonconforming defective parts or components to a condition as warranted within a reasonable time after receipt thereof, Buyers shall receive credit in the amount of the original invoiced price of the product.

Wavetek must be notified in writing of the defect or nonconformity within the Warranty period and the affected Product returned to Wavetek's factory, designated Service Provider, or Authorized Service Center within thirty (30) days after discovery of such defect or nonconformity. Buyer shall prepay shipping charges and insurance for Products returned to Wavetek or its designated Service Provider for warranty service. Wavetek or its designated Service Provider shall pay costs for return of Products to Buyer.

Wavetek shall have no responsibility for any defect or damage caused by improper storage, improper installation, unauthorized modification, misuse, neglect, inadequate maintenance, accident or for any Product which has been repaired or altered by anyone other than Wavetek or its authorized representative or not in accordance with instructions furnished by Wavetek.

The Warranty described above is Buyer's sole and exclusive remedy and no other warranty, whether written or oral, expressed or implied by statute or course of dealing shall apply. Wavetek specifically disclaims the implied warranties of merchantability and fitness for a particular purpose. No statement, representation, agreement, or understanding, oral or written, made by an agent, distributor, or employee of Wavetek, which is not contained in the foregoing Warranty will be binding upon Wavetek, unless made in writing and executed by an authorized representative of Wavetek. Under no circumstances shall Wavetek be liable for any direct, indirect, special, incidental, or consequential damages, expenses, or losses, including loss of profits, based on contract, tort, or any other legal theory.

April 1, 1994

Wavetek Corporation reserves the right to amend specifications without notice.

CONTENTS

	<i>Page</i>
SAFETY ISSUES	
READ THIS ENTIRE SECTION THOROUGHLY BEFORE ATTEMPTING TO INSTALL, OPERATE OR SERVICE THE MODEL 4950 MULTIFUNCTION TRANSFER STANDARD	vi
SECTION 1 INTRODUCTION AND GENERAL DESCRIPTION	
Features	1-1
Closed-Loop Transfer Processes	1-2
Design for System Use	1-6
Operation from the Front Panel	1-8
Calibration; Message Readout; Processor	1-10
Accessories	1-11
Additional Documentation	1-11
Principles of Operation	1-12
Appendix - 10A Current Shunt Model 4953	1-23
SECTION 2 INSTALLATION AND OPERATING CONTROLS	
Unpacking and Inspection	2-1
Calibration Enable Switch S2	2-1
Introduction to the Front Panel	2-2
Introduction to the Rear Panel	2-3
Preparation for Operation	
WARNING	2-4
NOTE: E-M INTERFERENCE	2-4
Line Input Voltage Selector	2-4
Line Power Distribution and Fuse Location	2-5
Positioning of the 4950 to Avoid E-M Interference	2-7
Bench Mounting	2-8
Rack Mounting	2-8
Rack Slide Mounting	2-10
Connectors and Pin Designations	2-13
SECTION 3 BASIC MEASUREMENTS	
The Measurement Task	3-1
Introduction to the Front Panel	3-1
Menu Keys	3-2
Major Function Keys	3-4
Initial State at Power On	3-5
Internal States at Power On	3-6
Operation During Warm-Up	3-7
Soft Key Conventions	3-8
Tour of the Major Function Menus	3-9
Status Key	3-39
Conclusion	3-45

	<i>Page</i>
SECTION 4 USING THE 4950	
Preliminaries	4-1
Interconnections - General Guidelines	4-2
Instrument Configuration	4-4
Instrument Status; Instrument Identity; IEEE 488 Address	4-4
Identifying Traceable Accessories	4-5
Temperature Status	4-6
Calibration Calendar; Monitor Menu - Other Options	4-7
Measurement Definition	4-8
Functions	4-8
DC Voltage	4-8
AC Voltage	4-10
Ohms	4-13
DC Current	4-17
AC Current	4-20
Measurement Parameters	4-25
Accuracy Mode	4-25
Certified and Baseline Corrections	4-26
Measurement Results	4-27
Type of Measurement	4-27
Measurement Quality	4-28
Signal Frequency (ACV & ACI only)	4-29
Selftest Operations	4-30
'Test' Key; Display Test; Keyboard Test	4-30
Confidence Test	4-31
Test Menus - Selection Diagram	4-32
Direct Action Keys	4-33
Calibration Operations	4-34
Section 4 Appendices:	
A Error Detection / Error Messages	4-A1

CONTENTS (Continued)

Page

SECTION 5 SYSTEMS APPLICATION VIA THE IEEE 488 INTERFACE

Section 5 Detailed Contents List	5-0-2
Classified Alphabetical List of IEEE 488.2 Codes used in the 4950	5-0-4
Introduction	5-1
Using the 4950 in a System	5-4
Addressing the 4950	5-4
Remote Operation	5-5
Programming Guidance	5-6
Message Exchange	5-12
Service Request (SRQ)	5-16
Retrieval of Device Status Information	5-17
4950 Commands and Queries - Syntax Diagrams	5-28
Measurement Definition - Major Functions	5-28
Measurement Definition - Measurement Parameters and Results	5-38
Measurement Definition - SRQ Generation	5-43
Trigger Reading	5-44
Measurement Results	5-46
Instrument Configuration	5-51
Status Reporting	5-59
Test Operations	5-73
Internal Operations	5-75
General Queries	5-78
Calibration Commands and Messages	5-80
IEEE 488.2 Device Documentation Requirements	5-A1
4950 Device Settings at Power On	5-B1

SECTION 6 SPECIFICATIONS

Mechanical, Environmental, Electrical, Safety & EMI	6-1
Maximum Input Voltages	6-2
Transfer Specifications	6-3
DC Voltage	6-3
AC Voltage	6-4
Ohms	6-8
DC Current	6-9
AC Current	6-10
Composition of Overall Tolerance of Transfer Measurements	6-14
Other Specifications	6-17
Sample Size and Resolution	6-17

SECTION 7 SPECIFICATION VERIFICATION

Introduction	7-1
General	7-1
Pre- and Post-Transportation Comparisons	7-1
'Transfer Verification'	7-1
Comparison Results	7-1

SECTION 8 CERTIFIED CALIBRATION

Introduction	8-1
General	8-1
Autocal	8-1
General Outline of Calibration Operations	8-2
The CAL Menu	8-2
CAL Group of Menus - Overall View	8-3
Preparation	8-4
Calibration Setup	8-6
Frequency Calibration	8-8
DC Voltage Calibration	8-10
AC Voltage Calibration	8-12
DC Current Calibration	8-14
AC Current Calibration	8-18
Ohms Calibration	8-23
Calibration - Conclusion	8-28

SAFETY ISSUES

READ THIS ENTIRE SECTION THOROUGHLY BEFORE ATTEMPTING TO INSTALL, OPERATE OR SERVICE THE MODEL 4950 MULTIFUNCTION TRANSFER STANDARD

General Safety Summary

This instrument has been designed and tested in accordance with the British and European standard publication EN61010:1993/A2:1995, and has been supplied in a safe condition.

This manual contains information and warnings that must be observed to keep the instrument in a safe condition and ensure safe operation. Operation or service in conditions or in a manner other than specified could compromise safety. For the correct and safe use of this instrument, operating and service personnel must follow generally accepted safety procedures, in addition to the safety precautions specified.

To avoid injury or fire hazard, **do not** switch on the instrument if it is damaged or suspected to be faulty. **Do not** use the instrument in damp, wet, condensing, dusty, or explosive gas environments.

Whenever it is likely that safety protection has been impaired, make the instrument inoperative and secure it against any unintended operation. Inform qualified maintenance or repair personnel. Safety protection is likely to be impaired if, for example, the instrument shows visible damage, or fails to operate normally.

WARNING THIS INSTRUMENT CAN DELIVER A LETHAL ELECTRIC SHOCK. NEVER TOUCH ANY LEAD OR TERMINAL UNLESS YOU ARE ABSOLUTELY CERTAIN THAT NO DANGEROUS VOLTAGE IS PRESENT.



Explanation of safety related symbols and terms

DANGER electric shock risk



The product is marked with this symbol to indicate that hazardous voltages (>30 VDC or AC peak) may be present.

CAUTION refer to documentation



The product is marked with this symbol when the user must refer to the instruction manual.

Earth (Ground) terminal

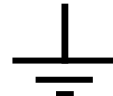

Functional Earth (Ground) only - must not be used as a Protective Earth.

WARNING WARNING STATEMENTS IDENTIFY CONDITIONS OR PRACTICES THAT COULD RESULT IN INJURY OR DEATH.

CAUTION CAUTION STATEMENTS IDENTIFY CONDITIONS OR PRACTICES THAT COULD RESULT IN DAMAGE TO THIS OR OTHER PROPERTY.

Protective Earth (Ground)

Protection Class I:

The instrument **must** be operated with a Protective Earth/Ground connected via the power cable's protective earth/ground conductor. The Protective Earth/Ground connects to the instrument before the line & neutral connections when the supply plug is inserted into the power socket on the back of the instrument.

WARNING ANY INTERRUPTION OF THE PROTECTIVE GROUND CONDUCTOR INSIDE OR OUTSIDE THE INSTRUMENT IS LIKELY TO MAKE THE INSTRUMENT DANGEROUS.



To avoid electric shock hazard, make signal connections to the instrument after making the protective ground connection. Remove signal connections before removing the protective ground connection, i.e. **the power cable must be connected whenever signal leads are connected.**

Do Not Operate Without Covers

To avoid electric shock or fire hazard, **do not** operate the instrument with its covers removed. The covers protect users from live parts, and unless otherwise stated, must only be removed by qualified service personnel for maintenance and repair purposes.

WARNING



REMOVING THE COVERS MAY EXPOSE VOLTAGES IN EXCESS OF 1.5kV PEAK.

Safe Operating Conditions

Only operate the instrument within the manufacturer's specified operating conditions. Specification examples that must be considered include:

- ambient temperature
- ambient humidity
- power supply voltage & frequency
- maximum terminal voltages or currents
- altitude
- ambient pollution level
- exposure to shock and vibration

To avoid electric shock or fire hazard, **do not** apply to or subject the instrument to any condition that is outside specified range. See Section 6 of this manual for detailed instrument specifications and operating conditions.

CAUTION CONSIDER DIRECT SUNLIGHT, RADIATORS AND OTHER HEAT SOURCES WHEN ASSESSING AMBIENT TEMPERATURE.



CAUTION BEFORE CONNECTING THE INSTRUMENT TO THE SUPPLY, MAKE SURE THAT THE REAR PANEL AC SUPPLY VOLTAGE CONNECTOR IS SET TO THE CORRECT VOLTAGE (115V OR 230V) AND THAT THE CORRECT FUSES ARE FITTED.



Fuse Requirements

To avoid fire hazard, use only the fuse arrangements that appear in the fuse specification tables (*see next page*). Additionally, the supply network must be fused at a maximum of 16A, and in the UK, a 13A fuse must be fitted in the power cable plug.

Fuse Requirements (continued)

F1 Power Input Fuse, Instrument

Supply (Line) Voltage Selection	Fuse Action	Fuse Rating IEC (UL/CSA)	Wavetek Part No.	Manufacturer & Type No.
115 VAC	T Time delay	1 A (1.4 A)	920116	Littlefuse 215001
230 VAC	TH Time delay HBC	500 mA (700 mA)	920084	Littlefuse 215.500

F2 Current Function Fuse

Fuse Action	Fuse Rating IEC (UL/CSA)	Wavetek Part No.	Manufacturer & Type No.
FH Fast acting HBC	1.6 A (2.0 A)	920071	Beswick S501/1.6A

F3 Power Input Fuse, System

Supply (Line) Voltage Selection	Fuse Action	Fuse Rating UL/CSA (IEC)	Wavetek Part No.	Manufacturer & Type No.
115 VAC	T Time delay	10 A (7 A)	920175	Littlefuse 326010
230 VAC	TH Time delay HBC	6.25 A (5 A)	920114	Littlefuse 3266.25

The Power Cable and Power Supply Disconnection

The intended power supply disconnect device is the ON/OFF switch that is located on the instrument's front panel. The ON/OFF switch **must** be readily accessible while the instrument is operating. If this operating condition cannot be met, the power cable plug or other power disconnecting device **must** be readily accessible to the operator.

To avoid electric shock and fire hazard, make sure that the power cable is not damaged, and that it is adequately rated against power supply network fusing. If the power cable plug is to be the accessible disconnect device, the power cable must not be longer than 3 metres.

Instrument Terminal Connections

Make sure that the instrument is correctly protectively earthed (safety grounded) via the power cable before and while any other connection is made.

Installation Category I:

Measurement and/or guard terminals are designed for connection at Installation (Overvoltage) Category I. To avoid electric shock or fire hazard, the instrument terminals must not be directly connected to the AC line power supply, or to any other voltage or current source that may (even temporarily) exceed the instrument's peak ratings.

WARNING TO AVOID INJURY OR DEATH, DO NOT CONNECT OR DISCONNECT SIGNAL LEADS WHILE THEY ARE CONNECTED TO A HAZARDOUS VOLTAGE OR CURRENT SOURCE. ALWAYS ENSURE THAT SIGNAL LEADS ARE IN A SAFE CONDITION BEFORE HANDLING.



Maintenance and Repair

Observe all applicable local and/or national safety regulations and rules while performing any work. First disconnect the instrument from all signal sources, then from the AC line supply before removing any cover. Any adjustment, parts replacement, maintenance or repair should be carried out only by authorised Wavetek technical personnel.

WARNING FOR CONTINUED PROTECTION AGAINST INJURY AND FIRE HAZARD, USE ONLY MANUFACTURER SUPPLIED PARTS RELEVANT TO SAFETY. SAFETY TESTS MUST BE PERFORMED AFTER REPLACING ANY PART RELEVANT TO SAFETY.



Moving

First disconnect the instrument from all signal sources, then from the AC line supply before moving the instrument.

Cleaning

First disconnect the instrument from all signal sources, then from the AC line supply before cleaning. Use only a damp, lint-free cloth to clean fascia and case parts.

Observe any additional safety instructions or warnings given in this manual.

4950 MULTIFUNCTION TRANSFER STANDARD

SECTION 1

Introduction and General Description

Designed specifically to calibrate DC and LF calibrators at standard target values, the 4950 provides high-performance, traceable transfer measurements in DC Voltage, AC Voltage, DC Current, AC Current and Resistance.

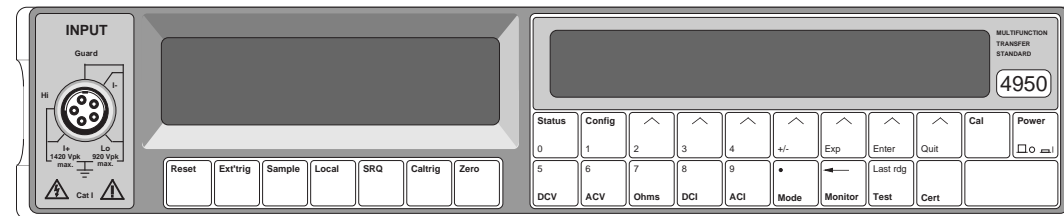

Features

The 4950 is a self-contained, programmable Transfer Standard, capable of fully-traceable, high-accuracy calibration of the latest generation of high-performance multifunction calibrators.

- **Wide Application** - supports all Datron models, and other manufacturers' calibrators.
- **Transfer Traceability** - transfers traceable accuracy directly to the calibrator output terminals for all ranges, and functions.
- **Fully Automated** - provides full automation of calibration process and data for Statistical Process Control techniques to define tailored certification intervals. Operates in industry-standard PC environment.
- **Portability** - specifically designed and constructed for extensive travel.
- **Cost-Effective** - provides 'in-situ' calibration, drastically reducing calibrator downtime.
- **Tight Verification** - closed-loop process for calibrating a calibrator.

Closed-Loop Transfer Processes

Introduction

Where does the 4950 Normally Reside?

The 4950 is designed to transfer multifunction traceability from Standards Laboratory to Calibrator, sometimes over considerable distance. It may be owned by, and reside with, the user organization which also owns the calibrator, or it may form part of a calibration service bought by the user, being owned by the service operator.

Open-Loop Transfer

In either case, traceable accuracy flows from the Standards Laboratory to the user's calibrator. This is also true for a system in which the calibrator is sent away for its own calibration, a normal arrangement in which the transfer is open-loop, relying on the stability and reliability of the calibrator to avoid damage

or excessive drift in transit. The down-time due to the calibrator's absence causes a break in the calibrator use, sometimes causing a user to obtain duplicate facilities.

Closed-Loop Transfer

As well as being specially designed to withstand travel in normal freight channels, the 4950 makes it possible to close the loop by checking its drift due to transit. To do this it retains its original adjustment factors, known as 'Baseline Corrections' which are not affected by calibration to the standard, and so its performance before travelling can be compared with that after it returns. A major advantage is the reduction of calibrator downtime, by employing a parallel process to effect the transfer, while the calibrator remains in use.

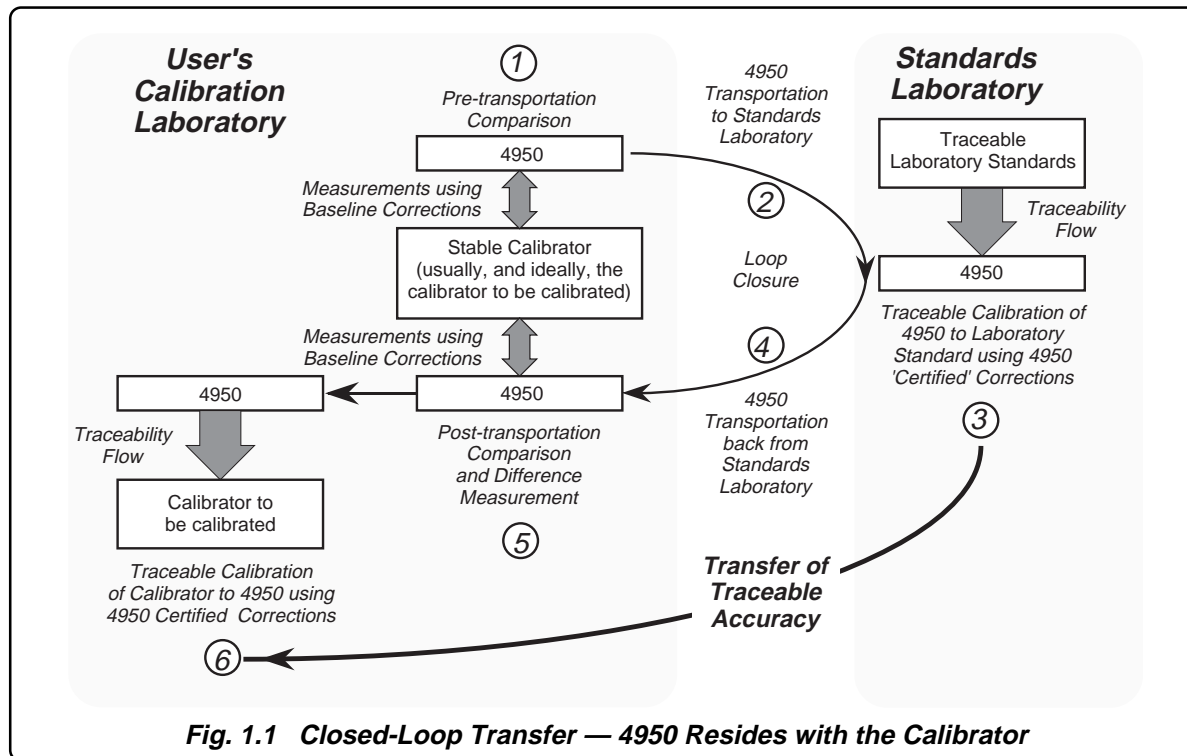

Fig. 1.1 Closed-Loop Transfer — 4950 Resides with the Calibrator

Two Ways to Close the Loop

User Owns the 4950 (Fig. 1.1)

The 4950 normally resides in the user's calibration laboratory, and will need to be sent to the standards laboratory for its 'Certified Corrections' to be updated to traceable standards. Then it is sent back to calibrate the user's calibrator(s).

To check whether there has been excessive drift during transit, or whether it has been damaged, All functions and ranges of the 4950 are checked before transportation to the standards laboratory then again on its return. This is done by comparison with a stable device in the user's laboratory, most probably the calibrator it is to calibrate, or the most stable one (the 'check' calibrator) if there are a number. For the best results, the check calibrator should be left switched on in the same environment while the 4950 is away.

There are really two processes here:

1. *Baseline Comparison Loop:*

Stages 1, 2, 4 & 5

This checks the performance of the 4950 against the same device before and after travelling to and from the Standards Laboratory, using only the invariant Baseline corrections for the 4950.

Because the 4950 can be involved in calibrating one or more calibrators on return from its visit to the Standards Laboratory, the (historically) most stable calibrator should be used for the Baseline comparisons.

2. *Certified Calibration:*

Stages 3, 4 & 6

The Certified corrections are updated by calibrating the 4950 at the Standards Laboratory, returning with the 4950 to calibrate the owner's calibrator(s). Note that the post-transportation comparison stage 5 (process 1) *must* be carried out before the calibration stage 6 (process 2).

The only difference between the 4950 configuration in each process is the type of corrections applied to the measurements. The 4950 hardware, firmware and internal processes remain identical.

A one-to-one dependency therefore exists between the measurements taken in the comparison loop and in certified calibration, justifying the complementary use of the two processes to convey traceability.

Because the same 4950 will be used by the owner of the calibrator(s) for subsequent calibrations, a history can be built up over a number of calibration cycles. This generates confidence in the performance of the overall system. Such confidence can lead to the introduction of 'Statistical Process Control' (SPC), which can increase the period between calibrations, improving the efficiency of all processes.

The second method of closing the loop is described overleaf.

Two Ways to Close the Loop (Contd.)

4950 Resident in the Standards Laboratory (Fig. 1.2)

When the 4950 resides in the standards laboratory of an organization offering a calibration service, it will need to be calibrated and certified at the user's target values, and sent to the user's calibration laboratory for Certified calibration of calibrator(s). Then it is sent back to the standards laboratory.

To check whether there has been excessive drift during transit, or whether it has been damaged, All functions and ranges of the 4950 are checked before transportation to the user, then again on its return. This is done by comparison with stable standards (check standards) in the standards laboratory. For the best results, the check standards should remain switched on in the same environment while the 4950 is away.

Again, there are two processes (Fig 1.2):

1. *Baseline Comparison Loop:* **Stages 2, 3, 5, 6 & 7**

This checks the performance of the 4950 against the same device before and after travelling to and from the User's Laboratory, using only the invariant Baseline corrections for the 4950, which were stored at manufacture.

2. *Certified Calibration:* **Stages 1, 3, 4 & 7**

The stored Certified corrections are updated by calibrating the 4950 at the Standards Laboratory, then sending the 4950 to calibrate the owner's calibrator(s).

The only difference between the 4950 configuration in each process is the type of corrections applied to the measurements. The 4950 hardware, firmware and internal processes remain identical.

A one-to-one dependency therefore exists between the measurements taken in the comparison loop and in certified calibration, justifying the complementary use of the two processes to convey traceability.

User-confidence in the calibration comes from the confirmation that the baseline loop comparison was successful. Therefore the communication at stage 7 is essential in the process. From the user's point of view, the process is open-loop until this report has been given.

As for the user-owned case, an integral history can be built up over a number of calibration cycles, but if the same 4950 is not used, then the traceable uncertainty will increase, reducing confidence.

Also, for the previous case of user-ownership, by dedicating the 4950 to calibrators in the user's laboratory; extra certified comparisons between calibrators and the resident 4950 can be interposed. This will give higher confidence and more detailed trend data for Statistical Process Control.

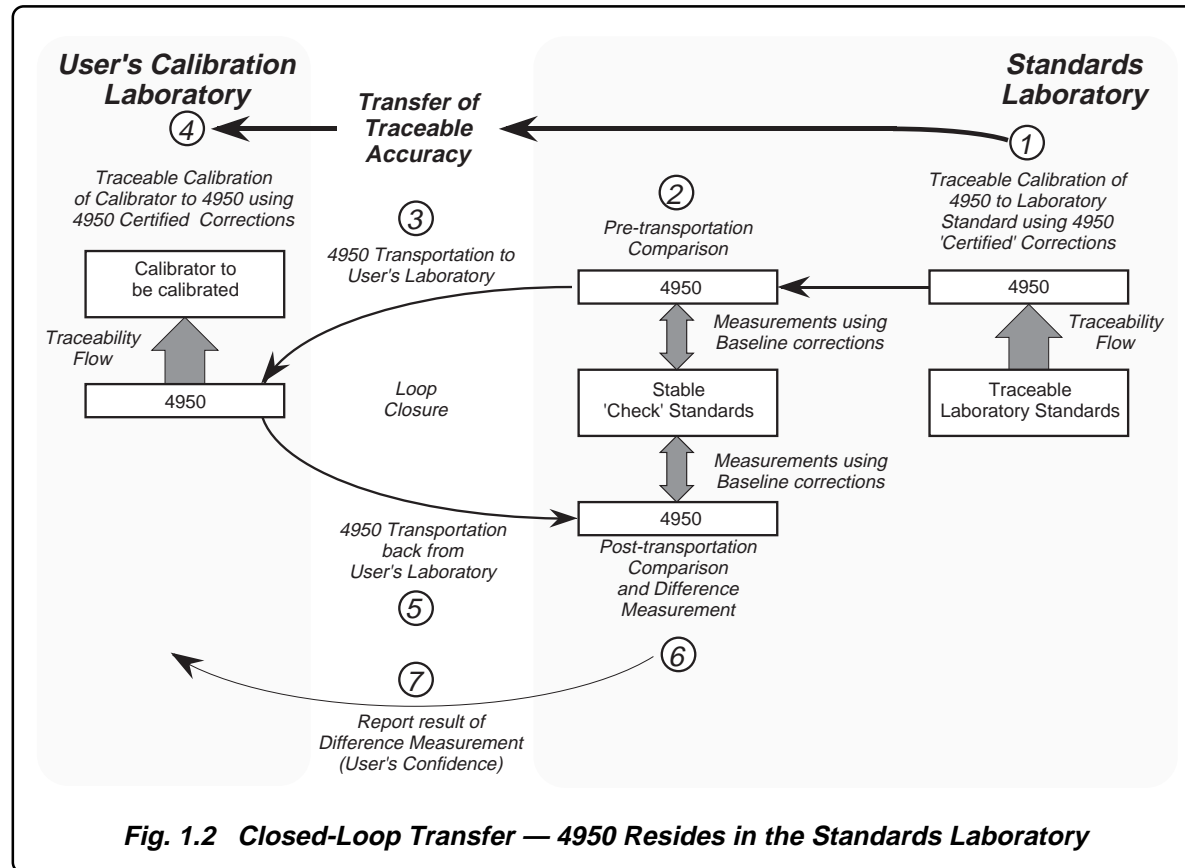

Design for System Use

Introduction

Many operations are necessary to complete all the processes required for traceable calibration of a calibrator, on all its functions and ranges. The two scenarios described on *pages 1-2 to 1-5* each involve four complete sets of measurements. Calibrating manually from the front panel can be time-consuming, with distinct possibilities of operator-error, so automation of the processes will bring several benefits.

The 4950 is therefore designed primarily to form part of a remote control system, conforming to IEEE 488.2 Standard Digital Interface.

Remote control information is given in *Section 5*. This data fulfils the Device Documentation Requirements of the standard (summary in *Section 5 Appendix A*).

To simplify remote operation, a suite of software programmes has been constructed which can drive the 4950 and a multifunction calibrator through all the 'Closed Loop Transfer Processes' described on *pages 1-2 to 1-5*.

Transfer Process — Automated Control

The application software for calibration of Datron calibrators runs on hardware which meets the following criteria:

Minimum Computing Hardware:

Host computer: PC compatible with 80286 processor, 12MHz clock, 4MB of RAM, keyboard and mouse operation;

Operating System: DOS 3.31 or later, Microsoft Windows version 3;

Hard Disk: 20Mbyte;

Floppy Disk: 3.5" or 5.25";

Monitor: VGA (color or mono);

Printer: 9-pin dot-matrix.

Program Functions

The software suite is divided into two main programs, which run in the MS-Windows environment. The following selections are available within the programs:

1. **CAL-CAL.ATS** is used to perform baseline comparisons and certified calibration or verification of the calibrator to the 4950.
 - a. **Pre-Transportation** performs the Pre-transportation baseline comparison, and stores the results.
Page 1-2, Fig 1.1, Stage 1;
Page 1-5, Fig 1.2, Stage 2.
 - b. **Post-Transportation** performs the Post-transportation baseline comparison, and creates a file which stores the differences between the pre- and post-transportation results.
Page 1-2, Fig 1.1, Stage 5;
Page 1-5, Fig 1.2, Stage 6.
 - c. **Verify and Adjust** drives both calibrator and 4950 to correct the calibrator, on all or a selection of its functions, using the certified corrections of the 4950.
Page 1-2, Fig 1.1, Stage 6;
Page 1-5, Fig 1.2, Stage 4.
 - d. **Verify** drives both calibrator and 4950 to check the traceable accuracy of the calibrator, on all or a selection of its functions, using the certified corrections of the 4950.
Page 1-2, Fig 1.1, Stage 6;
Page 1-5, Fig 1.2, Stage 4.
2. **MTS-CAL.ATS** is used to perform certified calibration or verification of the 4950 to the Laboratory Standards.
 - a. **Verify and Adjust** drives both the traceable Laboratory Standards and the 4950 to modify the certified corrections of the 4950, on all or a selection of its functions.
Page 1-2, Fig 1.1, Stage 3;
Page 1-5, Fig 1.2, Stage 1.
 - b. **Verify** drives both the traceable Laboratory Standards and the 4950 to check but not modify the certified corrections of the 4950, on all or a selection of its functions.
Page 1-2, Fig 1.1, Stage 3;
Page 1-5, Fig 1.2, Stage 1.

Operation from the Front Panel

General

Although the 4950 is designed primarily for system operation, over a wide range of functions and values, it is often required to operate from the front panel.

'Hard' and 'Soft' Keys - Menus

Hard keys (labels printed on the keys) and soft keys (labels on the separate 'menu' display) allow the 4950 to be configured for a wide range of operations.

The hard key of one of the main functions (DCV, ACV, Ohms, DCI or ACI) selects the relevant circuitry, at the same time displaying its own menu. Once a main function is active, the **Config** hard key can be used to alter the configuration. Each soft key is marked with an arrowhead (↖), pointing to its label in the menu display.

The **Status** hard key present a list of configured parameters on the menu display (function, range, band, accuracy mode and type of correction). During any warm-up period, the Status display shows the time remaining to stabilization. With Status selected, the **Config** hard key can be used to view or alter the IEEE-488 bus address, or to check the serial numbers of the instrument, the 4-wire Ohms lead and the 10A shunt.

The **Monitor** key permits access to such information as internal temperature states; the signal frequency of an AC input signal being measured; Baseline and Certified calibration dates; the present time; and reading quality.

The **Test** key displays a menu which provides access to a series of selftests.

- A confidence selftest;
- A test of the displays;
- A test of the front panel keys;

Details of these selftests can be found in Section 4 of this handbook. The confidence selftest can also be carried out under remote control via the IEEE 488 interface.

The **Cert** key displays a menu for a user to choose either Certified or Baseline corrections, which will then be applied to all measurements. The choice can also be made under remote control via the IEEE 488 interface.

Menu Structures

The menus are arranged in tree structures, leading the user through their branches to an end node, at which the physical circuitry or software selections of the instrument can be changed to suit the required parameters. For ease of use, each track from main function to end node involves the minimum number of user selections.

Switching instrument power ON forces all functions into a safety default state for a stabilizing warm-up period (initially 6 hours). Users have full access to the functions and facilities of the instrument during this warm-up.

Except for 2-wire measurement on the 1V and 10V ranges of the AC Voltage function; once a function or range is configured to a required state it remains in that state, regardless of subsequent configurations in other functions, until either the state is changed or the instrument power is switched off. On returning to each function or range, the most-recently configured state is restored. In the exceptional case of 2-wire measurement as referred above, any change of frequency band or range will default permanently to 4-wire measurement.

As an introduction to the main function keys and their associated menus, users can follow a guided tour through the main tree structures, sequenced in Section 3. The full range of facilities, together with access information, is detailed in Section 4.

Calibration

Autocal

The 4950 provides full external calibration of all ranges and functions from the front panel; thus making the removal of covers unnecessary.

As part of the transfer process, the 4950 is electronically calibrated against traceable external standards, where any differences between the instrument's readings and the value of the standards can be used to derive 'Certified' corrections. These are stored in non-volatile memory, and later serve to correct all 4950 measurements when calibrating a calibrator.

The 4950 is primarily designed to be calibrated under remote control via the IEEE 488 interface. A suite of programs (MTS Software pack) is available, providing comprehensive operating facilities.

Calibration Security

A recessed Calibration Enable/Disable switch on the rear panel prevents accidental use of the Calibration mode. For remote operation; in addition to operating the Enable/Disable switch, an 'enable' command is required to gain access to calibration operations.

Calibration Commands and Routines

The effects of hard and soft keys, when in Calibration mode, are described in *Section 4*. The IEEE-488.2 calibration commands are detailed in *Section 5*. Routine Calibration procedures appear in *Section 8*.

Message Readout

Generally, the selections offered in the menus reflect the availability of facilities, incompatible combinations being excluded. Nevertheless, the menu display doubles as a message screen, giving a clear readout of information to the user such as unsuitable attempts at configuration, test failures and some other conditions which would need to be reported to a Datron service center.

Processor

The instrument is internally controlled by a 68000 series microprocessor. It ultimately translates all information, either from the front panel keys or from remote control, according to its program in firmware, into control signals which determine the instrument's operation.

Accessories

The instrument is supplied with the following accessories:

Description	Part Number
Power Connector Cable (L1949)	920012
Input Cable Assembly	401035
Power Fuse (230V use) T500mAH (see Safety Issues section)	920084
Power Fuse (115V use) T1.0AH (see Safety Issues section)	920116
Hex Key 1.5mm AF (Handle removal)	630284
4950 System User's Handbook	850280
4950 Instrument User's Handbook	850270
User's Quick Reference Guide	850914
Ruggedized Transit Case	401072
Control Software 4951	401073

Optional Accessories

The following accessories can be purchased for use with the 4950:

Description	
Option 80: 115V, 60Hz Line Supply (no charge)	
Option 81: 115V, 50Hz Line Supply (no charge)	
Option 90: Rack Mounting Kit	440153
Option 95: Rack Slide Kit	440163
Model 4953: 10A Shunt	401034

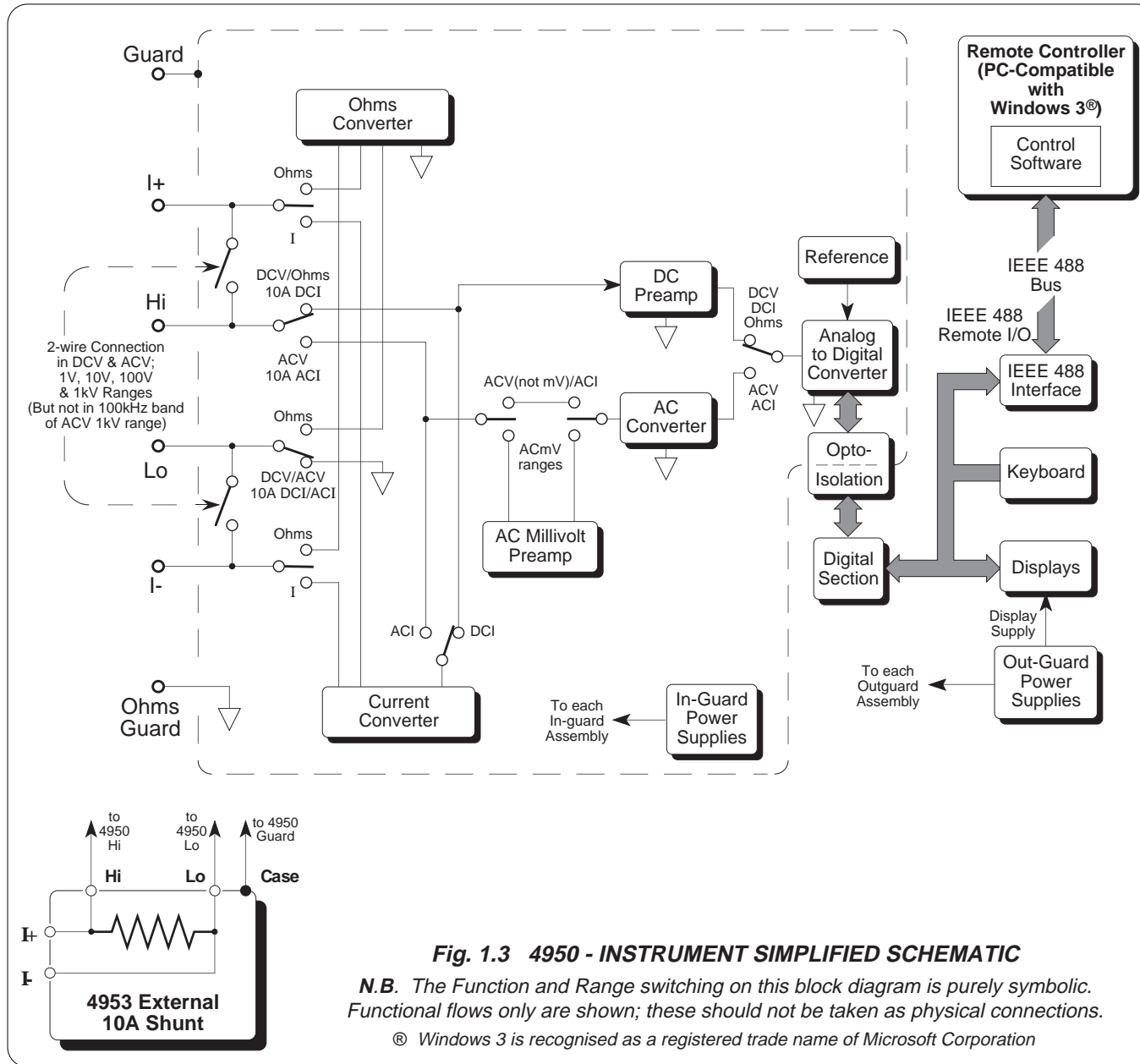

Principles of Operation

Precision MTS Design

Introduction

The 4950 Multifunction Transfer Standard is designed for calibration and standards laboratory applications, and so takes full advantage of the inherent qualities of critical accuracy-defining components to achieve its high performance. It

also employs a method of calibration which is designed to enhance performances across the entire range of its functions. *Figure 1.3* shows how the instrument achieves its basic measurement functions.

Basics

DC Voltage measurements are made by passing the input signal to a DC amplifier, which amplifies or attenuates the signal to a level compatible with the input requirements of the Analog to Digital converter (A-D). The reading from the A-D is then transferred to the instrument's microprocessor for calibration and display.

AC Voltage inputs are conditioned by the AC preamp and a precision full-wave rectifier. The rectified signal is applied to an electronic RMS converter, which generates an accurate DC analog of the signal's RMS value. This DC level is digitized by the A-D converter.

On AC millivolt ranges the input signal is first conditioned by a preamplifier whose gain is characterized at x30. Its output is applied to the ACV input circuitry, whose gain is configured for each millivolt range so as to present a standard (full range) input of 9V to the A-D converter.

Resistance is measured by passing a constant current through the resistor under test and measuring the DC voltage that develops across it, using the DC Voltage circuits of the instrument.

DC or AC currents pass through precision internal shunts; the voltages that develop are measured using the DCV or ACV sections of the instrument.

The Role of the 4950 MTS

As described earlier, the 4950 is intended for use in closed-loop processes, transferring traceability from a set of prime standards to remote calibrators.

These transfers are not carried out over the whole span of the calibrators' functions and ranges, but are limited to target values (usually cardinal values). So the 4950 does not measure the full span of any calibrator range; its accuracy is improved by confining measurements to narrow target bands (usually $\pm 10\%$ of the nominal target value).

In AC functions, the measurement is also restricted into frequency bands (usually $\pm 10\%$ of the target frequency). This reduces flatness errors across the frequency band.

All value bands are calibrated separately, (in AC functions, separately within each frequency band). The use of mark-period control of output value in modern calibrators permits complete linearity correction to result from a single full scale correction on one range (nominally 190%FR).

To benefit from common analog characteristics, the value bands are grouped to match those of the Datron and other popular calibrator models.

All the functions, value ranges, value bands and frequency bands can be accessed via the remote IEEE-488 interface.

Analog to Digital Converter

Introduction

The instrument's analog-to-digital converter (A-D) takes the form of a highly linear, low noise, fast and flexible multislope integrator. Timing, counting and control are executed by a custom 'Application-

Specific Integrated Circuit' (ASIC). A simplified schematic is given as *Fig. 1.4*. The A-D is involved in every measurement in ACV, mV and AC/DC operation.

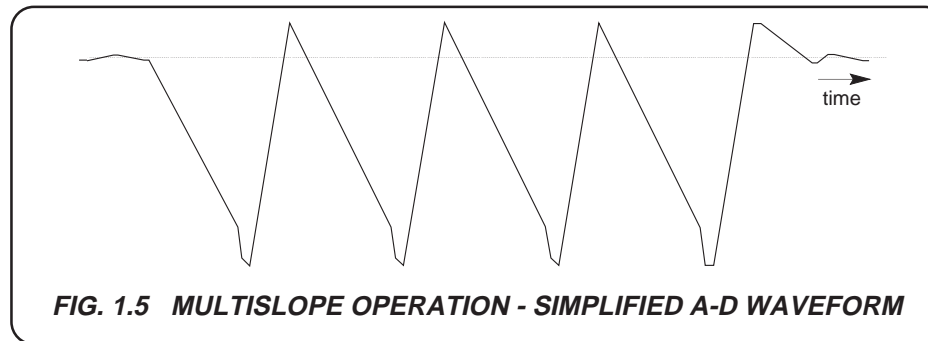
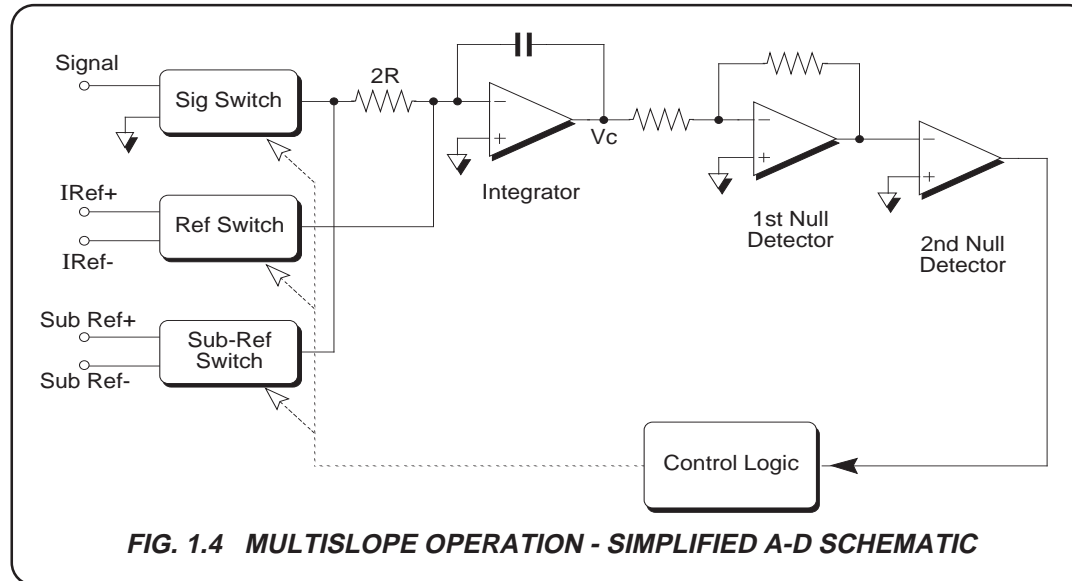

Multislope Operation (Figs. 1.4 and 1.5)

Multislope operation permits the integration capacitor value to be smaller than normally required for a more conventional circuit, greatly reducing problems due to dielectric absorption. Reference switching errors are reduced to a constant value, which are subtracted from the reading by the instrument's microprocessor. A further benefit is that both the signal and the reference may be applied to the integrator simultaneously, greatly reducing the conversion time. A digital autozero system avoids the need for the more common sample-and-hold type of autozero circuit.

The timing and counting considerations with this design of A-D are quite complex. Programmable delay timers, a ramp timer and a counter for the number of completed ramps exercise great control flexibility over its performance. All of these timers and counters are integrated into a custom ASIC which includes a 32 bit control register, programmed by the instrument's microprocessor via a special serial interface. The same serial loop is used to transmit the reading from the ASIC to the processor for calibration and display.

A-D Features

The result is a compact A-D with the following features:

- Excellent rejection of normal-mode power-line interference (Integration time is fixed at 200ms, an exact multiple of 60Hz and 50Hz line supply periods).
- Excellent linearity.
- Low noise of < 0.05ppm of full scale.

A-D Master Reference

Reference Module

The reference used in the analog to digital conversion is derived from a specially conditioned zener reference module. It contains the reference device and its associated support circuits. The module is stable to within ± 4 ppm per year, produces pk-pk noise less than 0.1ppm, and has a temperature coefficient better than 0.15ppm/ $^{\circ}$ C. This temperature coefficient is held over a temperature span of 0 $^{\circ}$ C to 70 $^{\circ}$ C, and the reference exhibits negligible temperature shock hysteresis.

Module History

Extensive evaluation of successive reference modules has resulted in a burn-in process which equates to an ageing of 1 year, reducing infant mortalities and improving stability. Following this process, all reference modules are checked over a temperature span of 0 $^{\circ}$ C to 70 $^{\circ}$ C for temperature performance, and then monitored for long term drift over a period of three months minimum.

DC Voltage

DC Preamplifier (Fig. 1.6)

Basic Design

The required input characteristics are achieved by using a differential FET input to give low input current characteristics, coupled with a multistage design to ensure good bandwidth and overall gain characteristics. This basic design is enhanced by employing the amplifier in a synchronized chopper configuration. Noise is also reduced by this method. A second amplifier stage provides most of the forward gain with the frequency gain-compensation necessary to give an effective amplifier bandwidth of 1MHz.

Ranges

Extremely stable resistance units in the range switching network and input attenuator configure the DC amplifier gain to define the DC Voltage ranges. To ensure that no spurious leakage currents cause linearity, temperature-coefficient or drift problems in the attenuator chains; the pcb tracks connecting the resistor units to the circuit are carefully guarded.

Effects of Bootstrap

To give a high input impedance, the DC amplifier also drives a bootstrap buffer. This forces the potential of guarding tracks (that surround the Hi input track) to follow the input voltage. Also, each in-guard supply used to power the DC amplifier is made to track the input signal level by reference to bootstrap. The DC amplifier thus sees no change in input signal relative to its supplies, so achieving a very high common mode rejection, eliminating any potential common mode non-linearities.

Protection

The instrument can measure up to 1000V and can withstand a continuous overload of 1000V on all DCV ranges. Back to back zener diodes and a series resistor provide protection for the DC amplifier. Further dynamic protection is provided in the form of larger series resistors in the input attenuator, which switch in when the signal exceeds a certain threshold.

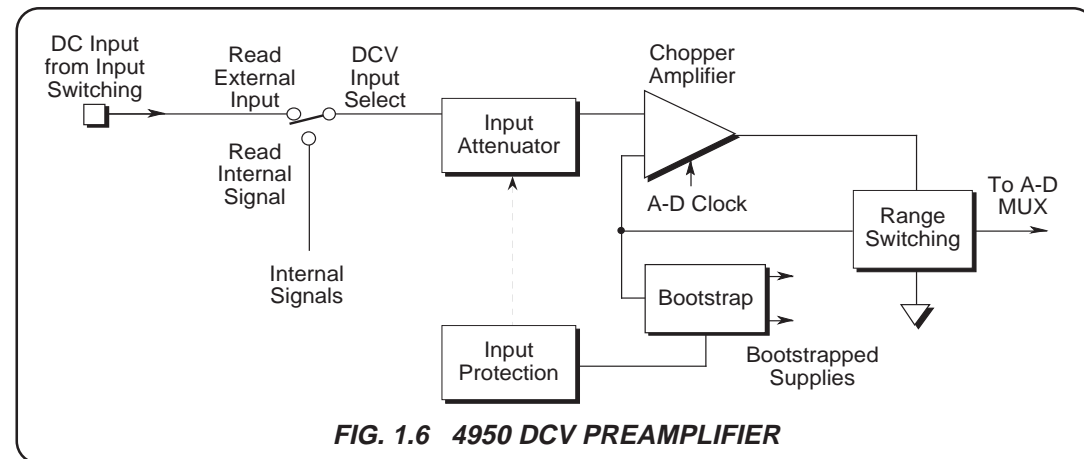

AC Voltage Operation

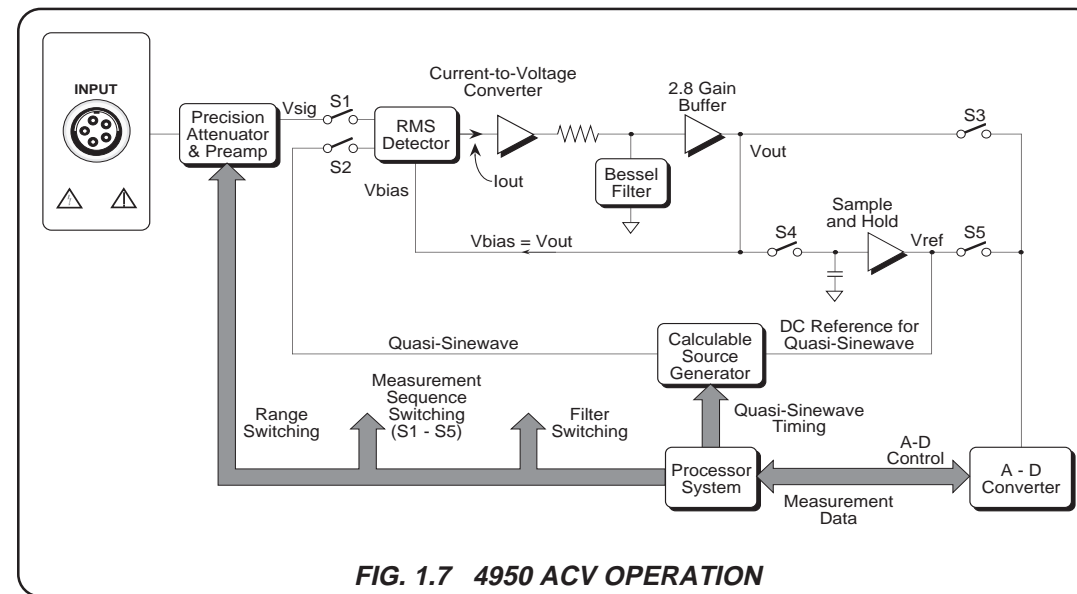

Attenuators and Preamp

Basic Design (Fig. 1.7)

The basic design incorporates a DC-coupled preamplifier, which has relatively high input impedance (124k Ω /150pF on the 3V to 100V ranges; otherwise 404k Ω /90pF). The gain-defining resistor chains are guarded, and the remaining time constants are set above 1MHz so that hardware trims are not required.

Range Selection

There are three main attenuators:

1. A permanent 1kV/300V attenuator for overload sensing;
2. A 100V/30V/10V/3V attenuator, switched in parallel with the 1kV/300V attenuator;
3. A 1V/300mV attenuator in the unity gain buffer, in series with the 1kV/300V attenuator.

Attenuator Elements

The attenuators, which configure the amplifier gain to define the high-accuracy AC Voltage ranges, consist of extremely stable metal foil resistors, packaged in large hermetic-seal cases. Similar types are used in the 1V range protection chain.

To ensure that no spurious leakage currents cause linearity, temperature-coefficient or drift problems in the attenuator chains, the sealed cases form a guard at HF, driven by a capacitor chain. Within the cases of the attenuator elements, the resistor values are split and the junctions guarded to effect a high degree of frequency flatness.

AC Voltage Operation (Contd.)

Attenuators and Preamp (Fig. 1.7)

DC Coupled Preamp

In order to minimize the input capacitance to the preamp, reed relays are used to select the signal paths for the various ranges. The preamp bootstraps extensive pcb tracking to guard the attenuators, input tracking and reed relays; it also drives a bootstrap buffer which forces the preamp power supplies to follow the input signal level by reference to bootstrap. The preamp thus sees no change in input signal relative to its supplies, again minimizing its input capacitance and achieving very high common mode rejection.

Separate PCB

The whole attenuator and preamp circuit is mounted on a separate sub-assembly, mounted above the main High Accuracy ACV printed circuit assembly.

The preamp is run at unity or X3 gain depending on range selection, with corresponding compensation switching. Its output voltage is fed to the RMS Converter on the High Accuracy ACV printed circuit assembly, from which the compensation current for the preamp signal current into the signal ground (0V-4) is derived.

Protection

The instrument can measure up to 1100VRMS and can withstand a continuous overload of 1100VRMS or 1556V peak. Overload is sensed by a resistor at the low end of the 1000V/300V attenuator; and protection is activated from the HIACC_AC pcb. Two series resistors, referred to two zener diodes, absorb the overload energy for up to 1 second, by which time the protection system will have disconnected the instrument input from both the 100V/30V/10V attenuator and the preamp input.

RMS Converter

Conversion Process

RMS conversion is based on a modified analog multiplier, consisting of a 'squaring' logarithmic amplifier whose output is buffered into a balanced exponential amplifier.

The DC current output of the squaring circuit 'Iout' is proportional to 'Vin²' if a fixed source-current bias is applied to the logging and antilogging elements. The transfer function is

$$I_{out} \propto V_{in}^2 / (R^2 \times I_{bias})$$

where **R** is the common value of balanced source resistors and **I_{bias}** is the common source-bias current for the logging and antilogging circuits.

Iout is converted into a DC voltage **Vout** which ultimately becomes the RMS Converter output. However, in order to apply the 'square-root' element of the computation, this voltage is fed back to provide a current bias whose amplitude follows Iout, and this forces Iout to a value proportional to $\sqrt{V_{in}^2}$.

The transfer function now becomes

$$I_{out} \propto V_{in}^2 / (R^2 \times I_{out})$$

as R is constant this leads to $I_{out}^2 \propto V_{in}^2$, and to $I_{out} \propto \sqrt{V_{in}^2}$. After current-to-voltage conversion and filtering, this gives $V_{out} \propto \sqrt{V_{in}^2}$ as the DC output voltage fed to the A/D, subject only to calibration.

Transfer Loop

Transfer Process (Fig. 1.7)

Three internal measurements are made to determine the precise RMS value of the signal. The first is an estimate (to about 1%) which is also a function of the gain of the RMS Converter. The other two are used to determine that gain and then apply corrections to the first measurement.

Calculable Source Generator

The Sample-and-Hold circuit provides a memory of V_{out} , to be used as reference for the Calculable Source Generator. This in turn constructs a 'quasi-sinewave' whose amplitude and form factor are known, in order to ensure that the transfer is a true AC to AC process.

Transfer Sequence Switching

Figure 1.7 shows the arrangement of the elements in the loop. The positions of switches S1-S5 are altered by firmware to generate the three-measurement sequence:

First Measurement (M1):

The uncorrected RMS value of the input signal (V_{sig}) is measured directly by the A-D and processor. The DC analog value of V_{out} (V_{ref}) is memorized in the Sample-and-Hold circuit:

S1 closed drives the RMS Converter from V_{sig} ;

S2 open prevents the quasi-sinewave from interfering with the measurement;

S3 closed the A-D and processor evaluate the first estimate;

S4 closed V_{out} is sampled;

S5 open removes V_{ref} from the direct measurement of the input.

Second Measurement (M2):

V_{ref} from the previous measurement (M1) is measured by the A-D and processor. Meanwhile, the quasi-sinewave (resulting from V_{ref}) is applied to the RMS converter to allow settling for the next measurement (M3).

S1 open V_{sig} is removed;

S2 closed drives the RMS Converter from the the quasi-sinewave (settling only);

S3 open removes V_{out} from the measurement;

S4 open freezes V_{ref} ;

S5 closed the A-D and processor measure V_{ref} .

Third Measurement (M3) :

The quasi-sinewave is measured by the RMS converter, A-D and processor.

S1 open V_{sig} is not applied;

S2 closed drives the RMS Converter from the quasi-sinewave for the measurement;

S3 closed applies V_{out} for the quasi-sinewave to the A-D and processor for measurement;

S4 open V_{ref} remains frozen;

S5 open prevents V_{ref} from interfering with the RMS measurement of the quasi-sinewave;

Final RMS Computation

If the gain of the RMS Detector, Filter and Buffer is G (not precisely known), then:

$$M1 = G.V_{sig}(RMS);$$

$$\text{so } V_{sig}(RMS) = M1 / G.$$

$M2$ and $M3$ are combined to determine G very precisely:

$$G = \text{Transfer Measurement} / \text{Transfer Reference} = M3 / M2.$$

This is used to eliminate G :

$$V_{sig}(RMS) = M1.M2 / M3.$$

Resistance

Introduction (Fig. 1.8)

This function is achieved using a set of constant current sinks and precision shunts in conjunction with the DCV measurement capability.

Switched Constant Currents

The constant current is sourced from the low-follower, but its value is determined by switched feedback elements in the current sink (current mirror). Conventional current flow is as shown in Fig. 1.8, through the unknown resistance from the I+ contact to the I- contact of the input plug.

Voltage Measurements

The unknown resistance value is obtained by measuring the voltage across the resistor terminals, then digitally dividing this voltage by the (known) constant current.

With the unknown resistor as the negative feedback path for the low follower; the potential at the resistor Lo terminal is passed, via the isolating inputs of the low follower, into the DC Voltage assembly. Here it sets the reference common for the DC Preamplifier. The voltage at the resistor Hi terminal drives the DC Preamplifier Hi input, so the DCV circuitry measures the voltage across the resistor. The DC Voltage range to be used is set by the Resistance range (and hence by the value of constant current in the unknown resistor).

Calculation of Resistance Value

The constant current for the range is known and characterized in firmware. Once the voltage has been measured via the DC Preamplifier, A-D, and digital circuits, it is divided by the stored current value and the result is presented to the Main display.

Current

Switched Precision Shunts (Fig. 1.9)

For Current measurement up to the 1A range, switched precision shunts are fitted internally. The unknown current passes through one of these, and the resulting voltage is measured. The shunts and the source of the current are protected both electronically and by a 1.6A fuse, accessible on the rear panel.

For Current measurement on the 10A range, the Datron model 4953 is required (see page 1-11 and Appendix A to this section).

For DC Current measurement the DCV circuitry measures the shunt voltage.

For AC Current measurement the DCV circuitry measures the shunt voltage.

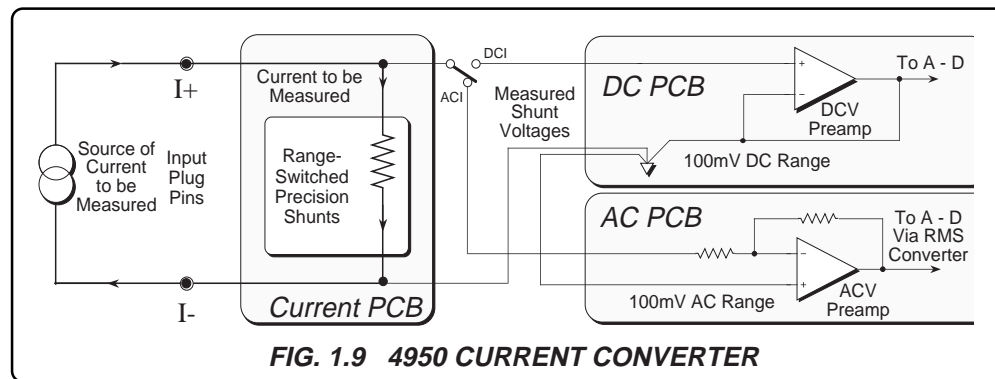
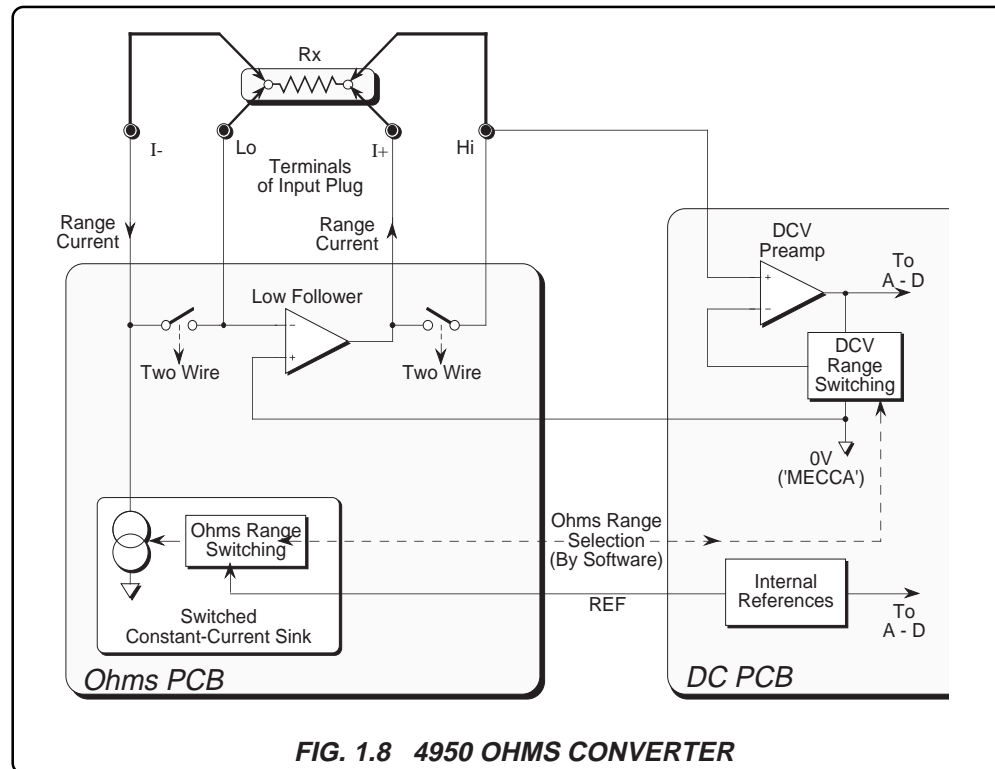

This page intentionally left blank

10A Current Shunt Model 4953

Use of the 4953

The 4950 Multifunction Transfer Standard is designed for DC and AC Current calibration applications up to 1A using internal shunts.

For DC and AC Current calibration up to 10A, the user requires the 4953 10A current shunt. Moreover, the same shunt needs to be used at all stages in the transfer loop.

Reference is made to the requirement for an identified 4953 10A shunt in the 4950 User's Handbook:

Section 1, pages 1-11 and 1-20;
Section 3 pages 3-26 to 3-38;
Section 4 pages 4-19 to 4-26;
Section 5 pages 5-34 to 5-37.

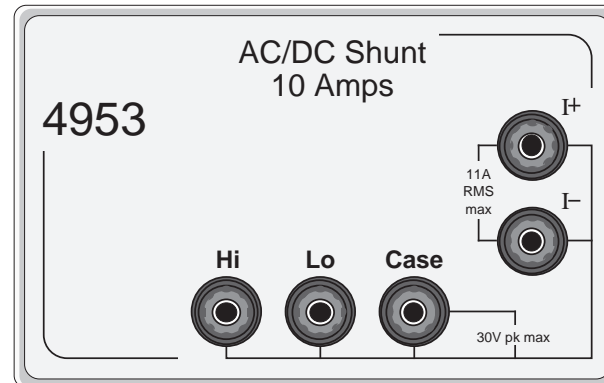

Connecting the 4953 to the 4950

The 4953 is connected as a current sensing resistor in the same way as the 4950 internal shunts, but all the connections are made externally.

The current to be measured is passed through the 4953 shunt via its I+ and I- terminals, and the sensed voltage is passed to its Hi and Lo terminals respectively. The Hi and Lo leads of the 4950 input cable connect to the corresponding 4953 terminals. For guarding purposes, the 4950 guard lead connects to the 4953 'Case' terminal.

10A Range Selection and Specification

The 10A range cannot be selected until the serial number of the 4953 has been entered in a DC Current menu. Once the 4950 is set to its DCI 10A range, the DCV 100mV range is automatically selected, taking its input from the 4950 Hi and Lo terminals. For the ACI 10A range, the ACV 100mV range is employed in the same way.

The 4953 is calibrated only via the 4950, so the specifications for the 4953 are described by the 4950 DCI and ACI 10A range specifications.

SECTION 2 Installation and Operating Controls

This section contains information and instructions for unpacking and installing the Model 4950 Multifunction Transfer Standard. It also introduces the layout of controls on the instrument.

Unpacking and Inspection

Every care is taken in the choice of packing material to ensure that your equipment will reach you in perfect condition.

If the equipment has been subject to excessive handling in transit, the fact will probably be visible as external damage to the shipping carton.

In the event of damage, the shipping container and cushioning material should be kept for the carrier's inspection.

Unpack the equipment and check for external damage to the case, sockets, keys etc. If damage is found notify the carrier and your sales representative immediately.

Standard accessories supplied with the instrument should be as described in Section 1.

Calibration Enable Switch S2

IMPORTANT

This two-position rear-panel switch protects the instrument calibration memory.

The instrument was initially calibrated at the factory, so the switch should always remain set to **DISABLE**, until immediate recalibration is intended.

For Recalibration:

If the external calibration menu is selected while the key is not in the enabling position, the menu is replaced by the warning message:

1002: calibration disabled

Introduction to the Front Panel

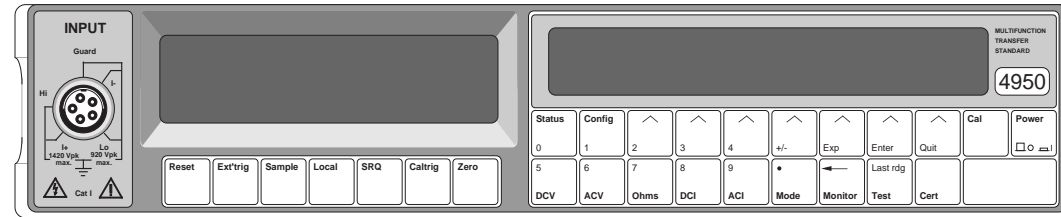

The two displays on the front panel deal with different aspects of operation. We set up the instrument's configuration using menus shown in the right-hand (dot-matrix 'menu') display, then readings appear in the left-hand ('main') display.

Beneath the dot matrix display, all keys other than the Power key are associated with menus. The keys beneath the main display are direct action keys, associated with triggers, remote control, input zeroing and instrument reset.

Menu Keys

There are two classes of front panel menu keys, those that lead to an immediate change of instrument state (i.e the major function keys DCV, ACV, Ohms, DCI, ACI), and those that do not (Status, Config, Cal, Mode, Monitor, Test, Cert).

Major Function Keys:

DCV, ACV, Ohms, DCI, ACI

Each of these function keys defines a separate measurement state and activates its corresponding menu on the dot matrix display. Changing a selection alters the measurement state.

Numeric Keyboard

Seventeen of the menu and soft function keys also act as a keyboard for entry of parameters such as math constants, bus address, etc. The data entered is purely numeric, and can consist of either a keyboard-entered value or the value of the most recent reading.

Introduction to the Rear Panel

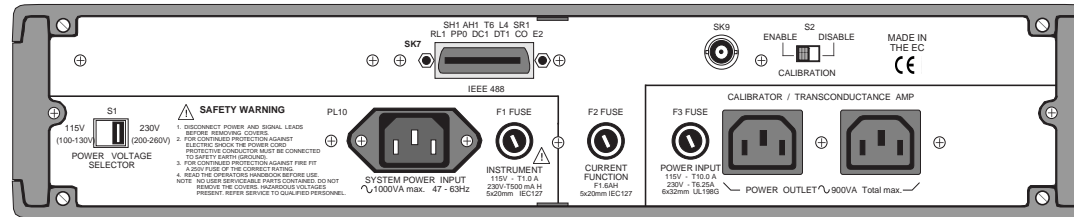

Mechanical Access

The top or bottom cover is released for removal by undoing two screws visible at the rear. A single screw retains the corner block which covers the handle mechanism on each side panel.

Labels

The rear panel displays the identification label for the instrument, and a modification label.

External Connections

Apart from the front input connector, any connections to the internal circuitry enter via the rear panel.

SK7 is the standard IEEE 488 connector. A list of interface function subsets is printed next to the connector.

SK9 is not used.

Fuses

The fuse F1, adjacent to the power input plug, protects the power input line to the 4950 instrument circuitry. The centre fuse F2 protects the current measuring circuitry. The two power outlets are protected by common fuse F3.

CAUTION SEE THE SAFETY ISSUES SECTION AT THE FRONT OF THIS MANUAL.



Voltage Selector

The recessed power line voltage selector adapts the instrument to either 115V or 230V line inputs.

CAUTION SEE THE SAFETY ISSUES SECTION AT THE FRONT OF THIS MANUAL.



Calibration Switch

To calibrate the instrument, special menus are available via the IEEE 488 remote interface or from the front panel. But to enter these menus it is necessary to set the calibration Switch on the rear panel to ENABLE.

Preparation for Operation

WARNING THIS INSTRUMENT CAN DELIVER A LETHAL ELECTRIC SHOCK. NEVER TOUCH ANY LEAD OR TERMINAL UNLESS YOU ARE ABSOLUTELY CERTAIN THAT NO DANGEROUS VOLTAGE IS PRESENT.



WHEN MAKING 2-WIRE MEASUREMENTS WITH A 4-WIRE LEAD SET, ALWAYS INSERT THE UNUSED I+ (BROWN) AND I- (BLUE) LEADS IN THE SUPPLIED DUAL BANANA ADAPTOR (PART NO. 630416). ALWAYS ENSURE THAT YOUR LEADS ARE IN A SAFE CONDITION BEFORE USE.



NOTE: E-M INTERFERENCE

Electro-magnetic radiation from local sources, such as poorly-screened computer monitors and high alternating current generators, can affect the performance of the 4950. Refer to *Page 2-7* before arranging the bench or rack layout.

Line Input Voltage Selector

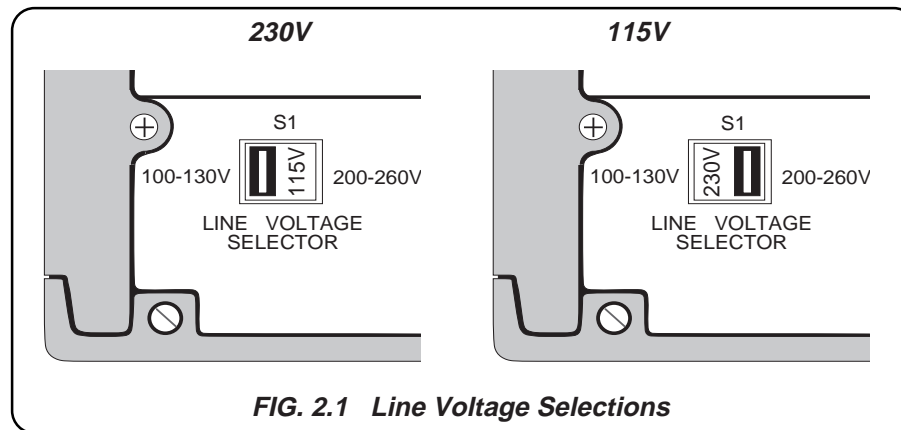

FIG. 2.1 Line Voltage Selections

CAUTION BEFORE CONNECTING TO THE LINE SUPPLY, ENSURE THAT THE VOLTAGE SELECTOR AND LINE FUSES ARE CORRECT FOR THE LOCAL SUPPLY.

115V Line Supply Selection

For 100V to 130V supplies, the legend '115' must be visible in the window of the line voltage selector switch (S1) on the rear panel.

230V Line Supply Selection

For 200V to 260V supplies, the legend '230' must be visible in the window of the line voltage selector switch (S1) on the rear panel.

Line Power Distribution and Fuse Location

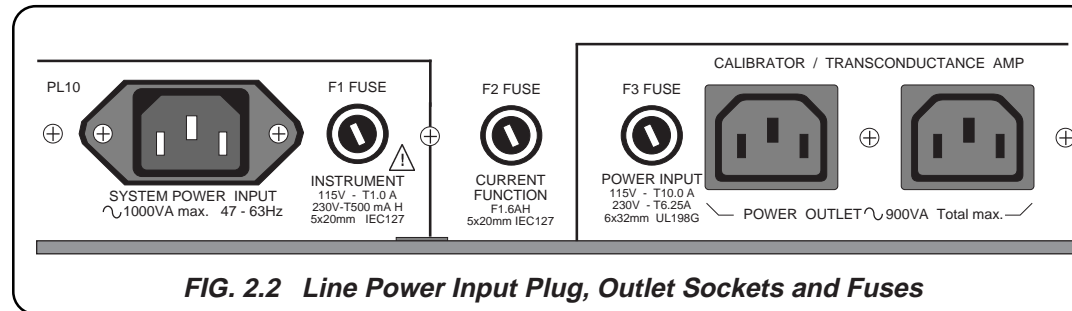

System Line Power Input

The correct local version of the line supply cable should have been shipped in the cable compartment of the Transit Case. It comprises two metres of 3-core PVC sheath cable moulded to a fully-shrouded 3-pin socket at the 4950 end, with the local 3-pin plug on the other. It fits into a plug (PL10) at the rear of the instrument.

The supply end of the cable **must** be connected to a grounded outlet, ensuring that the Protective Earth (Ground) lead is connected.

Instrument Line Power Fuse F1

The line input is passed through Fuse F1 and filter before being applied to the instrument circuits. The power fuse F1 is situated next to the power input plug on the rear panel.

Current Function Fuse F2:

The centre fuse is *not* a line power fuse. F2 is a quick-acting fuse, protecting the Current Function signal input.

System Line Power Outlets and Fuse F3

Two line outlet sockets are provided on the rear of the Model 4950. One outlet is intended to supply power to a 470x or 480x series Calibrator, and the other to power the Model 4600 Transconductance Amplifier.

These outlets are provided with a separately filtered supply derived from the main line-input plug.

NOTE: IF THE SYSTEM IS NOT CONFIGURED IN THIS WAY, RESULTS MAY BE AFFECTED BY LINE VOLTAGE NOISE ERRORS.

The power fuse F3 protects both outlets. It is situated to the left of the two power outlets on the rear panel.

CAUTION ENSURE THE CORRECT FUSES ARE FITTED IN ALL FUSE POSITIONS BEFORE USE. SEE THE SAFETY ISSUES SECTION AT THE FRONT OF THIS MANUAL.



Line Power Distribution (Contd.)

Automatic 50-60Hz Operation

The 4950 is capable of operation at any line frequency from 47Hz to 63Hz, so no means of line frequency selection is necessary.

Options 80 and 81 - Factory Selection of Line Voltage and Frequency

If **neither** Option 80 nor 81 was specified at the time of ordering, the instrument will be configured for operation at **230V 50Hz**. It will be calibrated and shipped in this configuration.

If **Option 80** was specified at the time of ordering, the instrument will be calibrated and shipped in **115V 60Hz** configuration.

If **Option 81** was specified at the time of ordering, the instrument will be calibrated and shipped in **115V 50Hz** configuration.

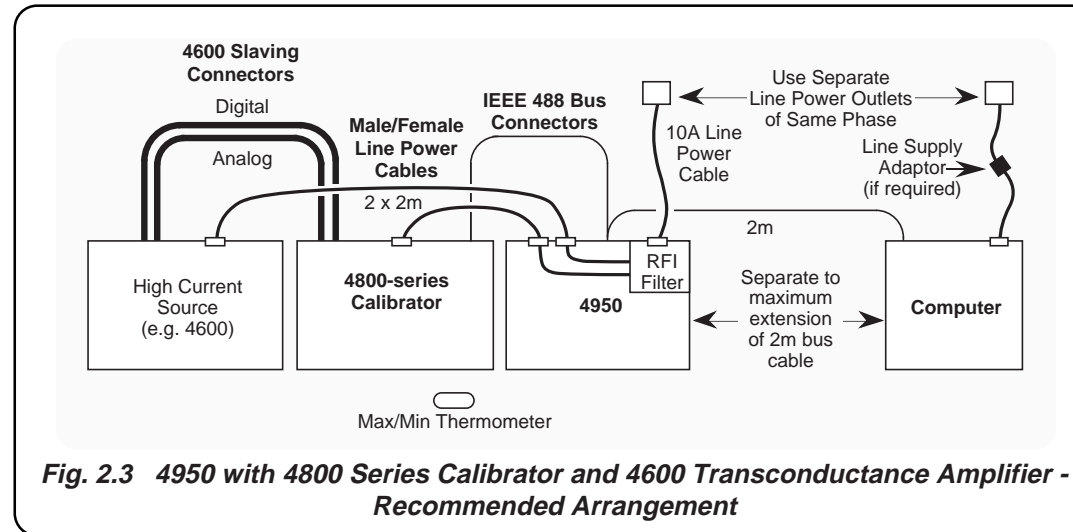

Fig. 2.3 4950 with 4800 Series Calibrator and 4600 Transconductance Amplifier - Recommended Arrangement

Positioning of the 4950 to Avoid E-M Interference

Sources of Error

Interference from Computers

Problems can be caused by interference from computer monitors. E-M radiations from EHT supplies can introduce noise at an unacceptable level, particularly when the computer's line power cables run close to the 4950 line supplies.

Proximity Interference

Radiated interference can occur when other equipment is too close to the 4950, particularly from high alternating-current sources.

Avoidance

Separate the Power Supplies

Plug in any computer at a power outlet remote from that used for the 4950 (but where 3-phase supplies are present, use an outlet on the same phase of the line supply as the 4950).

Do not mount *any* other equipment on top of the 4950

Do not mount the 4950 *directly* on top of other equipment

Maintain a vertical separation of at least 300mm. This is particularly important when mounting the 4950 in a rack.

Placement of System Units

The placement of instruments involved in calibration operations should conform as closely as possible to the arrangements shown in *Figs. 2.3* and *2.4*.

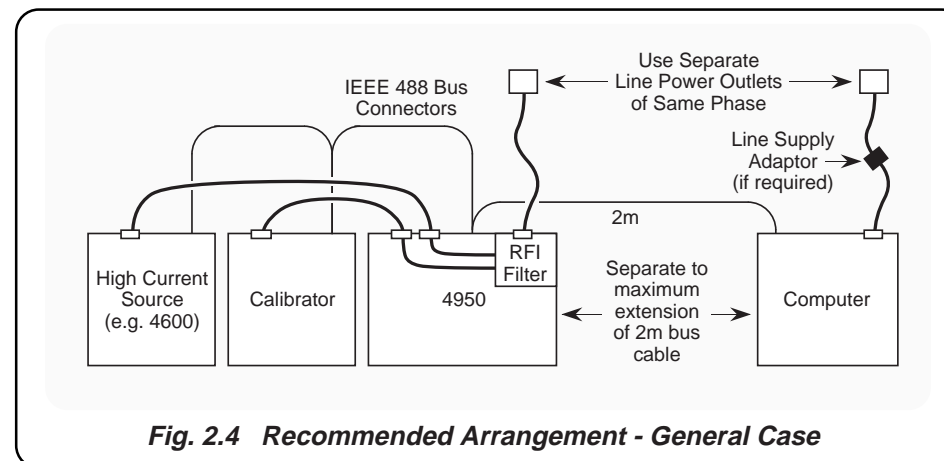

Fig. 2.4 Recommended Arrangement - General Case

Mounting

NOTE: E-M INTERFERENCE

Electro-magnetic radiation from local sources, such as poorly-screened computer monitors and high alternating current generators, can affect the performance of the 4950. Refer to *Page 2-7* before arranging the bench or rack layout.

Bench Use:

The instrument is fitted with rubber-soled plastic feet and tilt stand. It can be placed flat on a shelf or tilted upwards for ease of viewing.

Rack Mounting - Option 90:

Option 90 permits the instrument to be mounted in a standard 19 inch rack. The method of fitting this option is described below, the locations being shown in the diagram opposite.

N.B. The top or bottom cover should not be removed for this purpose.

Procedure

1. Remove each of the two rear corner blocks by undoing its single crosspoint screw, and store safely for possible future use.
2. Invert the instrument, and remove each handle as follows:
 - a. Pull out the handle until the two 1.5mm socket-headed screws are visible in the handle locking bar.
 - b. Loosen the two locking screws using the 1.5mm hex key provided. Leave the screws in the bar.
 - c. Slide the whole handle assembly to the rear, out of the side extrusion.
3. Fit each front rack mounting ear as follows:
 - a. With its bracket to the front, slide the ear into the side extrusion from the rear.
 - b. Loosely fasten the ear to the extrusion at the front, using the four socket grubscrews provided.
4. Assemble the front plate and handle to the front ear as shown in the diagram, and clamp them together using the two countersunk screws provided.
5. Tighten all six screws.
4. Remove the feet and tilt stand as follows:
 - a. Prize off the rubber pads from the four feet.
 - b. Undo the two securing screws from each foot. This releases the feet, washers and tilt stand so that they can be detached and stored safely for possible future use.
5. Fit the instrument to the rack as follows:
 - a. Attach the two rear ears to the back of the rack, ready to receive the instrument.
 - b. With assistance, slide the instrument into the rack, locating the rear ears in the side extrusions. Push the instrument home, and using screws, cage nuts etc. provided with the rack, secure the instrument by screwing the front ears to the front of the rack.

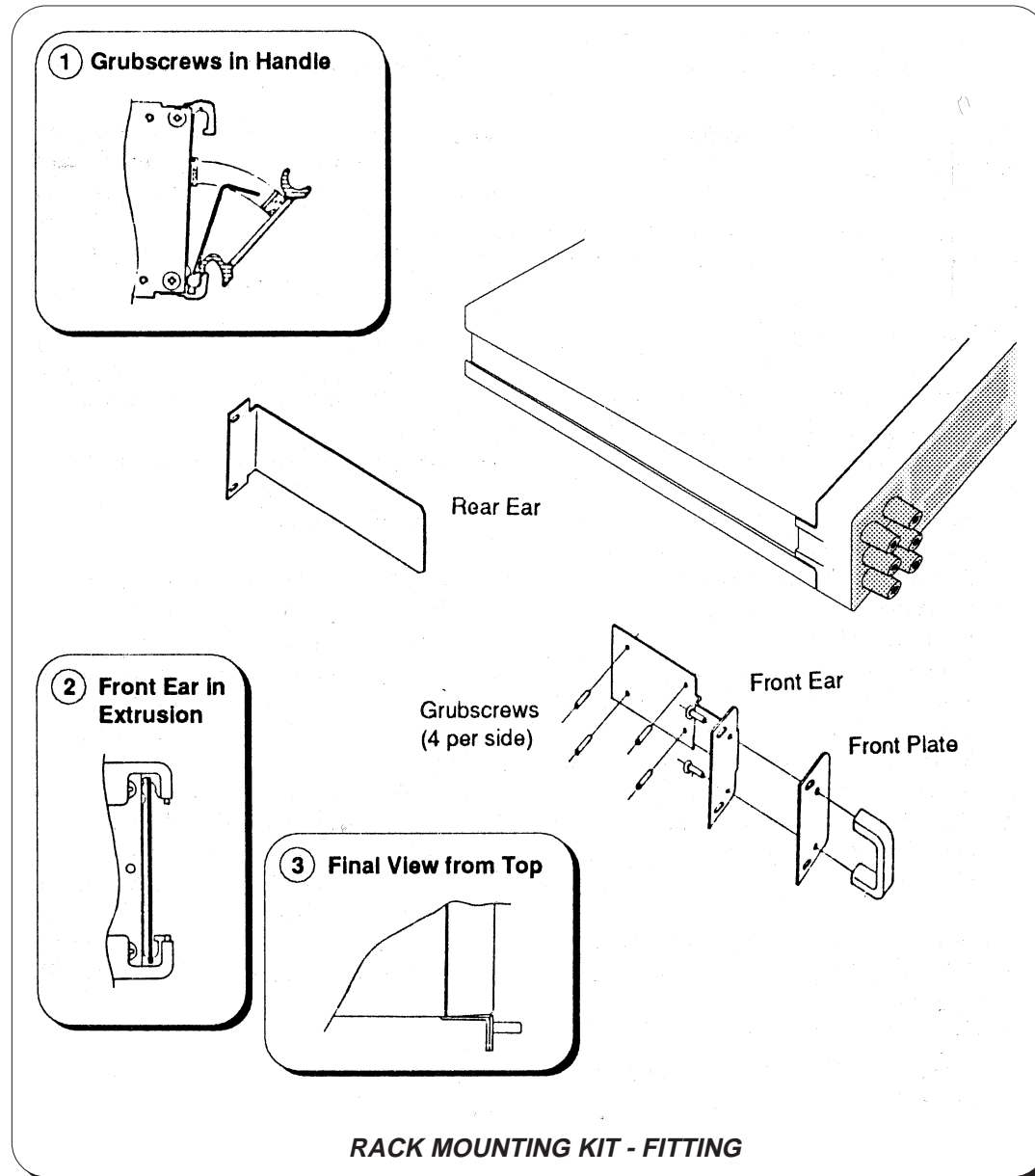

Mounting (Contd.)

NOTE: E-M INTERFERENCE

Electro-magnetic radiation from local sources, such as poorly-screened computer monitors and high alternating current generators, can affect the performance of the 4950. Refer to *Page 2-7* before arranging the rack layout.

Rack Slide Kit - Option 95:

Option 95 permits the 4950 to be mounted on slides in a standard 19 inch rack. The instrument can be pulled forward into a position where its rear panel is clear of the rack, to give access to the rear connectors. Cables should not be connected to the instrument until it is mechanically secure in the slides. The method of fitting this option is described below, the locations being shown in the diagram on *page 2-13*.

N.B. Neither top nor bottom cover should be removed for this purpose.

Procedure

1. Remove each of the two rear corner blocks by undoing its single crosspoint screw, and store safely for possible future use.
2. Invert the instrument, and remove each handle as follows:
 - a. Pull out the handle until the two 1.5mm socket-headed screws are visible in the handle locking bar.
 - b. Loosen the two locking screws using the 1.5mm hex key provided. Leave the screws in the bar.
 - c. Slide the whole handle assembly to the rear, out of the side extrusion.
3. Fit each slide mounting bracket (Pt. No. 450659) as follows:
 - a. With its ear to the front, slide the bracket into the side extrusion from the rear.
 - b. Locate and loosely fasten the bracket to the extrusion, using the six socket grubscrews provided.
4. Remove the inner section of each slide (Pt. No. 630353) from the other two sections as follows:
 - a. Lay the slide flat with its inner section uppermost. A rubber grip secures the inner section to the outer section at the rear.
 - b. Slide the inner section forward to disengage the rubber grip, then slide fully forward against the release latch.
 - c. When fully extended, invert the slide so that the release latch is visible.
 - d. Press the bevelled side of the release latch, while drawing the inner section out of the middle section.
5. Fit the inner section of each slide to its mounting bracket (Pt. No. 450659) as follows:
 - a. Assemble the slide to the bracket as shown in the diagram (note the position of the release latch), and clamp them together using the three countersunk screws provided.
 - b. Tighten the six grubscrews and the three countersunk screws.
 - c. Fit and secure the front plate and handle to the slider ear, using the two M4 x 12 countersunk screws provided.

6. Remove the feet and tilt stand as follows:
 - a. Prize off the rubber pads from the four feet.
 - b. Undo the two securing screws from each foot. This releases the feet, washers and tilt stand so that they can be detached and stored safely for possible future use.
7. Fit each 10 inch mounting bracket to the correct position on the rack as follows:
 - a. Offer the bracket to the front of the rack as shown in the diagram. Secure the bracket through the rack slots using two slotpan screws, two shakeproof washers, two plain washers and a 2.5 inch nut bar. Slacken the screws slightly to ease final positioning when the instrument is pushed home.
8. Fit each 2 inch mounting bracket to the correct position on the rack as follows:
 - a. Offer the bracket to the rear of the rack as shown in the diagram. Secure the bracket using two slotpan screws, two shakeproof washers, two plain washers and a 2.5 inch nut bar. Slacken the screws slightly to ease final positioning when the instrument is pushed home.
9. The outer section of the slide has two securing holes at the front and two slots at the rear, each within cut-out tongues. The slides are fixed to the adjustment slots in the 10 inch and 2 inch mounting brackets by two slotpan screws through the front holes, and one through one of the rear slots. (The rack depth determines which slide slot is to be used. If the rack is too shallow, the 2 inch bracket can be reversed so that it protrudes rearwards from the rack.)
 - a. Gain access to the rear slots by sliding the middle section and bearing carriage to the front. The two front holes can be accessed by sliding the middle section and bearing carriage to expose each hole in turn through a rectangular cutout in the middle section.
10. Fit each slide to the correct position on the rack as follows:
 - a. Offer the slide outer and middle sections to the 10 inch and 2 inch mounting brackets as shown in the diagram. Secure the slide to the brackets using the three slotpan screws, three shakeproof washers, three plain washers and three M4 nuts provided.
11. When sliding the instrument into the rack for the first time, the slotpan screws securing the 10 inch and 2 inch mountings should have been slackened. This ensures that there is no lateral stress on the mounting system during the operation. These screws are finally tightened with the instrument sitting in the slides.
 - a. Ensure that the screws securing the 10 inch and 2 inch mountings have been slackened.
 - b. With assistance, locate the slide inner section in the bearing carriage of the middle section, and carefully slide the instrument fully home into the rack. Slide it in and out of the rack several times until it is certain that there is no lateral stress.
 - c. Withdraw the instrument just sufficiently to allow access to the slotpan screws securing the 10 inch and 2 inch mountings. Tighten the screws, and again slide the instrument in and out of the rack to be certain that there is no lateral stress.
12. Using screws, cage nuts etc. provided with the rack, secure the instrument by screwing the mounting bracket ears to the front of the rack.

Mounting (Contd.)

Rack Slide Kit - Option 95 - List of Parts:

Rack mounting, especially using slides, is complicated by the diversity of rack fittings within the standard 19" concept. Although the Rack Slide Kit contains all the parts necessary to fit the instrument, on its slides, to a standard 19" rack; the assembly would normally be finally secured in position using attachments peculiar to the type and manufacturer of the rack. These final securing parts are not listed below.

The following list of parts is correct at the time of going to press, but our policy of product improvement means that alternative items could be employed for future issues. The current updated parts list is given in the Reference Handbook for the instrument.

Part No.	Description	UM	Quantity
450655-1	Rack Ear, Handle	Ea	2
450659-1	Bracket, Slide Mounting	Ea	2
450680-3	Rack Mounting, Front Plate	Ea	2
611028	Screw, M4 x 8 POSIPAN SZP	Ea	6
611058	Screw, M4 x 8 POSICSK SZP	Ea	6
611059	Screw, M4 x 12 POSICSK SZP	Ea	4
611071	Screw, 10-32 x 1/2 SLOTPAN SZP	Ea	8
611116	Screw, M3 x 12 SKT GRUB SZP	Ea	12
613013	Washer, M5 SZP	Ea	8
613020	Washer, M4 SZP	Ea	6
613021	Washer, M4 INT. SHAKP	Ea	6
613028	Washer, M5 INT. SHAKP	Ea	8
615011	Nut, Full, M4 SZP	Ea	6
630181	Bracket, 2", Mounting	Ea	2
630182	Bracket, 10", Mounting	Ea	2
630183	Nut, 2.5" Bar	Ea	4
630353-1	Slide, 24", 3-Section, Pair	Ea	1

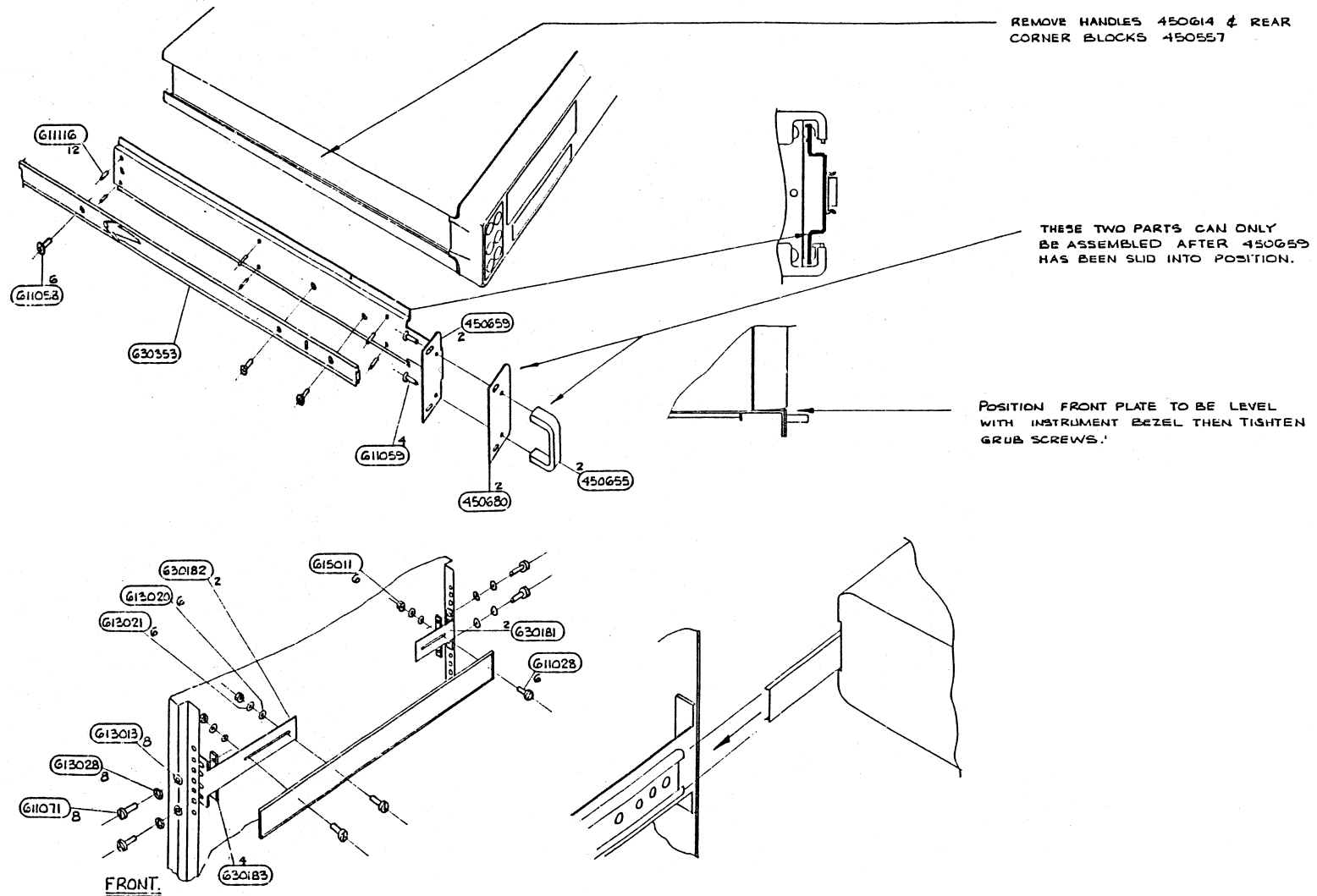

RACK SLIDE KIT - FITTING

Connectors and Pin Designations

Signal Input

5-pole Fixed Plug

All signals are input via the 5-pole fixed plug on the front panel, whose input connections and orientation are as follows:

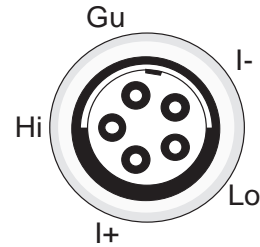

Fixed Plug

Input Cable Assembly

An input cable assembly is provided with the instrument that consists of a five pole free socket, with leads that terminate in colour-coded banana plugs. The leads are clearly identified by colour and sleeve labels. The lead connections and socket orientation are as follows, viewing from the open end of the socket:

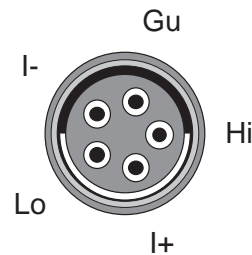

Free Socket

Calibration Integrity!

The input cable assembly is an integral part of the 4950, and they are calibrated together. Unless the same cable/instrument combination is employed when in use, traceability is lost.

It is therefore **essential** that the instrument and its cable remain together, and are used together. If for any reason (such as damage) it is necessary to replace a cable assembly, the 4950 must be recalibrated with its new input cable assembly before any subsequent measurements are made.

During calibration, the input cables are characterized in 4950 non-volatile memory for Ohms operation. It is not possible to select this function until the serial number of the calibrated cable assembly (lead) has been entered via the front panel or over the remote interface.

For further details refer to *Section 4, Page 4-5*, and *Section 5, Page 5-54*.

Lead Identification

	Sleeve and Plug Colour	Cable Marker
Input cable	Red	Hi
	Black	Lo
	Brown	I +
	Blue	I -
	White	Guard

SK7 - IEEE 488 Input/Output

Compatibility

The IEEE input/output is a 24-way Amphenol connector which is directly compatible with the IEEE 488 interface and the IEC 625 Bus.

Note that the Bus Address is set from the front panel (refer to *Section 5, Page 5-4*).

Pin Layout

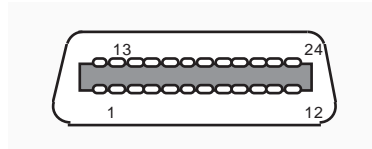

SK7 Pin Designations

Pin No.	Name	Description
1	DIO 1	Data Input/Output Line 1
2	DIO 2	Data Input/Output Line 2
3	DIO 3	Data Input/Output Line 3
4	DIO 4	Data Input/Output Line 4
5	EOI	End or Identify
6	DAV	Data Valid
7	NRFD	Not Ready For Data
8	NDAC	Not Data Accepted
9	IFC	Interface Clear
10	SRQ	Service Request
11	ATN	Attention
12	SHIELD	Cable Screening (connected to 4950 safety ground)
13	DIO 5	Data Input/Output Line 5
14	DIO 6	Data Input/Output Line 6
15	DIO 7	Data Input/Output Line 7
16	DIO 8	Data Input/Output Line 8
17	REN	Remote Enable
18	GND 6	Gnd wire of DAV twisted pair
19	GND 7	Gnd wire of NRFD twisted pair
20	GND 8	Gnd wire of NDAC twisted pair
21	GND 9	Gnd wire of IFC twisted pair
22	GND 10	Gnd wire of SRQ twisted pair
23	GND 11	Gnd wire of ATN twisted pair
24	GND	4950 Logic Ground (internally connected to Safety Ground)

SECTION 3 Basic Measurements

This section introduces the basic ‘User Interface’ of the 4950, describing how to make measurements without recourse to the more advanced features of the instrument. These other features are described in Section 4.

The Measurement Task

With the external circuit properly connected, any measurement requires us to take two actions:

1. Configure the instrument;
2. Trigger the measurement and read the result.

The 4950 allows us to choose from many actions to control these processes. As an introduction, we shall concentrate on the selections for taking basic measurements of AC and DC Voltage, AC and DC Current; and Resistance. These are not complicated - all we need to do is to work through the instrument’s selection menus.

Introduction to the Front Panel

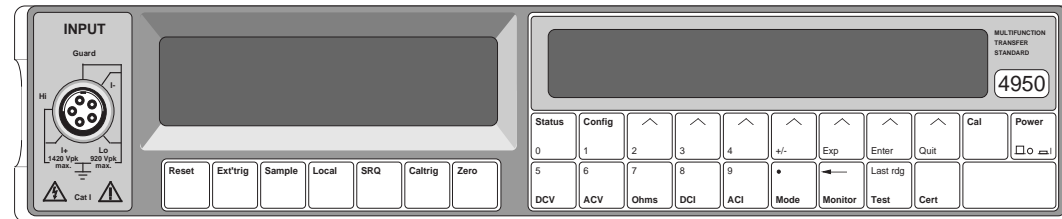

The two displays on the front panel deal with different aspects of operation. We set up the instrument’s configuration using menus shown in the right-hand (dot-matrix) display, then readings appear in the left-hand (main) seven-segment display.

Beneath the dot matrix display, all keys other than the Power key are associated with menus. The keys beneath the main display are direct action keys, associated with triggers, remote control, and instrument reset.

Menu Keys

Power-On State

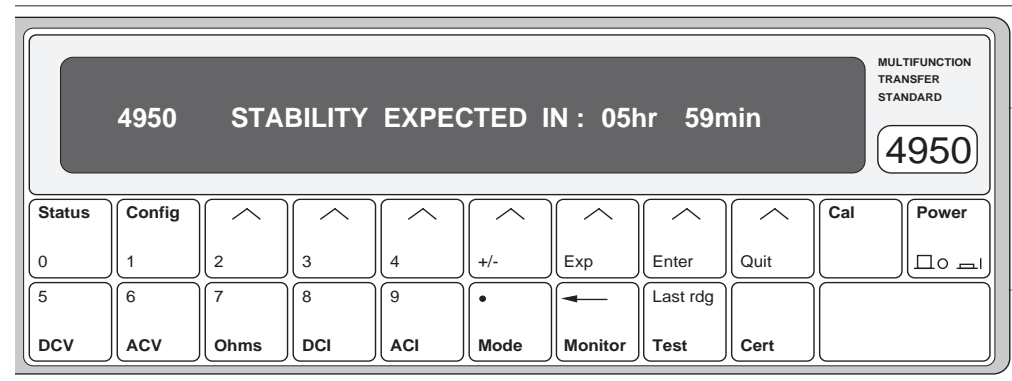

There are two classes of front panel menu keys; those that lead to an immediate change of instrument state (i.e the major function keys DCV, ACV, Ohms, DCI, ACI), and those that do not (Status, Config, Cal, Mode, Monitor, Test, Cert).

As well as the menu selection keys, there are seven soft function selection keys which have different actions depending on the selected menu. An arrowhead printed on each soft key lines up with a label which defines the action of the key.

Also, system messages may appear (all in capitals such as the power-on 'standby' state message shown above), these assist in clarifying operation.

The labelled soft keys have actions which fall into the following classes:

- Select another menu.
- Enable or disable a facility (e.g. 2 or 4-wire in Ohms). When enabled, the soft key label is underlined by a cursor.
- Trigger a direct action (e.g. 'Conf' in the TEST menu activates a confidence selftest).

An error message appears if a selection cannot be executed (e.g. 1008 Must be in AC function).

Numeric Keyboard

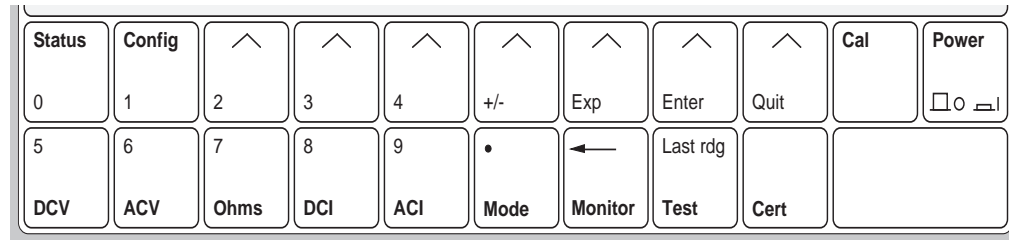

Some menu and soft function keys, shown above, also act as a keyboard for entry of parameters such as the serial number of the 2-wire ohms lead, non-nominal target values for calibration, bus address, etc. The data entered is purely numeric, and can consist of either a keyboard-entered value or the value of the most recent reading.

Exit from Menus

We can generally exit from any menu by selecting another menu key. For those menus where the keyboard is active, we can exit by pressing either Enter or Quit. For some menus, a special soft key permits exit by a single keystroke.

Major Function Keys: DCV, ACV, Ohms, DCI, ACI.

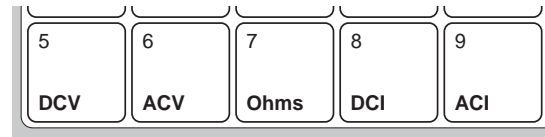

Each of these function keys defines a separate measurement state and activates its corresponding menu on the display. Changing a selection commands a change of measurement state. Each function has its associated CONFIG (Configuration) menu, which we can use to set up 'function-dependent' parameters, such as local/remote guard and 2/4-wire Ohms connections.

Instrument Role as a Calibrator of Calibrators

Although the 4950 shares the general appearance of a high-precision digital multimeter, its role is highly specialized as a Multifunction Transfer Standard.

For example, the measurement range for each of the 4950's functions does not cover the full range span. Instead, ranges are constrained to one or more discrete bands of values that suit the calibration points of common multifunction calibrators.

Saved Selections

Generally, selections such as Range, Guard etc., which are made within a major function are saved when exiting the function, and restored when the function is next selected.

Measurement Band and Frequency Band selections (these are peculiar to individual ranges) are made within the range menus. During range changes, the selected band is saved, then restored when the range is next selected. Each band selection remains tied to its function/range combination, even when the function is inactive, then restored when the function and range are reselected.

Any deviation from the above rules will be noted within the appropriate description (e.g ACV HF 2-wire/4-wire defaults to 4-wire on change of frequency band or range).

Initial State at Power On

When the 4950 is first switched on, the 'menu' (dot-matrix) display reminds us to wait until the internal temperature has stabilized (six hours from power-on), before using the instrument as a transfer standard.



4950 STABILITY EXPECTED IN : 05hr 59min

The display counts the warm-up period down from six hours to zero. If by this time no front panel selection has been made, then the display will change to show 'Status' information (as described later on *pages 3-39 to 3-44*) and the 4950 is ready for use.

During warm-up, the count-down display can be seen by pressing the front panel **Status** key. After warm-up is complete, using this key presents regular status information.

Power Down - Short Term

If power is temporarily removed, the amount of unused warm-up period is memorized. The clock continues to run, driven by an internal battery. When power is restored, a new warm-up period is calculated and imposed, also accounting for the 'down' time as follows:

$$T = 6 (t - t_s) + t_w$$

Where:

- t_s = Real time when power is removed
- t_w = Warm-up period remaining when power is removed
- t = Real time when power is restored
- T = Calculated new warm-up period

After calculation, the following limits are applied to T:

- minimum:* 10 minutes
- maximum:* 5 hours 59 minutes

Internal States at Power On

All the functions and facilities are configured into default states when power is turned on. These are shown in the following table.

	DCV	ACV	Ohms	DCI	ACI
Range	1kV	1kV	100k Ω	1A	1A
Frequency Band	---	1kHz	---	---	300Hz
Measurement Band	0%	100%	0%	0%	100%

The active function is **DCV**, so the Main (left-hand) display is set up to read DC Voltage. The display is blank except for the **Ext** annunciator (external trigger selected, so no triggers yet). The active power-on defaults are:

Function: DCV. Range: 1kV. Measurement Band: 0%

Global power-on and reset defaults:

*Guard: Local. Trigger Source: External.
Accuracy Mode: High. Calibration: Disabled.
Corrections: Certified.*

Specific power-on and reset defaults:

*2/4-wire Ohms 4-Wire
2-Wire Ohms Undefined, but the serial number of the lead which
Lead Serial No. was characterized at the most-recent calibration is
held in non-volatile RAM.
10A Shunt Serial No. Undefined, but the serial number of the shunt which
was characterized at the most-recent calibration is
held in non-volatile RAM.*

Operation During Warm-Up

Although it is necessary to wait for the warm-up period to elapse before using the 4950 to perform in its designed role, it is nevertheless possible to operate the instrument to explore the way that the menus are arranged. Indeed in view of the itinerant nature of its role, this period provides an ideal opportunity for familiarization. So long as the instrument power remains switched on, the warm-up period will not be interrupted and the 4950 will proceed towards operational stability.

Initially, the right-hand (Menu) dot-matrix display will show a 'Status' presentation, showing the time when the instrument will achieve operational stability. To explore the DCV menus, merely press the front panel **DCV** key.

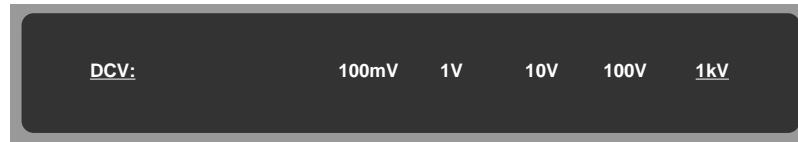

Observe the **DCV Menu**:

The 1kV range is underlined, showing the active selection (meanwhile the Main display is blanked, except for the 'Ext' annunciator, which is lit). Each range is represented on the display. The required range can be selected by pressing the soft key beneath its label; then the display will transfer to the selected range menu.

Press the **1V** range menu key, and the following menu is presented:

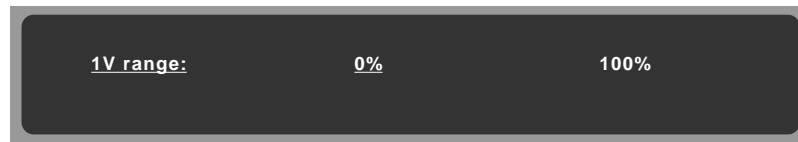

Note that the 0% band label is underlined, showing that the default band is selected. Pressing the 'Sample' key under the Main display will trigger a reading, which if the input is within the 0% band limits will generate a reading on the Main display.

Soft Key Conventions

Now look at the soft keys (the ones with the arrowheads) to make some distinctions in a little more detail. Each soft key's action is defined by the legend presented above it on the display. The legends usually define three different types of soft key:

- Choice* key Chooses one of several possible states. Deselection is by cross-cancelling, i.e. by selecting another state.
(The bands on the 1V DCV range menu are *Choice* keys).
cursor underline indicates 'active',
no cursor indicates 'not active'.
- Toggle* key Activates a particular facility - a second press when its state is active will cancel it.
(‘RemGu’ on the DCV CONFIG menu is a *Toggle* key).
cursor underline indicates 'active',
no cursor indicates 'not active'.
- Menu* key Activates another menu. The whole aim of branching via a menu is to gain access to further grouped state keys at an end of the branch.
(‘1V’ on the DCV menu is a *Menu* key).

N.B. When introducing soft keys in this section we shall differentiate between the three types (to avoid lengthy paragraphs) as follows:

<i>Choice</i> key	Underlined	e.g. <u>100mV</u>
<i>Toggle</i> key	Underlined italic	e.g. <u><i>Filt</i></u>
<i>Menu</i> key	Not underlined	e.g. Resl

Note that this is purely a short method of identifying the type, and bears no relation to its physical appearance on the instrument.

Tour of the Major Function Menus

The following introduction takes the form of a tour of the main functions, starting from Power On. To relate the descriptions to the physical appearance, process through the sequence as indicated by the pointer 

DCV Menu (See the figure on page 3-7)

This menu defines the ranges using the following *choice* keys. When returning to the DCV menu by pressing the front panel **DCV** key, the selected range is underlined by a cursor. Earlier in this sequence the 1V range was selected:

100mV 1V 10V 100V 1kV

DCV Configuration

(Remote Guard)

 Press the Config key to see the DCV CONFIG menu:



RemGu: Selects Remote Guard. When Remote Guard *is not* selected, the input-socket Guard pin is open-circuited, and the internal guards connect to internal Lo. When Remote Guard *is* selected, the Lo connection is broken, and the internal guards connect only to the input-socket Guard pin, for connection to a common-mode point in the external circuit.

Return to the DCV Menu

 Press the DCV key to return to the DCV menu.

DCV Menu

Notice that the 1V range is underlined, showing it is still selected:

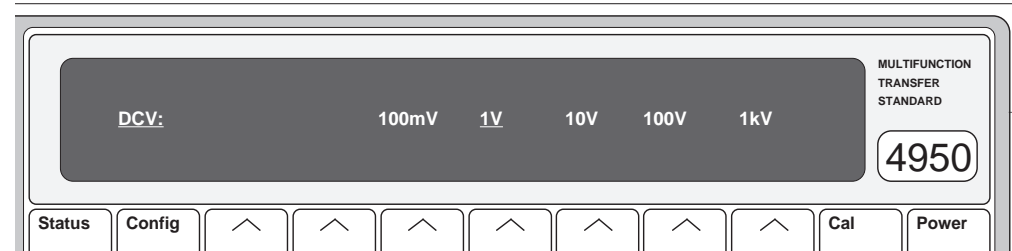

Press the 10V key to see the 10V range menu.

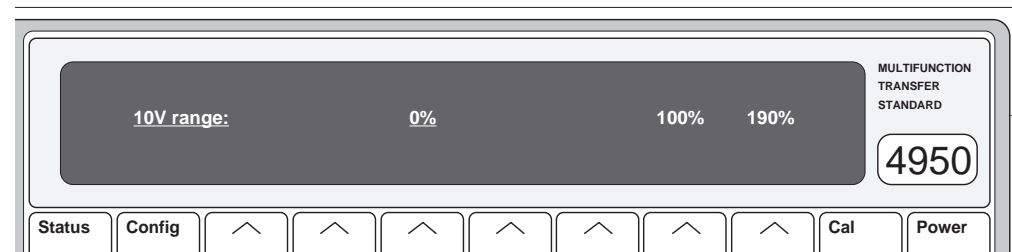

This menu defines three *choice* keys:

- 0% Selects the zero measurement band (-1V to +1V).
The 0% (zero) band is present on all DCV ranges. The band extends from -10% to +10% of nominal range value ($\pm 15\%$ on 100mV range).
- 100% Selects the full range band (-11V to -9V and +9V to +11V).
The 100% (full range) band is really two bands of opposite polarities. They are present on all DCV ranges, extending from +90% to +110% and from -90% to -110% of nominal full range value.
- 190% Selects the high band (+18V to +19.5V and -18V to -19.5V).
Again the 190% (high) band is really two bands of opposite polarities, extending from 90% to 105% of the nominal $\pm 19V$. Note that 190% is not available on other ranges - it is intended for 10V range linearity verifications only.

DC Voltage - Movement between Menus

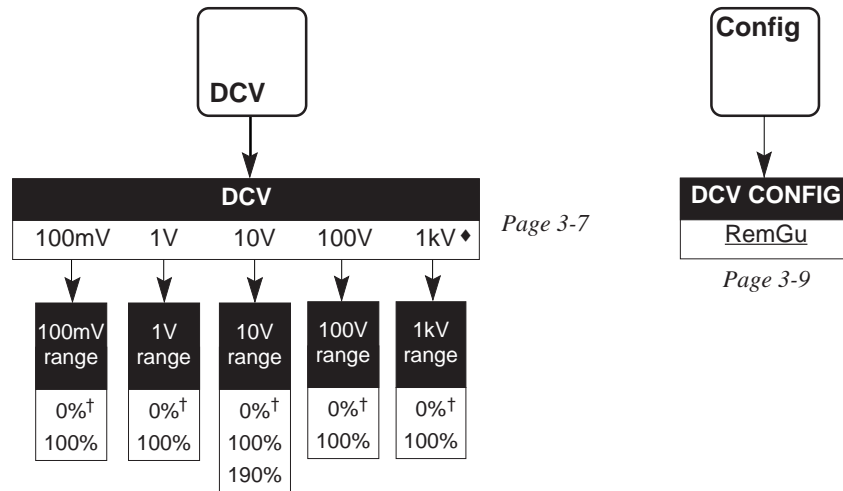

Notes:

The actions of **ACV** and **Config** hard keys are available from all the above menus.

◆ **1kV** range is the DCV power-on and reset default for all ranges.

† **0%** measurement band is the DCV power-on and reset default for all ranges.

AC Voltage



Press the ACV key to see the ACV menu:

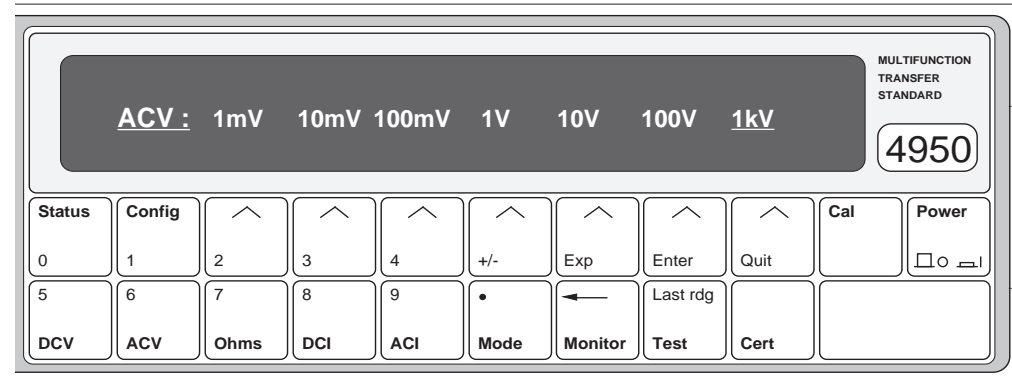

This menu defines the range *menu* keys as shown above, defaulted to the 1kV range.

Frequency

Because ACV is defined in frequency as well as voltage value, an extra layer of menus is needed for selection.

Frequency Bands

Here again the difference between the 4950 Multifunction Transfer Standard and a DMM is in evidence. As the 4950 is intended to calibrate calibrators, in this case AC Voltage sources, measurement of a continuous range of frequencies is unnecessary. Confining the response of the instrument to a series of frequency bands, operable within $\pm 10\%$ of a nominal center frequency, targets a large number of calibration points used by AC voltage calibrators. Moreover, although each frequency band has its own correction, the frequency response errors due to maintaining a wideband spectrum are drastically reduced. This allows closer tolerances to be placed on the voltage values in each band, improving the overall accuracy.

Frequency Band Selection

Most frequency bands are available on every AC Voltage range, but not all. The table shows the allocation of frequency bands to ranges; only the starred range/frequency-band combinations are available.

Available Range/Frequency-Band Combinations

Range	Frequency Band (Hz)															
	10	20	30	40	55 [‡]	300 [‡]	1k [†]	10k	20k	30k	50k	100k	200k	300k	500k	1M
1mV*	*	*	*	*	*→	←*	*	*	*→	←*	*	*		*→	←*	*
10mV*	*	*	*	*	*→	←*	*	*	*→	←*	*	*		*→	←*	*
100mV*	*	*	*	*	*→	←*	*	*	*→	←*	*	*		*→	←*	*
1V	*	*	*	*	*→	←*	*	*	*→	←*	*	*		*→	←*	*
10V	*	*	*	*	*→	←*	**	*	*→	←*	*	*		*→	←*	*
100V	*	*	*	*	*→	←*	*	*	*→	←*	*	*	*			
1kV	*	*	*	*	*→	←*	*	*	*→	←*	◆	◆				

Notes:

- † The 1kHz frequency band is the ACV default for all ranges.
- ‡ The 55Hz frequency band is extended to cover both 50Hz and 60Hz.
The 300Hz frequency band is extended to cover 400Hz.
- * For the millivolt ranges, all frequency bands: voltage measurement bands are ±15%, not ±10%.
- ◆ For the 1kV range, 50kHz and 100kHz frequency bands; voltage measurement bands are 700V, not 1kV.
- ** 10V range; 1kHz frequency band has extra voltage measurement band.
- Menu soft key provided to transfer up to next higher frequency band menu.
- ← Menu soft key provided to transfer down to next lower frequency band menu.

Frequency Band Groups

In the above table, frequency bands are grouped according to the menus in which they appear. Transfer from one menu to a higher or lower frequency menu is accomplished using special end soft-keys labelled with a right or left arrow respectively.

The 55Hz frequency band extends from 40Hz to 70Hz to permit measurement at and around the standard line power frequencies of 50Hz and 60Hz. Similarly the 300Hz band extends from 270Hz to 440Hz to measure 400Hz line power voltages.

Voltage Measurement Bands

Normal operation is restricted to a single voltage measurement band at Nominal Full Range, ±10%. Exceptions are the 1mV, 10mV & 100mV ranges, where the 100% band extends to ±15%; the 1kV range, 50kHz and 100kHz frequency bands, where the measurement band is centered on 700V; and the 10V range (*see next para*).

For many ACV calibrators, linearity on all ranges is verified by measuring a second point on a single range (usually at 19V on the 10V range, as in Wavetek calibrators). For this reason, the 10V range, 1kHz band on the 4950 has an extra measurement band at 19V (18V to 19.5V). A separate menu is available for this selection.

ACV Frequency Band Selection

Ensure that the ACV menu is displayed as shown on *page 3-12* (if not, press the front panel ACV key).



Press the 1V soft key to see the 1V default menu:

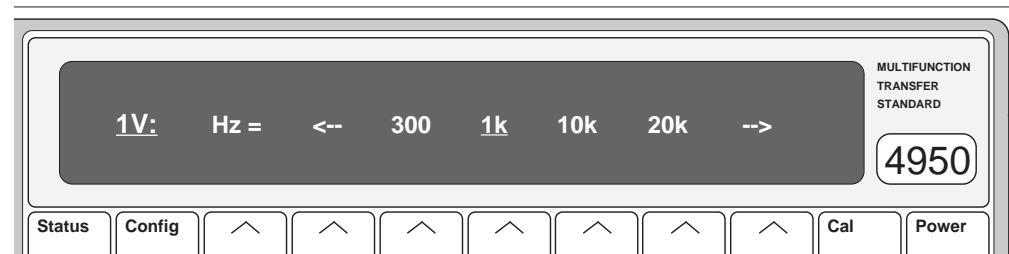

This menu defines four *choice* keys and two *menu* keys.

300; 1k; 10k, 20k:

Selection activates the corresponding frequency band; the selection is underscored by the cursor (1k is the default frequency band).

-->: Displays the 1V: 30k / 50k / 100k / 300k menu, offering a choice of higher frequency bands.

<--: Displays the 1V: 10 / 20 / 30 / 40 / 55 menu, offering a choice of lower frequency bands.



Press the <-- soft key to select the 55Hz frequency band. This also selects the 10 - 55 menu so that the selection can be seen; it is underscored. This is true whenever any <-- key is pressed, it represents the next lower frequency band, and does not just act as a menu switch. As the label exists on the next lower menu, that menu is displayed with the highest frequency band underscored.

- ➔ Press the **30** soft key to activate the 30Hz frequency band: a cursor appears under 30 on the menu.



- ➔ Press the --> key: the 300 - 20k menu appears, with 300 underscored.
- ➔ Press the --> key: the 30k - 300k menu appears, with 30k underscored.
- ➔ Press the --> key: the 500k/1M menu appears, with 500k underscored.

Any --> key represents the next higher frequency band, and does not just act as a menu switch. This is consistent with the actions of the <-- keys described earlier.

- ➔ Press the DCV key, then the ACV key: the display returns to the ACV menu. Note that the 1V range is still selected.
- ➔ Press the 100V range key and note that the 300 - 20k menu is selected, with the cursor under the 1kHz (default) selection.
- ➔ Press the ACV key, then the 1V range key and note that the 500k/1M menu is still selected, with the cursor still under the 500kHz selection.

So we can see that the frequency band selection is preserved for a particular range. Changing range or function does not destroy the association. When returning to an ACV range, the frequency band selection is as it was left on exit from the range.



Press the ACV key: the display returns to the ACV menu.
Press the 10V range key. The 1kHz frequency band is selected (default), but this not the usual type of ACV display:

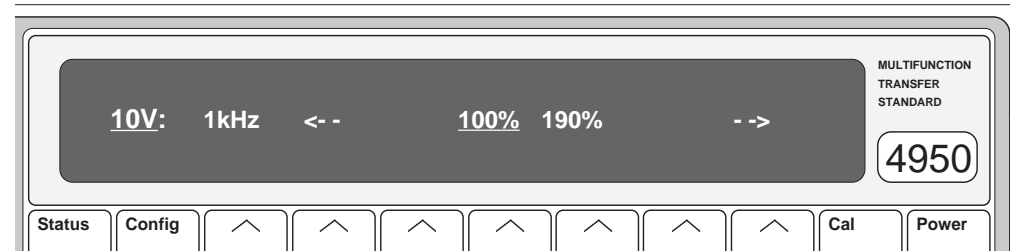

The 10V range is special. Its 1kHz frequency band is used to verify the linearity of calibrator outputs at 19V (190%), as well as measuring at nominal full range of 10V for calibration. It needs a voltage measurement band menu so that either can be selected.

All other ACV ranges and frequency bands have only one voltage measurement band: at nominal full range. To emphasize the difference, the 1k frequency band label is never underscored on the ACV 10V range menu. As soon as 1k is selected, the menu transfers to that shown above, and if 1k was already selected (either by user selection or as default), pressing the 10V range key in the ACV menu transfers to the 10V 1kHz menu directly, as we saw above.



Press the --> key: the 300 - 20k menu appears, with the 10kHz frequency band underscored.



Press the 1kHz key: the 10V 1kHz menu reappears.



Press the <-- key: the 300 - 20k menu appears, with the 300Hz frequency band underscored.

Transferring out of the 10V 1kHz menu, using either of the arrow keys, leads back into the 300 - 20k menu, selecting a higher or lower frequency band as directed by the arrow.



Press the ACV key: the display returns to the ACV menu. Note that the 10V range is still selected.



Press the 10V range key and note that the 300 - 20k menu appears, with the cursor still under the 300Hz selection, in a manner that is normal for other ranges.

So the 10V range works as other ranges; *except* that if the 1kHz frequency band has been selected (as at power on and reset), the menu display defaults to the 10V 1kHz voltage measurement band menu, instead of the standard frequency band menu.

Note that the 10V 1kHz menu combines voltage and frequency soft keys. The two arrows are *frequency* arrows, as in frequency band menus, whereas the 100% and 190% soft keys represent voltage measurement bands.

Voltage Measurement Bands

100% Band

This has the same operation limits as the single full range band at other frequencies:

Nominal Full Range $\pm 10\%$

190% Band

For the purposes of linearity verification at 19V, this measurement band operates for inputs from 18V to 19.5V.

Default Band

The 100% band is forced on entry to and exit from the 10V 1kHz frequency band.

1mV, 10mV and 100mV Ranges: 100% Band (Refer to the table on page 3-13)

The 100% measurement band on the AC millivolt ranges extends to $\pm 15\%$ of Full Range instead of the normal $\pm 10\%$.

1kV Range: 70% Band (Refer to the table on page 3-13)

The 1kV range has 100% measurement bands at frequency bands up to 30kHz. However, the frequency range is extended by two further frequency bands, at 50kHz and 100kHz, but both are limited to a 70% measurement band (600V - 800V).

ACV Configuration

(Remote Guard; 2-Wire/4-Wire Connection)



Press the Config key to see the ACV CONFIG menu:



socket Guard pin is open-circuited, and the internal guards connect to internal Lo. When Remote Guard *is* selected, the Lo connection is broken, and the internal guards connect only to the input-socket Guard pin, for connection to a common-mode point in the external circuit.

4-Wire/2-wire Connection

When ACV Config is selected for the 1V and 10V ranges at frequency bands higher than 100kHz, two additional entries '2wCct' and '4wCct' will appear in the menu:



2wCct: Selects the 2-wire measurement mode of the instrument via Hi and Lo, using independent correction factors, for use with non-Wavetek calibrators. When 2wCct is selected, changing range or frequency band defaults to 4wCct.

Return to the ACV Menu



Press the ACV key to return to the ACV menu.

AC Voltage - Movement between Menus

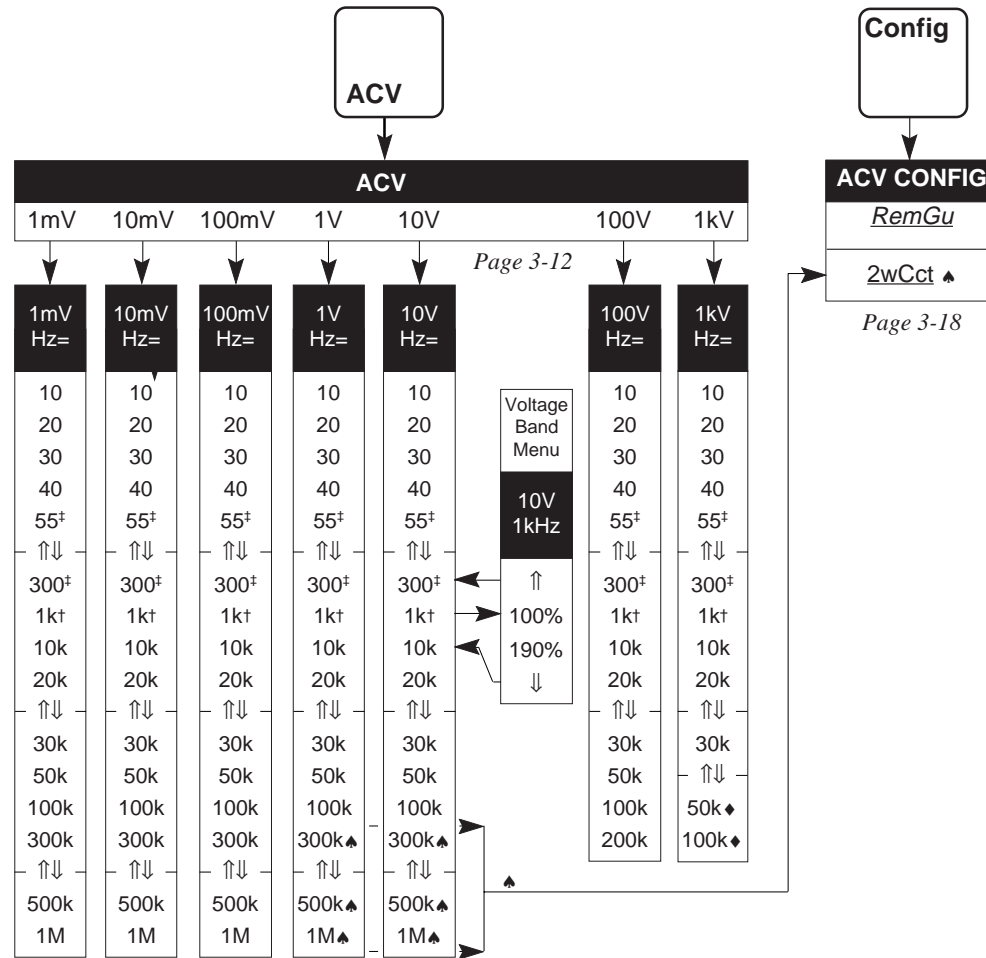

Notes:

The actions of **ACV** and **Config** hard keys are available from all the above menus.

† **1kHz** frequency band is the ACV default for all ranges.

‡ **55Hz** frequency band is extended to cover 50Hz and 60Hz applications;

300Hz frequency band is extended to cover 400Hz applications.

↓ Menu soft key provided to transfer up to the next higher frequency band.

↑ Menu soft key provided to transfer down to the next lower frequency band.

◆ **1kV** range: **50kHz** and **100kHz** frequency bands limit at **700V**.

▲ **1V & 10V** ranges, frequency bands **> 100kHz**: 2-wire measurements available via ACV Config.

Ohms

➡ Press the Ohms key to see the OHMS menu:

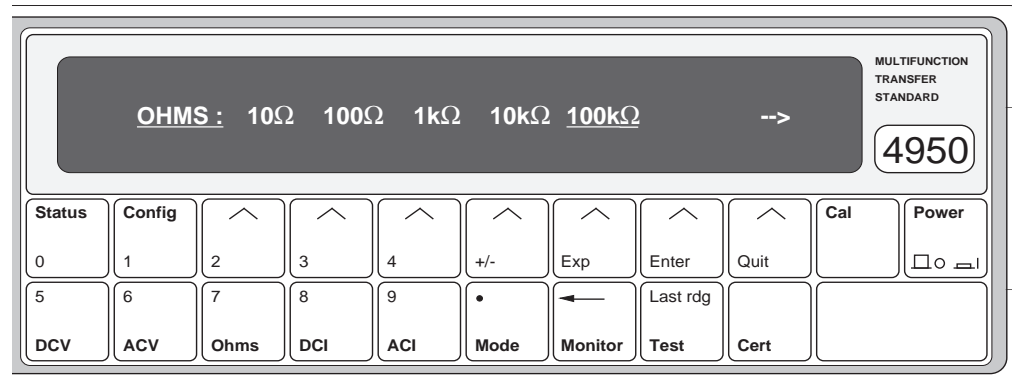

Note that the Ω symbol and the $4w\Omega$ annunciator light up on the main display.

This menu defines eight range *menu* keys in two menus (only seven soft keys available per menu). The low resistance menu is shown above, defaulted to the $100k\Omega$ range. Transfer to the high resistance menu is accomplished by pressing the special end soft-key labelled with a right arrow. The high resistance menu accesses the $1M\Omega$, $10M\Omega$ and $100M\Omega$ ranges.

➡ Press the $100k\Omega$ key to see the $100K\Omega$ range menu:

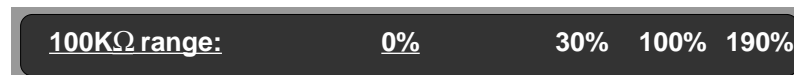

Ohms Measurement Bands

There are four main Ohms measurement bands, at 0% (Zero), 30%, 100% and 190% of Nominal Full Range. The 10Ω range has an extra band (at 10%) for measuring 1Ω , and the $100M\Omega$ range does *not* have the 190% band.

The Zero (0%) band is the power-on default on all ranges, as shown by the cursor.

Ohms Range/Band Assignments

The OHMS menu presents the Ohms ranges for users to choose a range and transfer to a Range menu, where the required Measurement Band can be assigned. Each range is unique to the Ohms function, and each band in a range is unique to that range (although it is possible that another band of the same name exists on other ranges).

Selecting a measurement band in one range has no effect on band selections in other ranges.

Once a band has been assigned to a range, the assignment is retained until it is changed on the same range menu, regardless of intermediate operation in other ranges and functions. We can show this by continuing our tour:

⇒ Press the 100% key to select the Nominal Full Range measurement band:

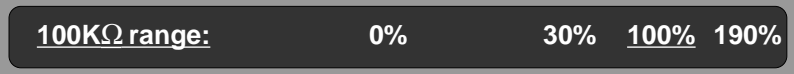

<u>100kΩ range:</u>	0%	30%	<u>100%</u>	190%
---------------------	----	-----	-------------	------

The cursor moves under 100% to indicate selection.

⇒ Press the ACV key: the ACV menu is presented.

⇒ Press the Ohms key: the OHMS menu is presented. Note that the 100kΩ range is still selected.

⇒ Press the 1kΩ key: the 1kΩ range menu is presented. Note that the default 0% measurement band is selected.

⇒ Press the 30% key: The cursor moves under 30% to indicate selection.

⇒ Press the Ohms key: the OHMS menu is presented. Note that the 1kΩ range is still selected.

⇒ Press the 100kΩ key: the 100kΩ range menu is presented. Note that the 100% measurement band is still selected.

Menu tour continues overleaf

Ohms Configuration

(Lead Serial Number; 2-wire Ohms; Remote Guard)

When in the OHMS menu or one of the Ohms range menus, pressing the Config key presents the OHMS CONFIG menu, where Ohms can be configured for two or four wire connection, and for local or remote guard connection. The power-on and reset defaults are 4-wire with local guard. Reconfiguring the 2/4-wire connection and the guard connection in Ohms has no effect on selections in other functions. Once a configuration has been chosen, it is retained for all Ohms operation until it is changed in the OHMS CONFIG menu, regardless of intermediate operation in other ranges and functions.

Two-Wire Ohms Operation

'Four-wire Ohms' is the Power-On and Reset default connection for the Ohms function. If 'Two-wire Ohms' is required, certain conditions must be met to ensure that traceable 2-wire measurements are possible.

In all 2-wire Ohms measurements, the lead forms part of the external circuitry, and the result of any measurement is in error, being greater than the resistance to be measured by the series resistance of the two leads.

The 4950 is designed to provide error correction by including the lead resistance during every measurement. This is possible only if the resistance of the lead is known; so at calibration of the Ohms function, the resistance of the 2-wire lead is characterized to establish its traceability. Subsequently, if traceability is to be maintained, the characterized lead must travel with the instrument, to be used for all 2-wire measurements.

To this end, all authorized leads are serial-numbered. The serial number of the *characterized* lead is registered in the non-volatile calibration memory of the 4950, so that users can ensure that the correct lead is connected. The correct serial number must be entered via the OHMS CONFIG menu before the 4950 will permit 2-wire Ohms measurements to proceed.

This does not prevent an incorrect lead from being used once the correct number has been entered; indeed, the STATUS CONFIG menu accesses the serial number of the characterized lead. This initial barrier is intended to remind users that **the traceability chain will be broken, if the characterized lead is not used.**

➡ Press the Config key to see the OHMS CONFIG menu:

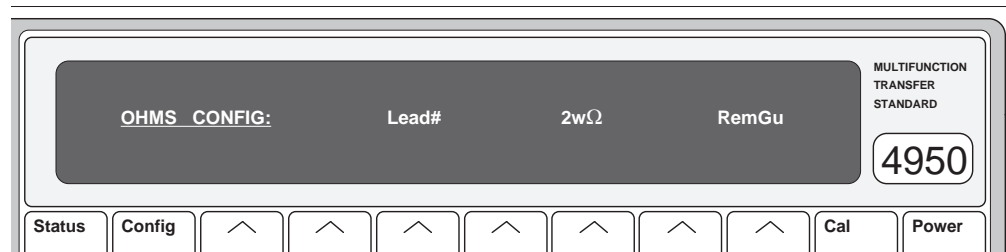

Lead#: Unless the correct serial number of the 2-wire Ohms lead has been entered since power-on, 2-wire Ohms cannot be selected.

➡ Press the Lead# soft key to gain access to the LEAD SER # menu:



At the most-recent 2-wire ohms calibration, the serial number of the 2-wire lead characterized at calibration will have been written into non-volatile memory. In order to maintain traceability, the same lead should be used for measurement; so 2-wire ohms can be selected *only* if the same serial number is entered in this menu, via the numeric keyboard (page 3-3). (The serial number of the lead is marked on the lead itself. The *correct* lead number can be found by pressing the Lead soft key in the STATUS CONFIG menu - page 3-41). If the number entered does not match that registered in non-volatile memory, access is denied, and the following error message is displayed:

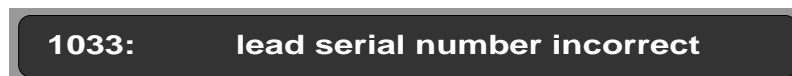

Menu tour continues overleaf

Ohms Configuration (Contd.)

2wΩ Once the correct number has been entered, the dot-matrix display returns to the OHMS CONFIG menu, then 2-wire Ohms can be selected. When successful, a cursor will be placed under the 2wΩ soft key label, and the 4wΩ annunciator on the main display will be extinguished.

If the correct number has *not* been entered since the last power-on, then 2-wire Ohms *cannot* be selected, and pressing the 2wΩ soft key will result in the following error message:

1032: 2 wire selection requires lead#



Press the Ohms key, then Config key for the OHMS CONFIG menu:

OHMS CONFIG: Lead# 2wΩ RemGu

Remote Guard

Local Guard is the power-on default for all Ohms ranges and bands. If Remote Guard is selected on any Ohms range, it is applied throughout all Ohms ranges.

RemGu: Selects Remote Guard. In Ohms function only, the Lo pin on the input socket is not connected to the internal analog common (as for other functions), but made active as the Ohms low sense connection. The internal guard screens and tracks are permanently connected to analog common. When Remote Guard *is* selected, the internal guards also connect to the input-socket Guard pin, for connection to a common-mode point in the external circuit. When Remote Guard *is not* selected, the input-socket Guard pin is open-circuited.

To indicate that Remote Guard has been selected, a cursor appears under the RemGu soft key label, and the RemGu annunciator on the main display is lit.



Press the Ohms key to return to the OHMS menu.

The selected guard configuration is memorized by the 4950 when leaving Ohms to operate in other functions, and reinstated on return to Ohms.

Ohms - Movement between Menus

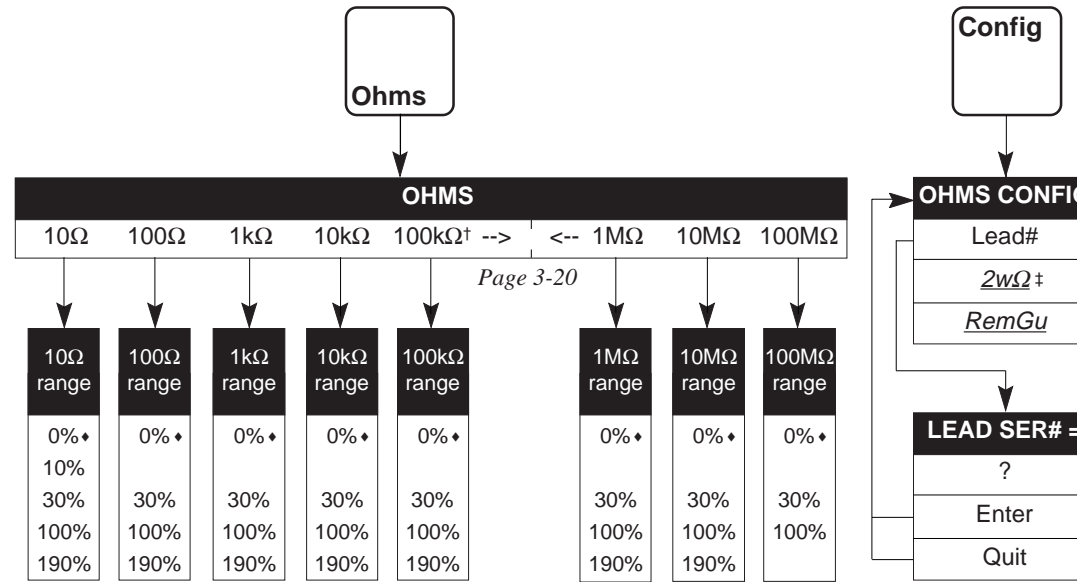

Notes:
 The actions of **Ohms** and **Config** hard keys are available from all the above menus.

- † 100kΩ is the Ohms default range.
- ♦ 0% is the Ohms default measurement band on all ranges.
- Menu soft key provided to transfer up to high resistance ranges menu.
- ← Menu soft key provided to transfer down to low resistance ranges menu.
- ‡ Selection of 2-wire ohms connection requires the correct lead serial number to have been entered in the LEAD SER # menu.

DC Current

➡ Press the DCI key to see the DCI menu:

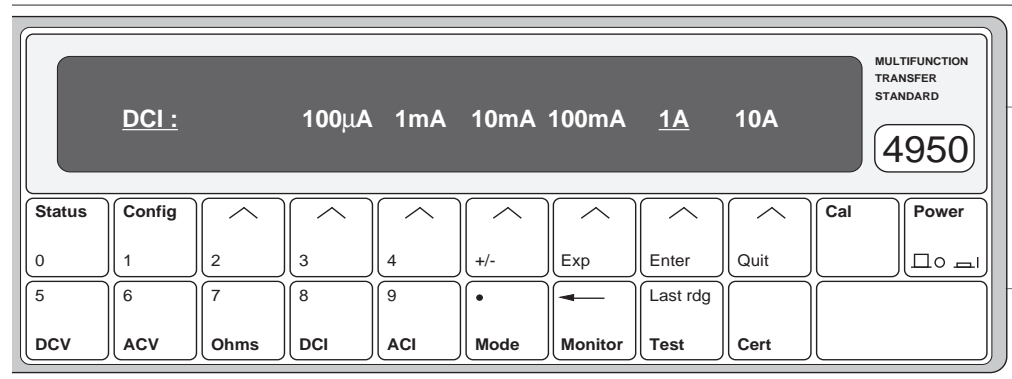

This menu defines six range *menu* keys. The 1A range is the power-on default, as shown by the cursor.

➡ Press the 1A key to see the 1A range menu:

DCI Measurement Bands

There are two DCI measurement bands, 0% (Zero), and $\pm 100\%$ of Nominal Full Range.

The Zero (0%) band is the power-on default on all ranges, as shown by the cursor.

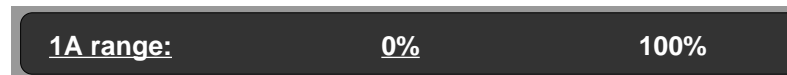

DCI Range/Band Assignments

The DCI menu presents the DCI ranges for users to choose a range and transfer to a Range menu, where the required Measurement Band can be assigned. Each range is unique to the DCI function, and each band in a range is unique to that range (although another band of the same name exists on all ranges).

Note that the traceability of the 10A range is dependent on using a designated external 10A Shunt (Model 4953), with which the 10A range will have been calibrated.

Selecting a measurement band in one range has no effect on band selections in other ranges.

Once a band has been assigned to a range, the assignment is retained until it is changed on the same range menu, regardless of intermediate operation in other ranges and functions. We can show this by continuing our tour:

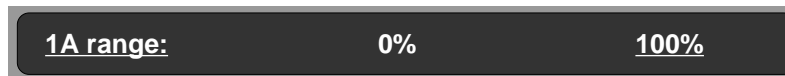

- ➡ Press the 100% key to select the Nominal Full Range measurement band: The cursor moves under 100% to indicate selection.
- ➡ Press the ACV key: the ACV menu is presented.
- ➡ Press the DCI key: the DCI menu is presented. Note that the 1A range is still selected.
- ➡ Press the 100mA key: the 100mA range menu is presented. Note that the default 0% measurement band is selected.
- ➡ Press the 100% key: The cursor moves under 100% to indicate selection.
- ➡ Press the DCI key: the DCI menu is presented. Note that the 100mA range is still selected.
- ➡ Press the 1A key: the 1A range menu is presented. Note that the 100% measurement band is still selected.

Menu tour continues overleaf

DCI Configuration

(10A Shunt Serial Number; Remote Guard)

When in the DCI menu or one of the DCI range menus, pressing the **Config** key presents the DCI CONFIG menu, where DCI can be configured for local or remote guard connection. The power-on and reset default is local guard. Reconfiguring the guard connection in DCI has no effect on selections in other functions. Once a configuration has been chosen, it is retained for all DCI operation until it is changed in the DCI CONFIG menu, regardless of intermediate operation in other ranges and functions.

DCI 10A Operation

At Power-On and Reset state the default condition is DCI 10A range disabled. If the 10A range is required, the serial number of the designated Model 4953 10A external shunt needs to be entered to guarantee traceable 10A measurements. The 4953 is described in *Appendix A to Section 1*.

In all DCI 10A measurements, the shunt forms part of the external circuitry, and the result of any measurement is not traceable if the wrong shunt is used, whether or not the shunt value is the same as the correct one.

The 4950 provides error correction during every measurement. This is possible only if the value of the shunt is known; so at calibration of the DCI function, the 4953 value is characterized in non-volatile memory to establish its traceability. Subsequently, if traceability is to be maintained, the characterized 4953 must travel with the instrument, to be used for all 10A DCI measurements.

To this end, all authorized 4953 shunts are serial-numbered. The serial number of the *characterized* 4953 is registered in 4950 non-volatile memory, so that users can ensure that the correct shunt is connected. The correct serial number must be entered via the DCI CONFIG or ACI CONFIG menu before any DCI 10A measurements can proceed.

This does not prevent an incorrect shunt from being used once the correct number has been entered; indeed, the STATUS CONFIG menu accesses the serial number of the characterized shunt. This initial barrier is intended to remind users that **the traceability chain will be broken, if the characterized shunt is not used.**



Press the Config key to see the DCI CONFIG menu:



Shunt#: Unless the correct serial number of the 10A shunt has been entered since power-on, the DCI 10A range cannot be selected.



Press the Shunt# soft key to gain access to the 10A SHUNT SER # menu:



At the most-recent DCI 10A calibration, the serial number of the shunt used for calibration will have been written into firmware. In order to maintain traceability, the same shunt should be used for measurement; so the DCI 10A range can be selected *only* if the same serial number is entered in this menu, via the numeric keyboard (*page 3-3*). (The serial number of the shunt is marked on the shunt itself. The *correct* shunt number can be found by pressing the **Shunt** soft key in the STATUS CONFIG menu - *pages 3-39 to 44*.) If the number entered does not match that registered in non-volatile memory, access is denied, and the following error message is displayed:

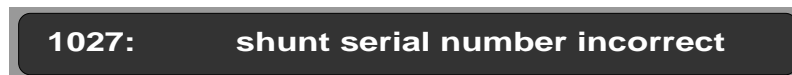

10A range Once the correct number has been entered, then the 10A range can be selected in the DCI menu. When successful, the cursor will be placed under the 10A soft key label.

Menu tour continues overleaf

DCI Configuration (Contd.)

If the correct number has *not* been entered since the last power-on, then the DCI 10A range *cannot* be selected, and pressing the 10A soft key will result in the following error message:



1028: 10A selection requires shunt#



Press the DCI key then Config key for the DCI CONFIG menu:



DCI CONFIG:

Shunt#

RemGu

Remote Guard

Local Guard is the power-on default for all DCI ranges and bands. If Remote Guard is selected while in any DCI range, it is applied throughout all DCI ranges.

RemGu: Selects Remote Guard. When Remote Guard *is not* selected, the input-socket Guard pin is open-circuited, and the internal guards connect to internal Lo. When Remote Guard *is* selected, the Lo connection is broken, and the internal guards connect only to the input-socket Guard pin, for connection to a common-mode point in the external circuit.

To indicate that Remote Guard has been selected, a cursor appears under the RemGu soft key label, and the RemGu annunciator on the main display is lit.



Press the DCI key to return to the DCI menu.

The selected guard configuration is memorized by the 4950 when leaving DCI to operate in other functions, and reinstated on return to DCI.

DC Current - Movement between Menus

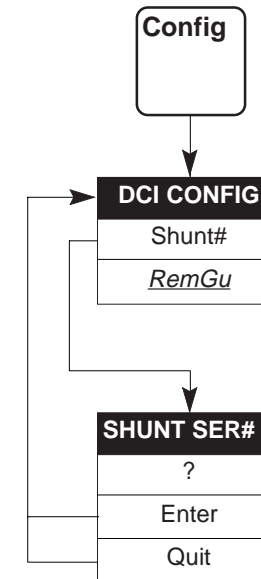
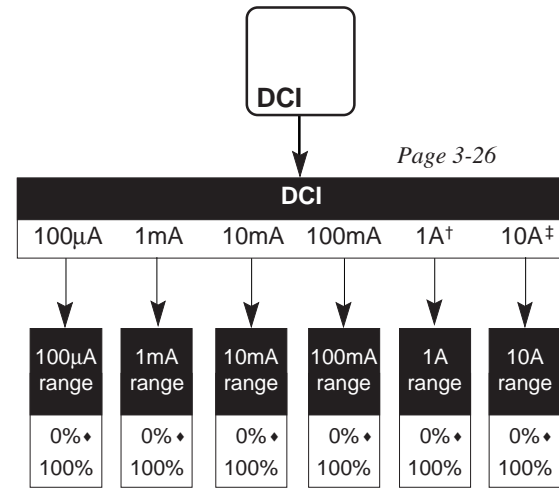

Page 3-28

Notes:

The actions of **DCI** and **Config** hard keys are available from all the above menus.

† 1A is the DCI default range.

◆ 0% is the DCI default measurement band on all ranges.

‡ Selection of DCI 10A range requires the correct 4953 external shunt serial number to have been entered in the SHUNT SER # menu.

AC Current

➡ Press the ACI key to see the ACI menu:

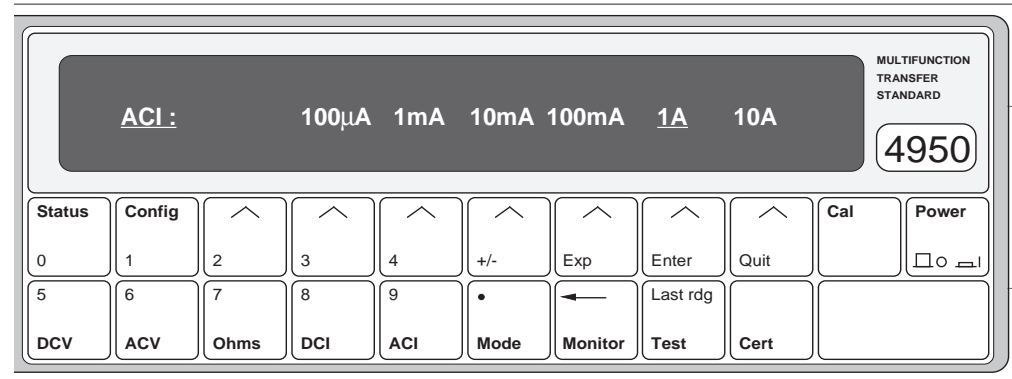

This menu defines six range *menu* keys. The 1A range is the power-on default, as shown by the cursor.

➡ Press the 1A key to see the 1A range menu:

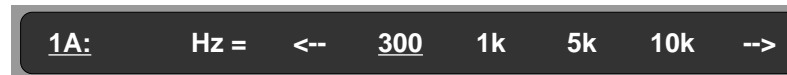

Because ACI is defined in frequency as well as current value, an extra layer of menus is needed for selection.

Frequency Bands

As the 4950 is intended to calibrate calibrators, in this case AC Current sources, measurement of a continuous range of frequencies is unnecessary. Confining the response of the instrument to a series of frequency bands, operable within $\pm 10\%$ of a nominal center frequency, targets a large number of calibration points used by AC current calibrators. Moreover, although each frequency band has its own correction, the frequency response errors due to maintaining a wideband spectrum are drastically reduced. This allows closer tolerances to be placed on the current values in each band, improving the overall accuracy.

Frequency Band Selection

Most frequency bands are available on every AC Current range, but not all. The table shows the allocation of frequency bands to ranges; only the starred range/frequency-band combinations are available.

Available Range/Frequency-Band Combinations

Range	Frequency Band (Hz)										
	10	20	30	40	55 §	300* §	1k	5k	10k	20k	30k
100µA	*	*	*	*	*→	←*	*	*	*→	←*	*
1mA	*	*	*	*	*→	←*	*	*	*→	←*	*
10mA	*	*	*	*	*→	←*	*	*	*→	←*	*
100mA	*	*	*	*	*→	←*	*	*	*→	←*	*
1A †	*	*	*	*	*→	←*	*	*	*→	←*	*
10A ‡	*	*	*	*	*→	←*	*	*	*→	←*	*

Notes:

- † 1A is the ACI default range.
- ◆ The 300Hz frequency band is the ACI default for all ranges.
- § The 55Hz frequency band is extended to cover both 50Hz and 60Hz.
The 300Hz frequency band is extended to cover 400Hz.
- Menu soft key provided to transfer up to the high frequency band menu.
- ← Menu soft key provided to transfer down to the low frequency band menu.
- ‡ Selection of ACI 10A range requires the correct shunt serial number to have been entered in the SHUNT# menu.

Frequency Band Menus

In the above table, frequency bands are grouped according to the menus in which they appear. Transfer from one menu to the other is accomplished using special end soft-keys labelled with a right or left arrow (as in the table).

No Measurement Band Menus

There is only one ACI measurement band: Nominal Full Range (100%, ±10%). No measurement band menus are required.

Menu tour continues overleaf

ACI Range/Frequency-Band Assignments

The ACI menu presents the ACI ranges for users to choose a range and transfer to a Range menu, where the required Frequency Band can be assigned. Each range is unique to the ACI function, and each band in a range is unique to that range (although another band of the same name may exist on all ranges). Selecting a frequency band in one range has no effect on band selections in other ranges.

Once a band has been assigned to a range, the assignment is retained until it is changed on the same range menu, regardless of intermediate operation in other ranges and functions. We can show this by continuing our tour, which we left in the 1A range with the default 300Hz frequency band selected:

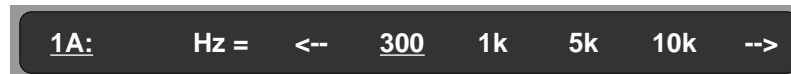

1A: Hz = <-- 300 1k 5k 10k -->

- ➡ Press the 1k key: The cursor moves under 1k to indicate selection.
- ➡ Press the DCI key: the DCI menu is presented.
- ➡ Press the ACI key for the ACI menu. The 1A range is still selected.
- ➡ Press the 100mA key: the 100mA range menu is presented. The default 300Hz frequency band is selected.
- ➡ Press the <-- key to transfer to the 55Hz band on the LF band menu:



100mA: Hz = 10 20 30 40 55 -->

- The cursor moves under 55 to indicate selection.
- ➡ Press the 40 key: The cursor moves under 40 to indicate selection.
- ➡ Press the ACI key: the ACI menu is presented. Note that the 100mA range is still selected.
- ➡ Press the 1A key: the 1A range mid-frequency band menu is presented. Note that the 1k frequency band remains selected.
- ➡ Enter the high frequency band menu (20kHz & 30kHz bands) by pressing the --> key to note the 20kHz & 30kHz band labels, then press the <-- key to revert to the mid-frequency band menu.

ACI Configuration

(10A Shunt Serial Number; Remote Guard)

When in the ACI menu or one of the ACI range menus, pressing the Config key presents the ACI CONFIG menu, where ACI can be configured for local or remote guard connection. The power-on and reset default is local guard. Reconfiguring the guard connection in ACI has no effect on selections in other functions. Once a configuration has been chosen, it is retained for all ACI operation until it is changed in the ACI CONFIG menu, regardless of intermediate operation in other ranges and functions.

ACI 10A Operation

At Power-On and Reset state the default condition is ACI 10A range disabled. If the 10A range is required, the serial number of the designated Model 4953 10A external shunt needs to be entered to guarantee traceable 10A measurements. The 4953 is described in *Appendix A to Section 1*.

In all ACI 10A measurements, the shunt forms part of the external circuitry, and the result of any measurement is not traceable if the wrong shunt is used, whether or not the shunt value is the same as the correct one.

The 4950 provides error correction during every measurement. This is possible only if the value of the shunt is known; so at calibration of the ACI function, the 4953 value is characterized in non-volatile memory to establish its traceability. Subsequently, if traceability is to be maintained, the characterized 4953 must travel with the instrument, to be used for all 10A ACI measurements.

To this end, all authorized 4953 shunts are serial-numbered. The serial number of the *characterized* 4953 is registered in 4950 non-volatile memory, so that users can ensure that the correct shunt is connected. The correct serial number must be entered via the DCI CONFIG or ACI CONFIG menu before any ACI 10A measurements can proceed.

This does not prevent an incorrect shunt from being used once the correct number has been entered; indeed, the STATUS CONFIG menu accesses the serial number of the characterized shunt. This initial barrier is intended to remind users that **the traceability chain will be broken, if the characterized shunt is not used.**

ACI Configuration (Contd.)

➡ Press the Config key to see the ACI CONFIG menu:



Shunt#: Unless the correct serial number of the 10A shunt has been entered since power-on, the ACI 10A range cannot be selected.

➡ Press the Shunt# soft key to gain access to the 10A SHUNT SER # menu:



At the most-recent ACI 10A calibration, the serial number of the shunt used for calibration will have been written into non-volatile memory. In order to maintain traceability, the same shunt should be used for measurement; so the ACI 10A range can be selected *only* if the same serial number is entered in this menu, via the numeric keyboard (*page 3-3*). (The shunt serial number is marked on the shunt itself. The *characterized* shunt number can be found by pressing the shunt soft key in the STATUS CONFIG menu - *pages 3-39 to 3-44*.) If the number entered does not match that registered in non-volatile memory, access is denied, and the following error message is displayed:



10A range Once the correct number has been entered, then the 10A range can be selected in the ACI menu. When successful, the cursor will be placed under the 10A soft key label.

If the correct number has *not* been entered since the last power-on, then the ACI 10A range *cannot* be selected, and pressing the 10A soft key will result in the following error message:



1028: 10A selection requires shunt#



Press the ACI key then the Config key the ACI CONFIG menu:



ACI CONFIG: Shunt# RemGu

Remote Guard

Local Guard is the power-on default for all ACI ranges and bands. If Remote Guard is selected while in any ACI range, it is applied throughout all ACI ranges.

RemGu: Selects Remote Guard. When Remote Guard *is not* selected, the input-socket Guard pin is open-circuited, and the internal guards connect to internal Lo. When Remote Guard *is* selected, the Lo connection is broken, and the internal guards connect only to the input-socket Guard pin, for connection to a common-mode point in the external circuit.

To indicate that Remote Guard has been selected, a cursor appears under the RemGu soft key label, and the RemGu annunciator on the main display is lit.



Press the ACI key to return to the ACI menu.

The selected guard configuration is memorized by the 4950 when leaving ACI to operate in other functions, and reinstated on return to ACI.

Menu tour continues overleaf

AC Current - Movement between Menus

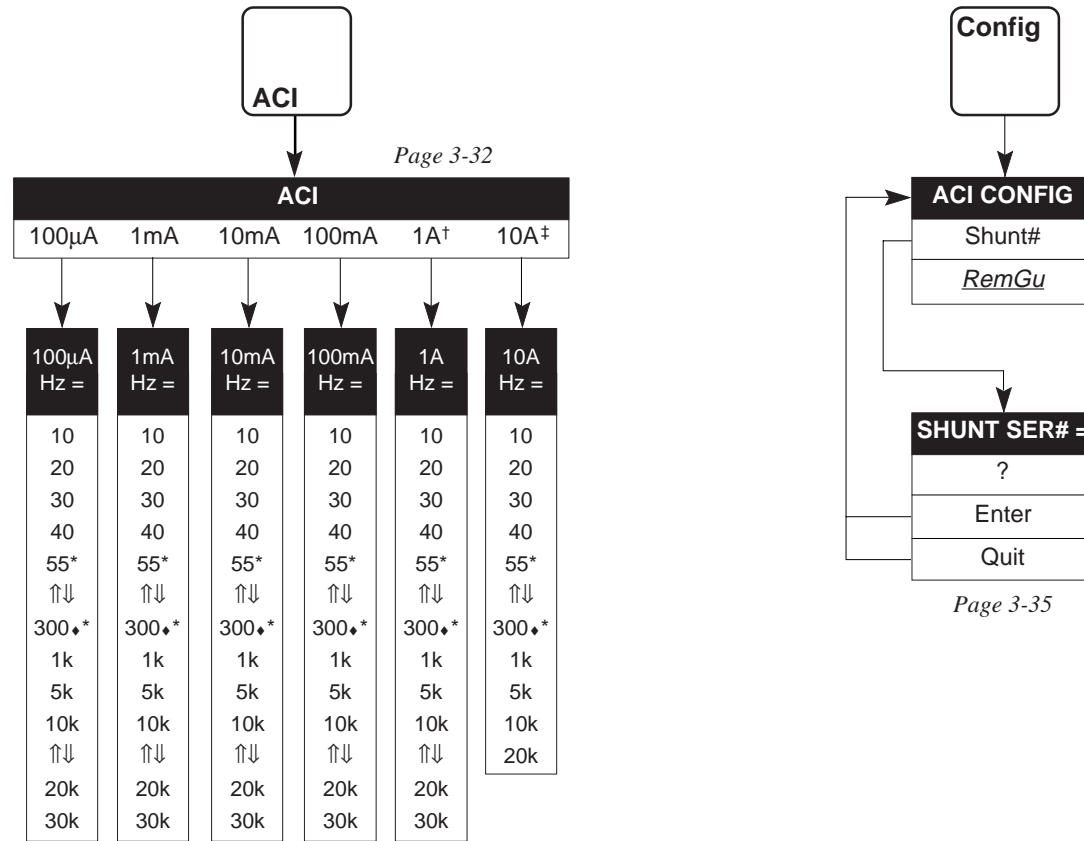

Notes:

The actions of **ACI** and **Config** hard keys are available from all the above menus.

† 1A is the ACI default range.

◆ 300Hz is the ACI default measurement band on all ranges.

* 55Hz frequency band is extended to include line power frequencies of 50Hz and 60Hz.

* 300Hz frequency band is extended to include line power frequency of 400Hz.

‡ Selection of ACI 10A range requires the correct 4953 external shunt serial number to have been entered in the SHUNT# menu.

↓ Menu soft key provided to transfer up to a higher frequency band menu.

↑ Menu soft key provided to transfer down to a lower frequency band menu.

'Status' Key

So far in this section, we have concentrated on the menus of the keys which select the type of physical quantity to be measured - we call them the Main Function keys. With these, we can configure the functions so that basic measurements conform to our requirements. Obviously the instrument is capable of more sophisticated operations than just taking straightforward measurements.

These are discussed in subsequent sections, but there is another key which is relevant to basic measurements.

Status Key

Using the **Status** key, we can review the instrument parameters which are currently set up, over and above those indicated by the annunciators on the main display.

Using the **Status** and **Config** keys, we can see the serial number of the instrument and the issue number of the currently-installed firmware. The serial numbers of the two-wire Ohms lead and 10A shunt whose parameters have been characterized during the most recent calibration. In addition, the IEEE 488 bus address can be displayed and changed if required.

Status Report

When power is switched on, the STATUS display appears automatically on the dot-matrix display, counting down the remaining warm-up period (refer to *page 3-5*). Once this period has expired, the display presents a summary of the current instrument state. The following sequence describes this summary.



Press the **Status** key to see the STATUS report:

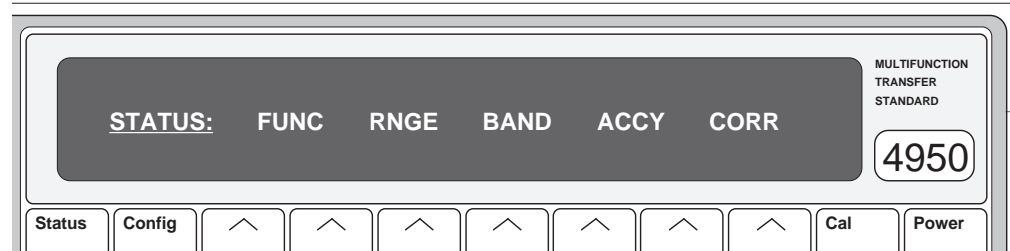

Status reports the most-recent selections from the various menus. It can be used to check that the instrument state is suitable for the measurement being made.

The legends shown in the above diagram do **not** actually appear, they only mark the positions of legends which can appear. Each merely acts as a key to the list below. The meaning and possible parameters which appear in each position are given in the list:

Abbr.	Meaning	Possible Parameters
FUNC	Function:	DCV, ACV, OHM, DCI, ACI.
RNGE	DC Voltage Range:	1mV, 10mV, 100mV, 1V, 10V, 19V, 100V, 1kV;
	AC Voltage Range:	1mV, 10mV, 100mV, 1V, 10V, 19V, 100V, 700V, 1kV;
	Ohms Range:	10Ω, 100Ω, 1kΩ, 10kΩ, 100kΩ, 1MΩ, 10MΩ, 100MΩ;
	Current Range:	100μA, 1mA, 10mA, 100mA, 1A, 10A.
BAND	Measurement Band:	0%, 10%, 30%, 100%, 190%.
	Frequency Band:	10Hz, 20Hz, 30Hz, 40Hz, 55Hz, 300Hz, 1kHz, 5kHz, 10kHz, 20kHz, 30kHz, 50kHz, 100kHz, 200kHz, 300kHz, 500kHz, 1MHz.
ACCY	Accuracy:	LoAcc, HiAcc.
CORR	Certified Corrections:	blank or CERT.

Status Configuration

(Two-Wire Ohms Lead Serial Number, 10A Shunt Serial Number, Instrument Serial Number/Software Issue and IEEE 488 Bus Address)

The following STATUS CONFIG menu is available both during, and after expiry of, the instrument warm-up period.



Press the Config key to see the STATUS CONFIG menu:

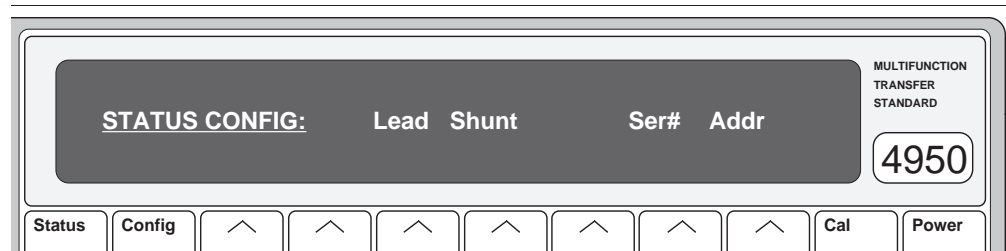

This is a menu, defining the following menu keys.

- Lead: displays the LEAD SERIAL # menu, to see the serial number of the 2-wire Ohms lead which was characterized by this instrument during the most-recent calibration.
- Shunt: displays the SHUNT SERIAL # menu, to see the serial number of the 10A shunt which was characterized by this instrument during the most-recent calibration.
- Ser#: displays the SER# menu, to review the serial number and software issue of the instrument.
- Addr: displays the ADDRESS menu, to review and change the IEEE-488 bus address of the instrument.

Menu tour continues overleaf

LEAD SERIAL NUMBER



Press the **Lead** key to see the LEAD SERIAL # = display:

LEAD SERIAL # = 1234567890ab 0.0003Ω

This displays the serial number of the characterized 2-wire Ohms lead, and its measured resistance. Unless this particular lead is the one employed when using the 2-wire Ohms facility, the measurements will not be traceable.



Transfer from the LEAD SERIAL # = display back to the STATUS CONFIG menu by pressing the **Config** key.

SHUNT SERIAL NUMBER



Press the **Lead** key to see the SHUNT SERIAL # = display:

SHUNT SERIAL # = 1234567890ab

This displays the serial number of the characterized 10A shunt. Unless this particular shunt is the one employed when using the DCI and ACI 10A ranges, the measurements will not be traceable.



Transfer from the SHUNT SERIAL # = display back to the STATUS CONFIG menu by pressing the **Config** key.

INSTRUMENT SERIAL NUMBER and SOFTWARE ISSUE NUMBER

➡ Press the **Ser#** soft key to see the **SER# =** display.

SER # = 1234567890ab S/W ISS 01.01

This display is for information only. Inspect the instrument serial number and software issue number. The serial number cannot be altered except in one of the calibration menus, and this facility is only provided for use during manufacture. Once changed, the number is not lost when the instrument power is turned off. The software issue number (last four digits) is embedded in the software itself, and is not user-alterable.

➡ Transfer from the **SER # =** display back to the **STATUS CONFIG** menu by pressing the **Config** key.

IEEE 488 ADDRESS Menu

➡ Press the **Addr** key to see the **IEEE 488 ADDRESS =** menu:

ADDRESS = 23 Enter Quit

This menu permits entry of a value to be used as an IEEE-488 bus address.

Initially, the menu displays the present address value, and the numeric-keyboard keys are activated. Any valid numeric value (0-30) may be entered.

Pressing **Enter** stores the new value (or restores the old value if unchanged), but pressing **Quit** leaves the old value intact.

Either **Enter** or **Quit** causes exit back to the **STATUS CONFIG** menu.

➡ Now end this tour of the main menus. Transfer from the **ADDRESS =** menu back to the **STATUS** menu by pressing the **Status** key.

Menu tour concludes overleaf

Status Reporting - Movement between Menus

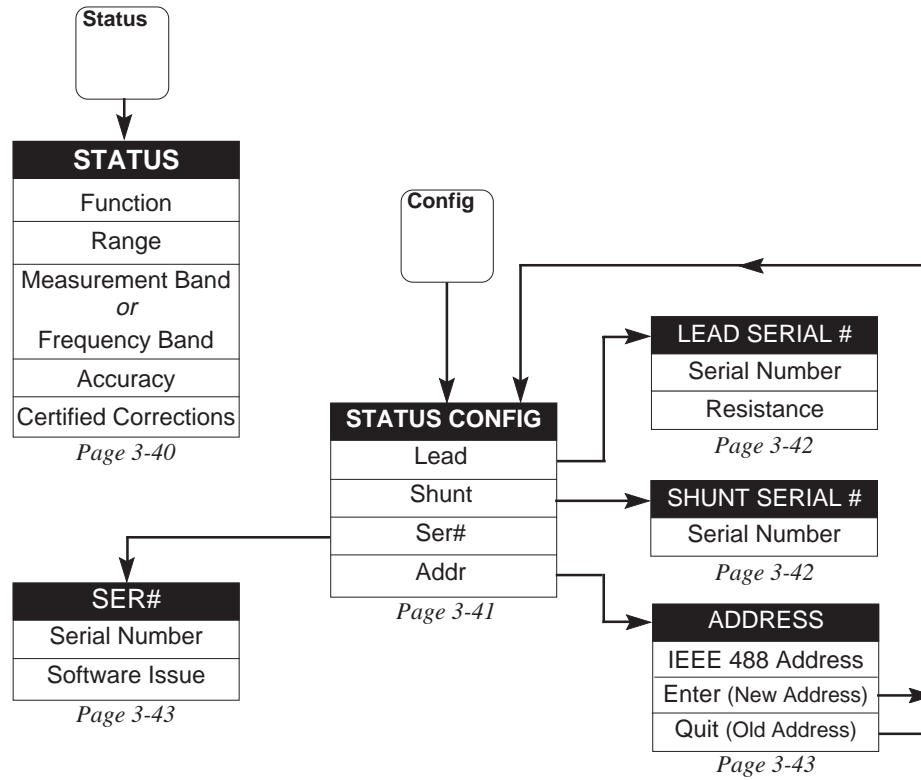

Note: The actions of **Status** and **Config** hard keys are available from all Status menus.

Conclusion

We have now come to the end of our introductory tour of the main menu keys. This is, however, far from the end of the instrument's facilities. Now you are more familiar with the operation of the front panel, it is not necessary to continue in the same sort of programmed way.

Section 4 deals with the manual selection of the facilities not covered here, and Section 5 is devoted to the operation of the instrument via the IEEE 488 Interface.

You will find that the information in Sections 4 and 5 is presented in a more concise and accessible form than here in Section 3. Your familiarity with the instrument will allow you to progress rapidly to the facilities you wish to investigate.

SECTION 4 Using the 4950

Preliminaries

This section details the methods of using the 4950, divided so as to provide an easy reference for particular functions and facilities. The divisions are as follows:

Instrument Configuration

Instrument stability status; status reporting; instrument identity; associated 2-wire ohms lead serial no.; associated 10A shunt serial no.; temperature status; calibration dates.

Measurement Definition

Functions:

DC Voltage; AC Voltage; Resistance;
DC Current; AC Current.

Within the function menus, individual measurement parameters are selected from: Range; frequency band; measurement band; two-wire/four-wire ohms; local/remote guard.

Measurement Parameters:

Measurement samples; accuracy mode; correction mode; trigger source selection.

Measurement Results

Sample mean value; quality (sample standard deviation; sample size); signal frequency (AC only).

Selftest Operations

Confidence test; display test; keyboard test.

Direct Action Keys

Reset; Ext'trig; Sample; Local; SRQ; Caltrig and Zero.

Calibration Operations

Calibration at nominal and non-nominal target values; internal clock correction; entry of date and time of calibration; entry of ambient temperature at calibration; characterizing 2-wire ohms lead and exit from Calibration mode.

Installation

WARNING Read the Safety Issues section at the front of this manual before installing, using or servicing this instrument.



CAUTION Before using the instrument, it is important that it has been correctly installed as detailed in Section 2.



Limiting Characteristics

Maximum inputs are detailed in Section 6.

Safety

The model 4950 is designed to meet the safety requirements of UL 1244, ANSI C39.5 (Draft 5) and EN61010:1993/A2:1995.. See the Safety Issues section at the front of this manual.

Interconnections - General Guidelines

Importance of Correct Connections

The 4950 is capable of providing highly accurate traceable measurements. To attain this, it is necessary to make correct connection to any external

circuitry or load. A few general guidelines for correct external connection are given in the following paragraphs.

Sources of Error

Thermal EMFs

These can give rise to series (Normal) mode interference, particularly where large currents have a heating effect at junctions. In otherwise thermoelectrically-balanced measuring circuits, cooling caused by draughts can upset the balance.

E-M Interference

Noisy or intense electric, magnetic and electromagnetic effects in the vicinity can disturb the measurement circuit. Some typical sources are:

- Proximity of large static electric fields.
- Fluorescent lighting.
- Inadequate screening, filtering or grounding of power lines.
- Transients from local switching.
- Induction and radiation fields of local E-M transmitters.
- Excessive common mode voltages between source and load.

The disturbances can be magnified by the user's hand capacitance. Electrical interference has greatest effect in high impedance circuits. Separation of leads and creation of loops in the circuit can intensify the disturbances.

Lead Resistance

The resistance of the connecting leads can drop significant voltages between the source and load, especially at high load currents.

Lead Insulation Leakage

This can cause significant errors in measurement circuits at high voltages. Some insulating materials suffer greater losses than others, e.g. PVC has more leakage than PTFE.

Avoidance Tactics

Thermal EMFs:

- Screen thermal junctions from draughts.
- Allow time for thermal equilibrium to be reached before taking readings.
- Use conductors, joints and terminals with a good margin of current-carrying capacity.
- Avoid thermoelectric junctions where possible:
 - Use untinned single-strand copper wire of high purity.
 - Avoid making connections through Nickel, Tin, Brass and Aluminium. If oxidation is a problem use gold-plated copper terminals, and replace the terminals before the plating wears off.
 - If joints must be soldered, low-thermal solders are available, but crimped joints are preferred.
 - Use low-thermal switches and relays where they form part of the measuring circuit.
 - Balance one thermal EMF against another in opposition, where possible. (Switch and relay contacts, terminals etc.)

E-M Interference:

- Choose as “quiet” a site as possible (a screened cage may be necessary if interference is heavy). Suppress as many sources as possible. (Refer also to *Section 2, Page 2-7*)
- Always keep interconnecting leads as short as possible, especially unscreened lengths.
- Run leads together as twisted pairs in a common screen to reduce loop pick-up area, but beware of leakage problems and excessive capacitance.
- Where both source and load are floating, connect Lo to ground at the source to reduce common mode voltages.

Lead Resistance:

- Keep all leads as short as possible.
- Use conductors with a good margin of current-carrying capacity.
- Use Remote Guard or 4-wire connections where necessary.

Lead Insulation Leakage:

Choose low loss insulated leads - PTFE is preferred to PVC. When running leads together in screened pairs, avoid large voltages between leads in the same screen, especially if using PVC insulation.

Instrument Configuration

Instrument Status

Power On and Warm-up

Instrument Stability and Traceability

Lengthy stabilization time is required due to the 4950's task as a *transfer standard*. Its role is to transfer traceable accuracy from a 'Hub' Standards Laboratory to remote calibrators, as part of a calibration scheme (*Section 1, page 1-2/3*). In each scenario, the 4950 receives 'Certified' calibration at the Hub under stringent conditions of temperature stability. To preserve traceability, these conditions need to be reproduced during subsequent transfers.

4950 Stability Status Report

When power is switched on, the 4950 STABILITY status report appears automatically on the dot matrix display, showing the time remaining to complete the warm-up period.



During any stabilization period, pressing the front panel **Status** key also presents this report.

Interruption of Line Power

If line power is interrupted, during or after warm-up, more stabilization time is imposed. The internal calculation for this extra stabilization period appears in *Section 3, page 3-5*.

Status Summary after Stabilization

Once the 4950 has stabilized, pressing the **Status** key presents a summary of the current instrument operational state (*Section 3, page 3-40*).

Instrument Identity

Serial Number and Software Issue

Status Menu

At most times, the instrument serial number can be confirmed by first pressing the front panel **Status** key, followed by the **Config** key. This will open the STATUS CONFIG menu:

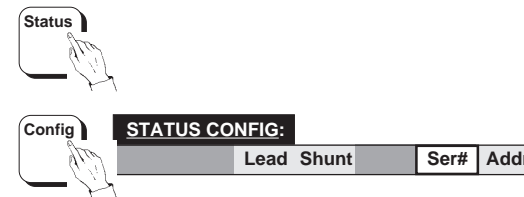

Then pressing the soft **Ser#** key will present the SER # = display:



Further details are given in *Section 3, page 3-43*.

IEEE 488 Address

Status Menu

At most times, to confirm or change the IEEE 488 address of the instrument, press the front panel **Status** key, followed by the **Config** key. This will open the STATUS CONFIG menu on the dot-matrix display as above. Then press the soft **Addr** key to show the ADDRESS = menu:



Further details are given in *Section 5, page 5-4*.

Identifying Traceable Accessories

Characterized 2-Wire Ohms Lead

Status Menu

At most times, to determine the serial number of the 2-wire Ohms lead which was characterized by this instrument at the most-recent Ohms calibration, press the front panel **Status** key, followed by the **Config** key as before. This opens the STATUS CONFIG menu on the dot-matrix display. Then press the soft **Lead** key for the LEAD SERIAL # = presentation:

LEAD SERIAL # =
1234567890ab 0.0003Ω

This display shows the serial number of the characterized 2-wire Ohms lead and its measured resistance of Hi and Lo in series. Unless this particular lead is the one employed when using the 2-wire Ohms facility, the measurements will not be traceable.

This presentation is provided only to identify the correct lead for 2-wire Ohms operation. As a constraint when first selecting the facility after power on, the OHMS CONFIG menu (*page 4-15*) must be opened to enter the correct lead serial number. Otherwise 2wΩ cannot be selected.

Neither the lead serial number nor its characterized resistance can be changed in this presentation. They can only be altered during a specific lead characterization operation when in Calibration mode.

Designated 10A Shunt

Status Menu

At most times, to determine the serial number of the 10A shunt which was designated by this instrument at the most-recent DCI or ACI calibration, press the front panel **Status** key, followed by the **Config** key as before. This opens the STATUS CONFIG menu on the dot-matrix display. Then press the soft **Shunt** key for the SHUNT SERIAL # = presentation:

SHUNT SERIAL # =
1234567890ab

This display shows the serial number of the designated shunt. Unless this particular shunt is the one employed when using the DCI and ACI 10A ranges, measurements will not be traceable.

This presentation is provided only to identify the correct shunt for 10A range operation. As a constraint when first selecting one of these ranges after power on, the DCI CONFIG or ACI CONFIG menu (*pages 4-18 and 4-23* respectively) must be opened to enter the correct shunt serial number. Otherwise the 10A range cannot be selected.

The shunt serial number cannot be changed in this presentation. It can be altered only during a specific operation when in Calibration mode.

Instrument Configuration (Contd.)

Temperature Status

Internal Temperature; Calibration Temperatures

Monitor Menu

The MONITOR menu gives access to read the current internal temperature of the instrument, and the ambient temperature at which Certified Calibration was last carried out. The differences between the current internal temperature and the internal temperatures at (a) Certified Calibration and (b) Baseline Calibration can also be read.

Current Internal Temp. Ambient Temp. at Certified Calibration

At most times, to read the current internal temperature of the instrument and the Certified Calibration ambient temperature, press the front panel Monitor key. This will open the MONITOR menu on the dot-matrix display:



Press the Temp soft key to see the TEMPERATURE menu:



Then press the Intl soft key to see the INTERNAL TEMP display, showing the current internal temperature of the instrument and the Certified Calibration ambient temperature:



Differences between the Present Internal Temperature and Internal Temperatures at Calibration

At most times, to read the differences between the present internal temperature and the internal temperatures at (a) 'Baseline' and (b) 'Certified' Calibration, press the front panel Monitor key. This will open the MONITOR menu on the dot-matrix display as before.

Press the Temp soft key to see the TEMPERATURE menu:



Then press the Diff soft key to see the TEMP DIFF display, showing the differences between the present internal temperature and the internal temperatures at Baseline and Certified Calibration:



Calibration Calendar

Most-Recent Calibration Dates; Present Time

Monitor Menu

The MONITOR menu gives access to read the dates of the most-recent Baseline and Certified calibrations of the instrument, and a readout of the present time (this readout is not dynamic, and relates only to the time that it is presented).

Baseline and Certified Calibration Dates

At most times, to read the most-recent Baseline and Certified Calibration dates of the instrument, press the front panel Monitor key. This will open the MONITOR menu on the dot-matrix display:

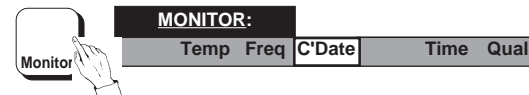

Press the C'Date soft key to see the BASE/CERT display e.g.:

BASE : 13 Jan 91	CERT : 12 Sep 92
------------------	------------------

Present Time

To read the present time, press the front panel Monitor key. This will open the MONITOR menu on the dot-matrix display as before.

Press the Time soft key for the TIME display e.g.:

TIME:
15hr 21min 14 Jun 93

Repeat these operations to update the display.

Monitor Menu - Other Options

Frequency and Quality Keys

Freq Key

This key is used to obtain the frequency of the signal being measured. It is available only when ACV or ACI function is selected, and is described under the heading of 'Measurement Results' on *page 4-29*.

Qual Key

This key is used to ascertain the quality of the most recent measurement sample. It is not available from power-on until the first measurement has been made, and only when the measurement sample size is greater than one reading. It is described under the heading of 'Measurement Results' on *page 4-28*.

Measurement Definition

Functions

DC Voltage

Introduction

The 4950 is designed mainly for multifunction calibrators which are calibrated by storing corrections in non-volatile memory. The corrections are applied at two voltage points on each range: zero and nominal full range. The nominal full range points are at decade values $\pm 100\text{mV}$, $\pm 1\text{V}$, $\pm 10\text{V}$, $\pm 100\text{V}$ and $\pm 1\text{kV}$. Correcting the zero and full range points brings the ranges within specification.

The 4950 DC voltage ranges are the same as those of the calibrators, but instead of covering the full range spans, they consist of measurement bands at zero, positive full range and negative full range. Each band covers $\pm 10\%$ ($\pm 15\%$ on 100mV range) of the full range value at each of the calibration points. For instance on the 100V range the 4950 can measure from:

-10V to +10V (zero band);
+90V to +110V (positive full range band)
and -110V to -90V (negative full range band)

The other ranges conform to a similar pattern. For the majority of calibrators, these are also suitable target values.

To verify (but not correct) linearity for all its ranges, the 10V range on many calibrators is checked at $\pm 19\text{V}$. So for this purpose only, the 4950 10V range has an extra measurement band at 190% , which measures from $+18\text{V}$ to $+19.5\text{V}$ and from -19.5V to -18V .

For all the above bands, the 4950 will generate an error message on the main display if a signal is applied whose value falls outside the band limits.

DC Voltage Menu

DCV Ranges

At most times, the DC Voltage function can be selected and made active by pressing the front panel DCV key. This will open the DCV menu on the dot-matrix display:

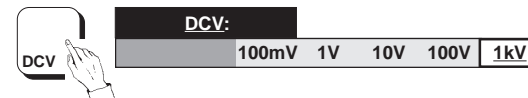

The 1kV range is the default range on power-up; this is shown by the cursor beneath the 1kV label. Any range can be selected by pressing the soft key under its range label. Each is a menu key, and opens a menu which allows selection from the valid measurement bands on that range.

For instance; pressing the 1kV menu key will open the 1KV range menu:



The 0% measurement band is the default for all ranges on power-up and reset; this is shown by the cursor beneath the 0% label. The 100% band can be selected by pressing its soft key.

To choose another range, press DCV again. Then, for instance, the 10V range can be selected by pressing the 10V menu key in the DCV menu (the extra 190% band also appears on the 10V range menu). The most-recently selected band is indicated by the cursor on the range menu.

When returning to the DCV menu, the most-recently selected range is indicated by the cursor.

DCV Config Key

DCV CONFIG Menu

At most times when in the DCV menu or one of the DCV range menus, the DCV CONFIG menu can be opened by pressing the front panel Config key. For example:

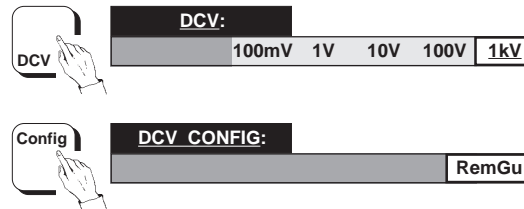

The DCV CONFIG menu gives a choice between Local or Remote Guard. The selection is then applied to all DCV ranges.

When Remote Guard *is not* selected, the input-socket Guard pin is open-circuited, and the internal guards connect to internal Lo (power-up and Reset default).

When Remote Guard is made active by pressing the RemGu soft key, the Lo connection is broken and the internal guards connect only to the input-socket Guard pin. It should be connected to a common-mode point in the external circuit. When active, a cursor appears on the DCV CONFIG menu beneath the RemGu label, and the RemG annunciator is lit on the main display.

The RemGu soft key has toggle action. By pressing it when active, Remote Guard is deselected. The connection reverts to Local Guard, the cursor is removed and the RemG annunciator disappears.

Error Messages

Measurement Band Limits

If a signal is input whose value is greater than the upper band limit, then the message 'Error OL' appears on the main display. Conversely, the message 'Error UL' appears for inputs less than the lower band limit.

Error Message Sense

The following diagram illustrates the meanings of Error UL and Error OL for relevant bands.

Negative		Zero		Positive	
Error OL		Error UL		Error OL	
- Full Range Band		Zero Band		+ Full Range Band	

Saved Selections

Exit from DCV Ranges

When exiting from a DCV range, by changing range or by transferring to another function, the measurement band in the range is saved. Subsequent re-entry to that range will re-activate the same band, regardless of selections in other ranges or functions.

Exit from DCV Function

When exiting from DCV (by transferring to another function) the DCV Range and Guard selection is saved. Subsequent re-entry to DCV will re-activate these parameters, regardless of selections in other functions.

Other illustrations (including a menu flow chart) are given in Section 3, pages 3-9 to 3-11.

Functions (Contd.)

AC Voltage

Introduction

The 4950 is designed mainly for multifunction calibrators which are calibrated by storing corrections in non-volatile memory. ACV corrections are generally applied at one voltage point on each range: nominal full range, at decade values 1mV, 10mV, 100mV, 1V, 10V, 100V and 1kV. Correcting the full range point brings the ranges within specification.

The 4950 AC voltage ranges match those of the calibrators, but instead of covering the full voltage span, they each consist of a single band, usually at nominal full range voltage, and generally extending to $\pm 10\%$ of nominal full range ($\pm 15\%$ on millivolt ranges). For instance on the 100V range the 4950 can measure from 90V to 110V. The other six ranges conform to a similar pattern. For a majority of calibrators, these are suitable target values.

To verify (but not correct) linearity for all its ranges, the 10VAC range on many calibrators is checked at 1kHz/19V. So for this purpose only, the 4950 10V range has an extra voltage band at 190%, measuring from 18V to 19.5V.

Frequency Bands

AC Voltage calibration is carried out at a series of frequencies across the spectrum of each range, correcting the calibrator's frequency response. The 4950 provides a corresponding set of frequency bands to measure a calibrator's output within $\pm 10\%$ of nominal frequencies ($\pm 15\%$ for 55Hz band, and from 270Hz to 440Hz for the 300Hz band), but to full specification only within $\pm 1\%$ of the frequency 'FCAL' at which the 4950 was last traceably calibrated (Certified Calibration). Refer to the following table:

Allocation of Frequency Bands to Ranges

Range	Frequency Band (Hz)															
	10	20	30	40	55 [‡]	300 [‡]	1k [†]	10k	20k	30k	50k	100k	200k	300k	500k	1M
1mV*	*	*	*	*	*→	←*	*	*	*→	←*	*	*		*→	←*	*
10mV*	*	*	*	*	*→	←*	*	*	*→	←*	*	*		*→	←*	*
100mV*	*	*	*	*	*→	←*	*	*	*→	←*	*	*		*→	←*	*
1V	*	*	*	*	*→	←*	*	*	*→	←*	*	*		*→	←*	*
10V	*	*	*	*	*→	←*	**	*	*→	←*	*	*		*→	←*	*
100V	*	*	*	*	*→	←*	*	*	*→	←*	*	*	*			
1kV	*	*	*	*	*→	←*	*	*	*→	←*	◆	◆				

- Notes: † The 1kHz frequency band is the ACV default for all ranges.
 ‡ The 55Hz frequency band is extended to cover both 50Hz and 60Hz.
 The 300Hz frequency band is extended to cover 400Hz.
 * For the millivolt ranges, all frequency bands: voltage measurement bands are $\pm 15\%$, not $\pm 10\%$.
 ◆ For the 1kV range, 50kHz and 100kHz frequency bands; voltage measurement bands are 700V, not 1kV.
 ** 10V range; 1kHz frequency band has extra voltage measurement band.
 → Menu soft key provided to transfer up to next higher frequency band menu.
 ← Menu soft key provided to transfer down to next lower frequency band menu.

AC Voltage and Frequency Band Menus

ACV Ranges

At most times, the AC Voltage function can be selected and made active by pressing the front panel ACV key. This will open the ACV menu on the dot-matrix display:

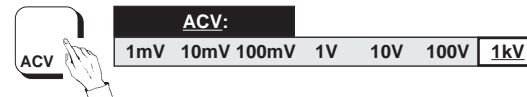

The 1kV range is the default range on power-up; this is shown by the cursor beneath the 1kV label. Any range can be selected by pressing the soft key under its range label. Each is a menu key, and opens a menu which allows selection from the valid frequency bands on that range.

For instance; pressing the 1kV menu key will open the 1KV range menu:



The 1kHz frequency band is the default for all ranges on power-up and reset; this is shown by the cursor beneath the 1kHz label. Another frequency band can be selected by pressing its soft key.

Because there are more frequency bands than can be represented on one menu, several (a maximum of four) menus are used for each voltage range. The <— soft key represents the highest frequency band on the next lower menu, and the —> soft key represents the lowest frequency band on the next higher menu. See the table opposite for the allocation of frequency bands to menus.

To choose another range, press ACV again. The most-recently selected range is indicated on the ACV menu by the cursor. Then, for instance, the 1V range can be selected by pressing the 1V menu key. The most-recently selected frequency band is indicated by the cursor on the 1V: Hz = menu.

No Voltage Band Menu Requirement

For ranges other than the 10V range, no voltage measurement band menu is implemented. Generally, only one voltage measurement band exists, but on 1kV range, when the frequencies 50kHz and 100kHz are selected, the menu title changes to '700V' (refer to pages 3-13 and 3-17).

10VAC Range -

190% Measurement Band at 1kHz

As mentioned earlier, a second (190%) voltage measurement band is allocated to the 1kHz frequency band on the 10V range, to verify a calibrators' range linearity only. Whenever this combination is selected the 10V: Hz = menu automatically transfers to the 10V: 1kHz menu:



This is a *voltage measurement* band menu, giving a choice between 100% and 190% bands. When opening, the selection always defaults to the 100% voltage band. The <-- and --> keys operate as in frequency band menus: either key exits back to the 10V: Hz = 300/1k/10k/20k menu, selecting 300Hz or 10kHz respectively.

Functions (Contd.)

ACV Config Key

ACV CONFIG Menu

At most times when in the ACV menu or one of the ACV range menus, the ACV CONFIG menu can be opened by pressing the front panel Config key. For example:

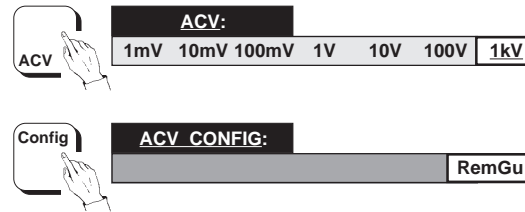

The ACV CONFIG menu gives a choice between Local or Remote Guard. The selection is then applied to all ACV ranges.

When Remote Guard *is not* selected, the input-socket Guard pin is open-circuited, and the internal guards connect to internal Lo (power-up and Reset default).

When Remote Guard is made active by pressing the RemGu soft key, the Lo connection is broken and the internal guards connect only to the input-socket Guard pin. It should be connected to a common-mode point in the external circuit. When active, a cursor appears on the ACV CONFIG menu beneath the RemGu label, and the RemG annunciator is lit on the main display.

The RemGu soft key has toggle action. By pressing it when active, Remote Guard is deselected. The connection reverts to Local Guard, the cursor is removed and the RemG annunciator disappears.

Error Messages

Frequency Band Limits

If a signal is input whose frequency is higher than the upper band-limit, then the message 'Error HF' appears on the main display. Conversely, the message 'Error LF' appears for input frequencies below the lower band-limit.

Voltage Measurement Band Limits

If a signal is input whose voltage is greater than the upper band-limit, then the message 'Error OL' appears on the main display. Similarly, the message 'Error UL' appears for input voltages less than the lower band-limit.

Saved Selections

Exit from ACV Ranges

When exiting from an ACV range, by changing range or by selecting another function, the frequency band in the range is saved. Subsequent re-entry will re-activate the same band, regardless of selections in other ranges or functions.

Exit from ACV Function

When exiting from ACV (by transferring to another function) the ACV Range and Guard selection is saved. Subsequent re-entry to ACV will re-activate these parameters, regardless of selections in other functions.

Other illustrations (including a menu flow chart) are given in Section 3, pages 3-12 to 3-19.

Ohms

Introduction

The 4950 is designed mainly for multifunction calibrators which are calibrated by storing resistance values in non-volatile memory. The corrections to the values are usually applied at two resistance points on each range: zero and nominal. Nominal values are in decades: 10 Ω , 100 Ω , 1k, 10k, 100k 1M, 10M and 100M. Correcting the zero and nominal values provides a readout within specification.

The 4950 Ohms ranges align to those of many calibrators. They consist of measurement bands at zero and three other values. Each band covers $\pm 10\%$ of full range either side of a nominal value (except the upper limit of the 190% band: +5%). e.g. on the 100 Ω range the band limits are:

0% band: Zero to +10 Ω ; 0 to +10% FR
 30% band: 20 Ω to 40 Ω ; $\pm 10\%$ FR
 100% band: 90 Ω to 110 Ω ; $\pm 10\%$ FR
 190% band: 180 Ω to 195 Ω . -10%, +5% FR

There is no 190% band on the 100M Ω range. With this exception, the other seven ranges conform to a similar pattern.

Some calibrators include a 1 Ω resistance value; so the 4950 10 Ω range has an extra (10%) band at 1 Ω , which measures from 0.9 Ω to 1.1 Ω .

The 4950 will generate an error message on the main display if the value of a connected resistance falls outside the limits of the selected band.

The 4950 is normally configured for 4-wire Ohms measurements, but during calibration, the input lead may be characterized for two-wire Ohms.

Ohms Menu

Ohms Ranges

At most times, the Ohms function can be selected and made active by pressing the front panel Ohms key. This will open the OHMS menu on the dot-matrix display:

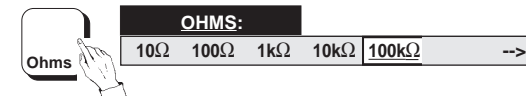

The 100k Ω range is the default range on power-up; this is shown by the cursor beneath the 100k Ω label. Any range can be selected by pressing the soft key under its range label. Each is a menu key, and opens a menu which allows selection from the valid measurement bands on that range.

For instance; pressing the 1k Ω menu key will open the 1k Ω range menu:



The 0% measurement band is the default for all ranges on power-up and reset; this is shown by the cursor beneath the 0% label. Another band can be selected by pressing its soft key.

To choose another range, press Ohms again.

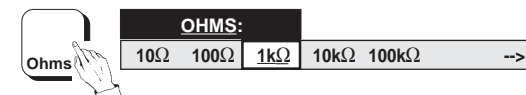

Functions (Contd.)

Ohms Menu (Contd.)

Ohms Band Menus

Because there are more bands than can be represented on one menu, two menus are used for each Ohms range. The --> soft key in the low Ohms menu represents the lowest band (1MΩ) on the high Ohms menu. Pressing this key transfers to the high Ohms menu:



In the high Ohms menu, the<-- soft key represents the highest band (100kΩ) on the low Ohms menu.

The 10Ω range can be selected by pressing the <- key then the 10Ω menu key (the extra 10% band also appears on the 10Ω range menu). The most-recently selected band is indicated by the cursor on the range menu.



When opening a range menu, the most-recently selected *band* is indicated by the cursor. When returning to the OHMS menu by pressing the Ohms key, the cursor indicates the most-recently selected *range*.



Ohms Config Key

OHMS CONFIG Menu

At most times when in the Ohms menu or one of the Ohms range menus, the OHMS CONFIG menu can be opened by pressing the front panel Config key. For example:

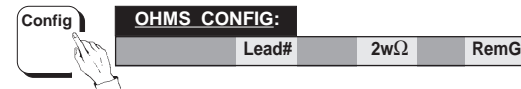
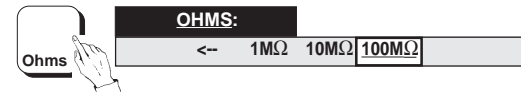

4-Wire Ohms

4-wire Ohms is the default state when first using Ohms function after power-on, as indicated by the main display 4wΩ annunciator being lit when Ohms is active. This state continues until 2-wire Ohms is selected in the OHMS CONFIG menu.

2-Wire Ohms

If the characterized lead serial number has already been entered, then 2-wire Ohms can be selected by pressing the 2wΩ soft key. Unless the Hi and Lo wires of the correct lead are employed when using the 2-wire Ohms facility, the measurements will not be traceable. As a constraint when first selecting 2-wire ohms after power on, the characterized lead serial number must be entered. Otherwise 2wΩ cannot be selected and an error message will appear on the dot-matrix display:

1032 : 2wΩ selection requires lead#

2-Wire Ohms Lead Serial Number

The serial number of the characterized 2-wire Ohms lead is marked on the lead itself. The number can also be found by pressing the front panel **Status** key, followed by the **Config** key. This opens the STATUS CONFIG menu on the dot-matrix display. Then pressing the **Lead** key shows the lead serial number (Refer to *page 4-5*).

Lead#

The **Lead#** soft key in the OHMS CONFIG menu opens the LEAD SER # = menu.

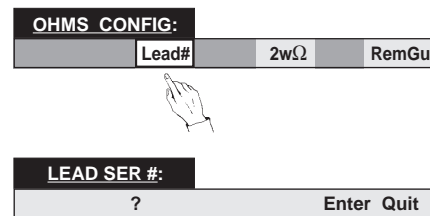

Then the characterized lead serial number can be entered using the numeric keyboard keys, which are activated for this menu field. Neither the lead serial number nor its characterized resistance can be changed in this presentation. The lead's serial number is recorded by a specific operation in Calibration mode, which also measures the series resistance of its Hi and Lo wires. When subsequently used in 2-wire Ω mode, this series lead resistance value is subtracted from the total measured resistance value to compensate for resistance of the lead.

When the correct number has been written in, pressing the **Enter** soft key registers the serial number, and the dot-matrix display reverts to the OHMS CONFIG menu. Pressing the **Quit** soft key also reverts to the OHMS CONFIG menu, with no change.

If an incorrect number was written and entered, then an error message will appear on the dot-matrix display:

1033 : lead serial number incorrect

To escape, press the **Ohms** key, then the **Config** key. The 4950 ignores the incorrect serial number and permits another attempt.

2w Ω Key

Once the correct lead serial number has been accepted, it remains so until the 4950 is powered down or reset. After acceptance, pressing the **2w Ω** soft key in the OHMS CONFIG menu will connect the input for 2-wire Ohms (Hi and Lo wires), a cursor will appear beneath the **2w Ω** label, and the main display **4w Ω** annunciator will be extinguished.

Reversion to 4-wire Ohms

Merely press the **2w Ω** soft key again (cursor present). The 4950 will connect its input for 4-wire Ohms, the cursor beneath the **2w Ω** label will be removed, and the main display **4w Ω** annunciator will reappear.

Functions (Contd.)

Ohms Config Key

OHMS CONFIG Menu (Contd.)

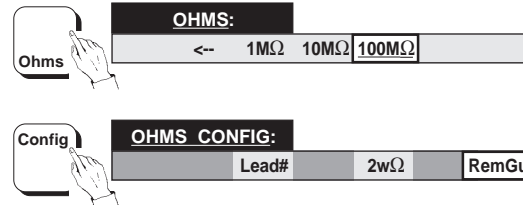

Remote Guard

The OHMS CONFIG menu offers a choice between Local or Remote Guard. The selection is then applied to all Ohms ranges.

In Ohms function only, the Lo pin on the input socket is not connected to the internal analog common (as for other functions), but made active as the Ohms low sense connection. The internal guard screens and tracks are permanently connected to analog common (power-up and Reset default).

When Remote Guard is made active by pressing the RemGu soft key, the internal guards also connect to the input-socket Guard pin, for connection to a common-mode point in the external circuit. It should be connected to a common-mode point in the external circuit. When active, a cursor appears on the OHMS CONFIG menu beneath the RemGu label, and the RemG annunciator is lit on the main display. When Remote Guard *is not* selected, the input-socket Guard pin is open-circuited.

The RemGu soft key has toggle action. By pressing it when active, Remote Guard is deselected. The connection reverts to Local Guard, the cursor is removed and the RemG annunciator disappears.

Error Messages

Measurement Band Limits

If resistance is connected whose value is greater than the upper band-limit, then the message 'Error OL' appears on the main display. Conversely, the message 'Error UL' appears for resistor values less than the lower band limit.

Saved Selections

Exit from Ohms Ranges

When exiting from an Ohms range, by changing range or by transferring to another function, the measurement band in the range is saved. Subsequent re-entry to that range will re-activate the same band, regardless of selections in other ranges or functions.

Exit from Ohms Function

When exiting from Ohms (by transferring to another function) the Ohms Range, 2/4-wire Ω and Guard selection is saved. Subsequent re-entry to Ohms will re-activate these parameters, regardless of selections in other functions.

Other illustrations (including a menu flow chart) are given in Section 3, pages 3-20 to 3-25.

DC Current

Introduction

The 4950 is designed mainly for multifunction calibrators which are calibrated by storing corrections in non-volatile memory. The corrections are applied at two current points on each range: zero and nominal full range. The nominal full range points are at decade values $\pm 100\mu\text{A}$, $\pm 1\text{mA}$, $\pm 10\text{mA}$, $\pm 100\text{mA}$, $\pm 1\text{A}$ and $\pm 10\text{A}$. Correcting the zero and full range points brings the ranges within specification.

The 4950 DC current ranges are the same as those of the calibrators, but instead of covering the full range spans, they consist of measurement bands at zero, positive full range and negative full range. Each band covers $\pm 10\%$ of the full range value at each of the calibration points. For instance on the 100mA range the 4950 can measure from:

-10mA to +10mA (zero band);
+90mA to +110mA (positive full range band)
and -110mA to -90mA (negative full range band)

The other five ranges conform to a similar pattern. For the majority of calibrators, these are also suitable target values.

The 4950 10A range requires a 10A shunt, designated during the most-recent DCI calibration. Unless that particular shunt is used, the 10A range will not be traceable. The 10A range cannot be used until the correct shunt serial number has been registered via the DCI CONFIG menu.

For the above bands, the 4950 will generate an error message on the main display if a signal is applied whose value falls outside the band limits.

DC Current Menu

DCI Ranges

At most times, the DC Current function can be selected and made active by pressing the front panel DCI key. This will open the DCI menu on the dot-matrix display:

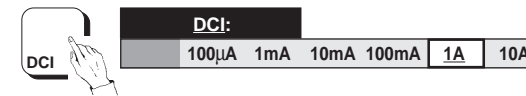

The 1A range is the default range on power-up; this is shown by the cursor beneath the 1A label. Any range can be selected by pressing the soft key under its range label. Each is a menu key, and opens a menu which allows selection from the valid measurement bands on that range.

For instance; pressing the 1A menu key will open the 1A range menu:



The 0% measurement band is the default for all ranges on power-up and reset; this is shown by the cursor beneath the 0% label. The 100% band can be selected by pressing its soft key.

To choose another range, press DCI again. Then, for instance, the 10mA range can be selected by pressing the 10mA menu key in the DCI menu. The most-recently selected band is indicated by the cursor on the range menu.

When returning to the DCI menu, the most-recently selected range is indicated by the cursor.

Functions (Contd.)

DC Current Menu (Contd.)

DCI 10A Range

If the designated shunt serial number has already been entered, then the 10A range can be selected by pressing the 10A soft key in the DCI menu. Unless the correct shunt is employed, the measurements will not be traceable. As a constraint when first selecting the 10A range after power on, the designated shunt serial number must be entered via the DCI CONFIG or ACI CONFIG menu. Otherwise 10A cannot be selected and an error message will appear on the dot-matrix display:

1028 : 10A selection requires shunt #

10A Shunt Serial Number

The serial number of the designated 10A shunt is marked on the shunt itself. The number can also be found by pressing the front panel **Status** key, followed by the **Config** key. This opens the STATUS CONFIG menu on the dot-matrix display (overleaf). Then pressing the soft **Shunt** key shows the shunt serial number (Refer to *page 4-5*).

DCI Config Key

DCI CONFIG Menu

At most times when in the DCI menu or one of the DCI range menus, the DCI CONFIG menu can be opened by pressing the front panel **Config** key. For example:



Shunt#

The **Shunt#** soft key in this menu opens the 10A SHUNT SER # = menu.



Then the designated shunt serial number can be entered using the numeric keyboard keys, which are activated for this menu field. The shunt serial number cannot be changed in this presentation. It can only be altered during a specific operation when in Calibration mode.

When the correct number has been written in, pressing the **Enter** soft key registers the serial number, and the dot-matrix display reverts to the DCI CONFIG menu. Pressing the **Quit** soft key also reverts to the DCI CONFIG menu, with no change.

If an incorrect number was written and entered, then an error message will appear on the dot-matrix display:

```
1027 : shunt serial number incorrect
```

To escape, press the DCI key then the Config key. The 4950 ignores the incorrect serial number and permits another attempt.

DCI 10A Key

Once the correct shunt serial number has been accepted, it remains so until the 4950 is powered down or reset. After acceptance, pressing the 10A soft key in the DCI menu will open the 10A range menu.

Local/Remote Guard

The DCI CONFIG menu gives a choice between Local or Remote Guard. The selection is then applied to all DCI ranges.

```
DCI CONFIG:
```

```
Shunt#
```

```
RemGu
```

When Remote Guard *is not* selected, the input-socket Guard pin is open-circuited, and the internal guards connect to internal Lo (power-up and Reset default).

When Remote Guard is made active by pressing the RemGu soft key, the Lo connection is broken and the internal guards connect only to the input-socket Guard pin. It should be connected to a common-mode point in the external circuit. When active, a cursor appears on the DCI CONFIG menu beneath the RemGu label, and the RemG annunciator is lit on the main display.

The RemGu soft key has toggle action. By pressing it when active, Remote Guard is deselected. The connection reverts to Local Guard, the cursor is removed and the RemG annunciator disappears.

Functions (Contd.)

Error Messages

Measurement Band Limits

If a signal is input whose value is greater than the upper band limit, then the message 'Error OL' appears on the main display. Conversely, the message 'Error UL' appears for inputs less than the lower band limit.

Error Message Sense

The following diagram illustrates the meanings of Error UL and Error OL for relevant bands.

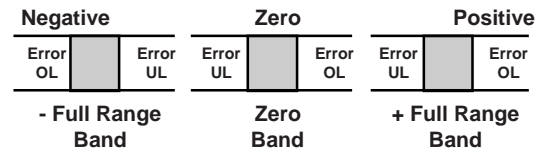

Saved Selections

Exit from DCI Ranges

When exiting from a DCI range, by changing range or by transferring to another function, the measurement band in the range is saved. Subsequent re-entry to that range will re-activate the same band, regardless of selections in other ranges or functions.

Exit from DCI Function

When exiting from DCI (by transferring to another function) the DCI Range and Guard selection is saved. Subsequent re-entry to DCI will re-activate these parameters, regardless of selections in other functions.

Other illustrations (including a menu flow chart) are given in Section 3, pages 3-26 to 3-31.

AC Current

Introduction

The 4950 is designed mainly for multifunction calibrators which are calibrated by storing corrections in non-volatile memory. The corrections are applied at a single current point on each range: nominal full range. The nominal full range points are at decade values 100µA, 1mA, 10mA, 100mA, 1A and 10A. Correcting the full range points brings the ranges within specification.

The 4950 AC current ranges match those of the calibrators, but instead of covering the full range spans, they consist of a single measurement band: full range. The band covers ±10% of the full range value. For instance on the 100mA range the 4950 can measure from:

90mA to 110mA RMS

The other five ranges conform to a similar pattern. For the majority of calibrators, these are also suitable target values.

Frequency Bands

Because ACI is defined in frequency as well as current value, an extra layer of menus is needed for selection.

Frequency Bands

AC Current calibration is carried out at a series of frequencies across the spectrum of each range, correcting the calibrator's frequency response. The 4950 provides a corresponding set of frequency bands to measure a calibrator's output within $\pm 10\%$ of nominal frequencies ($\pm 15\%$ for 55Hz band and from 270Hz to 440Hz for the 300Hz band), but to full specification only within $\pm 1\%$ of the frequency 'FCAL' at which the 4950 was last traceably calibrated (Certified Calibration). Other than the 20kHz band (10A range only), all bands are present on each range. Refer to the table below.

Frequency Band Selection

Most frequency bands are available on every AC Current range, but not all. The table shows the allocation of frequency bands to ranges; only the starred combinations are available.

The 4950 10A range requires an external 10A shunt, designated during the most-recent ACI calibration. Unless that particular shunt is used, the 10A range is not traceable. The 10A range cannot be used until the correct shunt serial number has been entered via the ACI or DCI CONFIG menu.

For the above bands, the 4950 will generate an error message on the main display if a signal is applied whose value falls outside the band limits.

Allocation of Frequency Bands to Ranges

Range	Frequency Band (Hz)										
	10	20	30	40	55 §	300* §	1k	5k	10k	20k	30k
100µA	*	*	*	*	*→	←*	*	*	*→	←*	*
1mA	*	*	*	*	*→	←*	*	*	*→	←*	*
10mA	*	*	*	*	*→	←*	*	*	*→	←*	*
100mA	*	*	*	*	*→	←*	*	*	*→	←*	*
1A†	*	*	*	*	*→	←*	*	*	*→	←*	*
10A‡	*	*	*	*	*→	←*	*	*	*	*	*

Notes:

- † 1A is the ACI default range.
- ◆ The 300Hz frequency band is the ACI default for all ranges.
- § The 55Hz frequency band is extended to cover both 50Hz and 60Hz.
The 300Hz frequency band is extended to cover 400Hz.
- Menu soft key provided to transfer up to the high frequency band menu.
- ← Menu soft key provided to transfer down to the low frequency band menu.
- ‡ Selection of ACI 10A range requires the correct shunt serial number to have been entered in the SHUNT# menu.

Functions (Contd.)

AC Current Menu (Contd.)

ACI Ranges

At most times, the AC Current function can be selected and made active by pressing the front panel ACI key. This will open the ACI menu on the dot-matrix display:

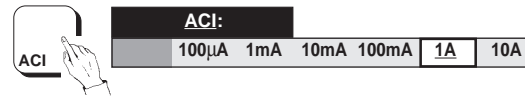

The 1A range is the default range on power-up; this is shown by the cursor beneath the 1A label. Any range can be selected by pressing the soft key under its range label. Each range key is a menu key, but there are no ACI measurement band menus, as only one band exists on each range. Instead, each range key opens a menu for selection from the valid frequency bands on that range.

For instance; pressing the 1A menu key will open the 1A: Hz = menu:



The 300Hz frequency band is the default for all ranges on power-up and reset; this is shown by the cursor beneath the 300 label. Other frequency bands can be selected by pressing their soft keys.

Because there are more frequency bands than can be represented on one menu, two menus are used for each current range. The <-- soft key represents the 55Hz band in the LF band menu, giving:



To choose another range, press ACI again. The most-recently selected range is indicated on the ACI menu by the cursor. Then, for instance, the 10mA range can be selected by pressing the 10mA menu key in the ACI menu.

The most-recently selected *frequency band* is indicated by the cursor on the range menu.

When returning to the ACI menu, the most-recently selected *range* is indicated by the cursor.

ACI 10A Range

If the designated shunt serial number has already been entered, then the 10A range can be selected by pressing the 10A soft key in the ACI menu. Unless the correct shunt is employed, the measurements will not be traceable. As a constraint, when first selecting the 10A range after power on, the designated shunt serial number must be entered via the ACI CONFIG or DCI CONFIG menu. Otherwise 10A cannot be selected and an error message will appear on the dot-matrix display:

1028 : 10A selection requires shunt #

10A Shunt Serial Number

The serial number of the designated 10A shunt is marked on the shunt itself. The number can also be found by pressing the front panel Status key, followed by the Config key. This opens the STATUS CONFIG menu on the dot-matrix display (overleaf). Then pressing the soft Shunt key shows the shunt serial number (Refer to *page 4-5*).

ACI Config Key

ACI CONFIG Menu

At most times when in the ACI menu or one of the ACI range menus, the ACI CONFIG menu can be opened by pressing the front panel Config key. For example:

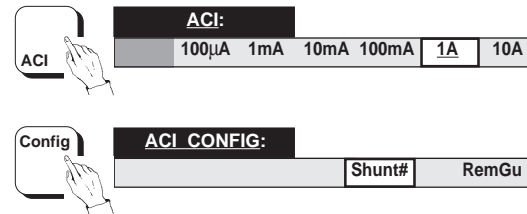

Shunt#

The Shunt# soft key in this menu opens the 10A SHUNT SER # = menu.



Then the designated shunt serial number can be entered using the numeric keyboard keys, which are activated for this menu field. The shunt serial number cannot be changed in this presentation. It can only be altered during a specific operation when in Calibration mode.

When the correct number has been written in, pressing the Enter soft key registers the serial number, and the dot-matrix display reverts to the ACI CONFIG menu. Pressing the Quit soft key also reverts to the ACI CONFIG menu, with no change.

If an incorrect number was written and entered, then an error message will appear on the dot-matrix display:

1027 : shunt serial number incorrect

To escape, press the ACI key, then the Config key. The 4950 ignores the incorrect serial number and permits another attempt.

ACI 10A Key

Once the correct shunt serial number has been accepted, it remains so until the 4950 is powered down or reset. After acceptance, pressing the 10A soft key in the ACI menu will open the 10A range menu.

Functions (Contd.)**ACI Config Key** (Contd.)**Local/Remote Guard**

The ACI CONFIG menu gives a choice between Local or Remote Guard. The selection is then applied to all ACI ranges.



When Remote Guard *is not* selected, the input-socket Guard pin is open-circuited, and the internal guards connect to internal Lo (power-up and Reset default).

When Remote Guard is made active by pressing the RemGu soft key, the Lo connection is broken and the internal guards connect only to the input-socket Guard pin. It should be connected to a common-mode point in the external circuit. When active, a cursor appears on the ACI CONFIG menu beneath the RemGu label, and the RemG annunciator is lit on the main display.

The RemGu soft key has toggle action. By pressing it when active, Remote Guard is deselected. The connection reverts to Local Guard, the cursor is removed and the RemG annunciator disappears.

Error Messages**Current Measurement Band Limits**

If a signal is input whose AC current value is greater than the upper measurement band-limit, then the message 'Error OL' appears on the main display. Conversely, the message 'Error UL' appears for inputs less than the lower band-limit.

If a signal is input whose frequency is higher than the upper frequency band-limit, then the message 'Error HF' appears on the main display. Conversely, the message 'Error LF' appears for input frequencies below the lower band-limit.

Saved Selections**Exit from ACI Ranges**

When exiting from a ACI range, by changing range or by transferring to another function, the frequency band in the range is saved. Subsequent re-entry to that range will re-activate the same band, regardless of selections in other ranges or functions.

Exit from ACI Function

When exiting from ACI (by transferring to another function) the ACI Range and Guard selection is saved. Subsequent re-entry to ACI will re-activate these parameters, regardless of selections in other functions.

Other illustrations (including a menu flow chart) are given in Section 3, pages 3-32 to 3-38.

Measurement Parameters

Mode Key and Menu

The front panel Mode key gives access to a menu which permits Accuracy and Band Limits parameters to be altered:



MODE: LoAcc HiAcc BAND LMT: On Off

Accuracy Mode

Introduction

The 4950 has two levels of accuracy: high and low, each with its own specification. Switching between the two is achieved using the front panel Mode key.

High Accuracy Mode

High accuracy measurement mode offers the full instrument specification, with high resolution (see the table below). When making *mechanical* adjustments to a unit under test, however, processing the fewer internal samples required in low accuracy mode may be more convenient. *Ultimately, though, High Accuracy mode will be required for final adjustments to obtain full traceability.*

Low Accuracy Mode

The low accuracy mode increases the operating speed by using fewer internal samples. The mean presented on the display will be of greater uncertainty than in high accuracy mode, but this mode can speed mechanical adjustments.

Accuracy Mode Selections

High accuracy is the default mode on power-up; this is shown by the cursor beneath the HiAcc label. Low accuracy can be selected by pressing the soft key under the LoAcc label. Each key operates immediately, cancelling the present measurement, switching to the selected mode and waiting for the next trigger.

Exit from the menu by pressing any other hard menu key. The table below shows the specific effects on the instrument's functions and ranges.

Funct.	Range	Sample Size (internal readings)		Resolution (digits)	
		Low Acc.	High Acc.	Low Acc.	High Acc.
DCV	100mV	4	128	6.5	7.5
	1V-1000V	4	64	6.5	7.5
ACV	1mV	1	8	4.5	5.5
	10mV-1000V	1	8	5.5	6.5
Ohms	10Ω	4	128	6.5	7.5
	100Ω - 1MΩ	4	64	6.5	7.5
	10MΩ & 100MΩ	4	128	6.5	7.5
DCI	100μA-10A	1	32	5.5	6.5
ACI	100μA-10A	1	8	5.5	6.5

Band Limit

Introduction

The high levels of accuracy of the 4950 are specified for measurements (Voltage, Current, Resistance, Frequency, etc.) made within the limits of narrow bands (around $\pm 10\%$ of full range), about certain 'nominal' points. These points are set, in firmware, to coincide with output levels (and frequencies) required to calibrate common types of calibrators.

At times it may be necessary to measure outside the set band limits, and so a facility has been incorporated to turn them off:

BAND LMT: On

This is the default state. The measurement capability is confined to set band limits, described for each Function earlier in this section. Measurements made outside these limits will show an error message.

The specifications in Section 6 apply to measurements in these bands, made in 'High Accuracy' mode.

BAND LMT: Off

This should be used with extreme caution. The 4950 will measure outside its band limits without showing an error message.

Measurement Definition (Contd.)

Measurement Parameters (Contd.)

Certified and Baseline Corrections

Introduction

In one role, the measurement transfer involves checking a calibrator twice against a 4950 whose accuracy is governed by corrections stored at its baseline (initial) calibration. It also involves calibrating the calibrator by the same 4950 whose accuracy was determined at its most recent certified (traceable) calibration.

In an alternative role, the 4950's drift is measured against the 'Hub' calibration standard before and after its journey around the calibration loop. For this purpose the baseline corrections are applied. When calibrating remote calibrators the certified corrections are applied.

Switching between certified and baseline corrections is achieved using the front panel Cert key.

Cert Key and Menu

The corrections are changed by pressing the front panel Cert key, opening the CERTIFIED CORRNS menu:

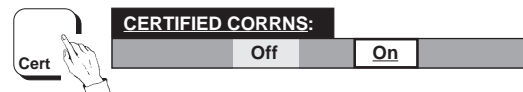

Certified Corrections

Certified corrections are those which have recently been updated to provide the traceability to 'Hub' standards. The selection, indicated by the cursor beneath the On label, applies the certified corrections to subsequent measurements.

Baseline Corrections

When the cursor is beneath the Off label, the baseline corrections, obtained at manufacture, are applied to measurements.

Power-on Default

The power-on default is On. The required corrections are selected by pressing the soft key under the appropriate label.

Exit from the menu by pressing any other hard menu key.

Calibration Mode

On entry to calibration mode the 'on' state is enforced for normal calibration. Exit from cal mode will not modify the last-selected state. While in cal mode the front panel Cert key is de-activated.

Measurement Results

Type of Measurement, Quality and Frequency

Type of Measurement

Main Display

Internal Samples

For each measurement a number of individual readings is taken in an internal sample. The sample size has been optimized for the selected function/range/accuracy combination, and so is not user-selectable. The value presented on the Main (left-hand) display is the calculated arithmetic mean of the sample. For samples containing only one reading, the value of that reading is taken as the mean (refer to the table on *Page 4-25*).

Measurement Bands and Frequency Bands

The measurement results which appear on the main display are constrained to 'measurement bands' within the ranges of the selected functions. For ACV and ACI functions, the results are also constrained to bands of frequency.

Error Messages on the Main Display

If a signal is applied whose value falls outside measurement or frequency band limits, an error message will appear on the main display:

Measurement Bands: Error OL; Error UL.

Frequency Bands: Error HF; Error LF.

References

Measurement and frequency bands, together with their distribution, limits and error messages, are described earlier in this section under the main heading of 'Measurement Definition - Functions', from *page 4-8* to *page 4-24*.

Legends and Annunciators

The main display also has legends to indicate the type of quantity being measured, and annunciators to remind users of the current status conditions. These are:

4wΩ	4-wire Ohms connection has been selected and is active.
RemG	Remote Guard connection has been selected and is active.
Ext	Triggers from an external source are required.
Spcl	Baseline Calibration is selected and active (Manufacturer only).
SRQ	The SRQ bit has been set by <i>this</i> instrument for any reason governed by the status reporting system, including the front panel SRQ key.
Rem	The instrument is operating under remote control via the IEEE 488 interface.
Busy	A lengthy internal process is under way. Any key-press will abort this process.
Cal	Calibration mode is selected and active.

Measurement Quality

Monitor Key

The Measurement Quality of the most-recently completed sample of readings can be obtained by first pressing the front panel Monitor key, then the soft Qual key in the MONITOR menu.. This will open the QUALITY menu on the dot-matrix display:

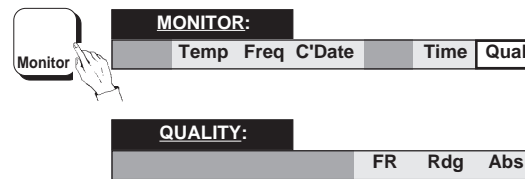

This menu gives a choice of units. To obtain the Quality in terms of:

ppm of nominal full range: press FR;
 ppm of the reading: press Rdg;
 values of the selected function: press Abs.

Pressing either of the three soft keys presents the QUALITY display. The quality figure (SIGMA) is produced by calculating the standard error of the mean of the sample of internal readings:

```

QUALITY:
SIGMA = XXXXXXXX  SAMPLE = XXX
  
```

The units appended to the figures following 'SIGMA =' reflect the choice made in the previous QUALITY menu.

The figures following 'SAMPLE =' give the number of internal readings which comprise the most-recently completed measurement sample.

Availability of Results

The result of each successive calculation is stored, overwriting the result from the previous sample, and remaining in store until overwritten by the result from the next sample. The store contents are read onto the QUALITY display (whenever it is selected), which also changes as the store is updated.

Quality Measurement Unavailable

The words NOT AVAILABLE will appear in place of the result on the QUALITY display; under the following conditions:

- The measured value of the signal is not within the measurement band limits. Error OL or Error UL will also appear on the Main display.
- **ACV, DCI or ACI only:**
The 4950 is in low accuracy mode with ACV, DCI or ACI function selected, (only one reading per sample). In these cases the quality value would be meaningless, and so the Main display remains blank.
- **ACV and ACI only:**
The measured *frequency* result is not within the *frequency* band limits. Error HF or Error LF will also appear on the Main display.

Power On and Reset Conditions:

As all previous results are cleared at Power On and Reset, a quality result cannot exist until the first measurement sample has been completed. Until a result is available, 'NOT AVAILABLE' is shown on the QUALITY display.

Signal Frequency (ACV & ACI only)

Monitor Key

The 4950 measures the frequency of the input for each sample (ACV and ACI only). A readout can be obtained by first pressing the front panel Monitor key; then pressing the soft Freq key in the MONITOR menu. The result will appear on the SIGNAL FREQUENCY display on completion of the next measurement sample:

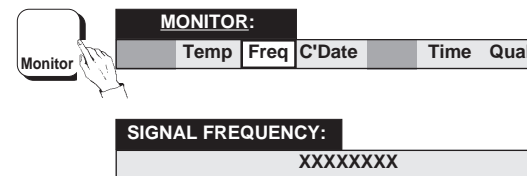

The signal frequency is given in Hz.

If the 4950 is not in either ACV or ACI, the following error message will be given in place of the frequency result:

1008 Must be in AC function

Availability of Results

Each result is stored, overwriting the result from the previous sample, and remaining in store until overwritten by the result from the next sample.

On completion of each measurement sample, the store contents will be read onto the SIGNAL FREQUENCY display, which also changes as the store is updated.

Frequency Measurement Unavailable

The words NOT AVAILABLE will appear in place of the frequency result; under the following conditions:

- The frequency measurement does not produce a displayable result.
- The *frequency* result is not within the *frequency* band limits. Error HF or Error LF will also appear on the Main display.
- The *measured* value of the signal is not within the *measurement* band limits. Error OL or Error UL will also appear on the Main display.

Power On and Reset Conditions

As all previous results are cleared at Power On and Reset, a signal frequency result cannot exist until the first measurement sample has been completed. Until a result is available, 'NOT AVAILABLE' is shown on the SIGNAL FREQUENCY display.

Selftest Operations

Display Test — Keyboard Test — Confidence Test

'Test' Key

All selftest programs are initiated from within the TEST menu, which is opened by pressing the front panel Test key. An overview of all the test menus is given on *Page 4-32*.



Display Test — 'Disp' soft key

A reminder menu appears first, noting the actions of the front panel keys:

ANY KEY : CONTINUE TEST KEY : EXIT

Repeatedly pressing any key **other** than the 'Test' key increments both displays through a sequence of 'walking strobos', which allow a user to inspect individual segments and complete blocks.

Confidence Test — 'Conf' soft key

Introduction

This is an automatic sequence of internal performance tests, presenting a continuing progress report on the dot-matrix display, until either the test is completed or is halted by an unsuccessful result.

Starting the Confidence Test

N.B. For the confidence test the input connector must be removed.

The confidence test is started by pressing the soft Conf soft key in the TEST menu:



Keyboard Test — 'Key' soft key

The Key soft key presents the KEYBOARD TEST menu.



All keys **other** than the Test key can be tested by pressing. For each key pressed, the 'Key #' is followed by the key's hexadecimal matrix position, then after a colon an 'S' is followed by the key's switch ident number. The name of the key is given on the right of the display.

Exit

During 'Disp' or 'Key' checks, pressing the Test key **terminates the sequence** (and incidentally checks the Test key).

The automatic sequence begins, and a message appears on the dot-matrix display:

CONFIDENCE TEST RUNNING

As the confidence test proceeds, a short description of each test is presented on the TEST display:



The description changes as the sequence moves from one test to the next.

Confidence Test (Contd.)

Unsuccessful Test

If the results of a test fall outside internally-imposed limits, the sequence halts. The dot-matrix display describes the unsuccessful test, and a soft key is nominated for continuance:

2XXX:	
Description of test	Cont

Each test failure has its own four-digit code number, beginning with the figure '2', which replaces the word TEST as the menu title. A list of codes is given in Appendix A at the end of this section.

After noting the code, pressing the **Cont** soft key will re-start the confidence test from the point in the sequence at which it halted. Whenever a test is unsuccessful, a report is given, and then the test can be continued by pressing the **Cont** key.

N.B.

When the test of any of the following parameters is unsuccessful, the relevant code may be accompanied by a further qualification:

- a. Main Reference drift,
- b. A-D Positive ± 16 reference drift,
- c. A-D Negative ± 16 reference drift, or
- d. Reference Ratio drift

The qualifying message will result from a check of the 4950 status to determine whether any of the following conditions apply:

- Is the instrument still within its 6 hour warm up period?
- Is the internal temperature outside $\pm 3^{\circ}\text{C}$ of that at certified calibration?
- Has 30 days expired since the most-recent certified calibration?

If any of these conditions apply, then an appropriate comment is displayed, together with the relevant code number.

Refer to *Section 4, Appendix A*.

Confidence Test Completion

When the Confidence test has finally run to its conclusion, whether or not it was all successful, the following message will appear on the dot-matrix display:

CONFIDENCE TEST COMPLETED

Press any main function key to escape.

Selftest Operations (Contd.)

Test Menu

Movement among the TEST group of menus is described by the following diagram:

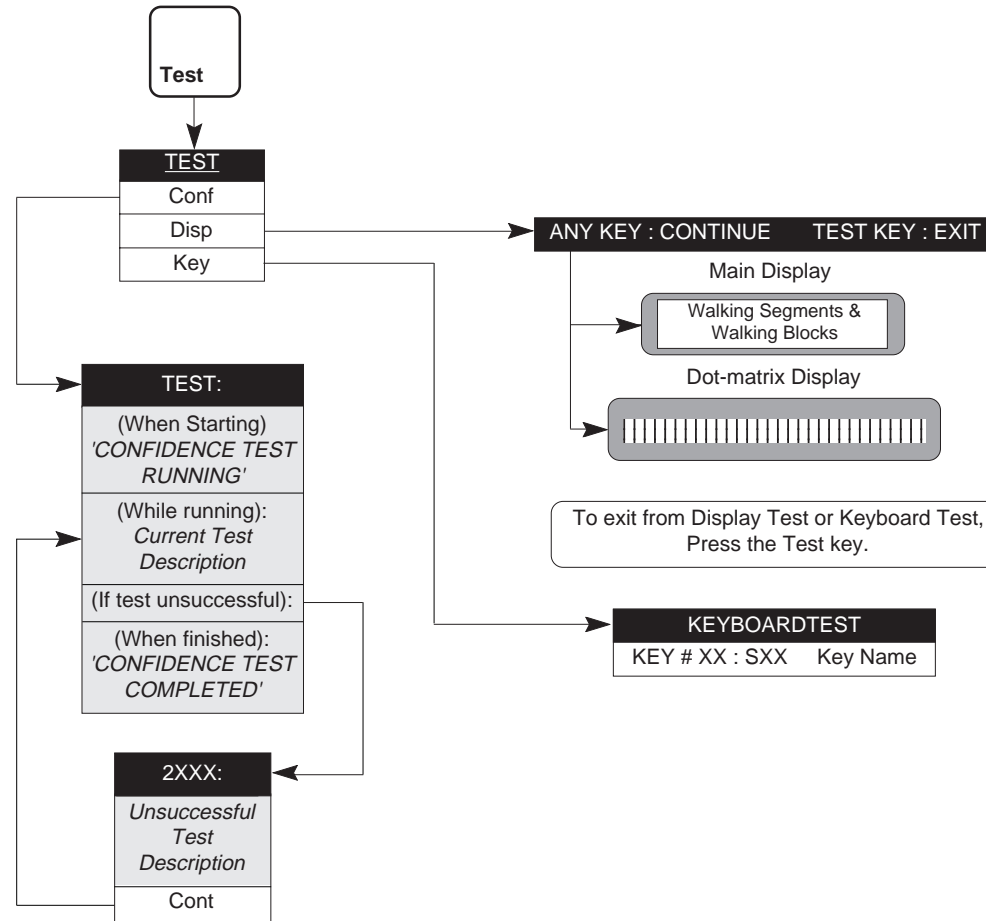

Direct Action Keys

Reset - Ext' Trig - Sample - Local - SRQ - Caltrig - Zero

Reset

The Reset key provides a quick means of restoring the 4950 to the default states. These are shown on *Page 3-6*.

Some settings associated with remote operation are not affected by the Reset key. To minimize inadvertent operation, Reset needs to be confirmed by a second key-press. This is done using a menu on the dot-matrix display:



Yes confirms the action, and the 4950 is reset.

No cancels the reset action. The instrument returns to the state which was active before the Reset key was pressed.

Ext'trig

The Ext'trig key disables the internal triggers and enables the following external trigger sources:

- Front panel 'Sample' key;
- Remote IEEE 488.1 trigger 'GET';
- Remote IEEE 488.2 trigger '*TRG'.

External trigger mode is the default at power-on, with the Ext annunciator lit on the main display. External trigger mode can be cancelled by a second press on the Ext'trig key. Internal triggers are enabled and the annunciator is turned off.

Sample

The Sample key triggers a single-shot measurement when in External Trigger mode.

Busy Annunciator

During externally-triggered measurements, the Busy annunciator in the main display is lit. This is not used when in internal trigger mode for normal measurements.

During selftest, input zero, or any calibration operation, the Busy annunciator is lit irrespective of trigger source.

Local

The Local key returns the 4950 to front panel control when operating on the IEEE 488 bus, provided that it is not disabled by the local lockout facility (IEEE 488.1 subset RL1).

Refer to *Section 5, Page 5-2*.

SRQ

The SRQ key is a request for service from the controller when operating on the IEEE 488 bus, setting the URQ bit (bit 6) in the Standard-defined Event Status Register.

Refer to *Section 5, Page 5-25*.

Caltrig

This triggers a calibration event when Calibration mode is enabled in Local Control.

Refer to *Pages 4-36 to 4-38*.

Zero

This triggers an Input Zero operation when in Local Control, only in the following functions:

DC Voltage; DC Current; Ohms

The **Zero** operation is similar to calibration operations, in that a separate input zero store is held in non-volatile RAM for the Zero band of each Range in the above functions. It provides a zero correction which does not need updating when the instrument is powered on.

Before pressing the Zero key, all wires of the input lead must be shorted together at the 4mm plug end. New correction data overwrites previous data already in the store.

No Zero Operation in Calibration Modes

The Input Zero operation cannot be performed when either calibration mode is enabled. In fact a zero band calibration clears the Input Zero correction store for that range, as it stores new zero correction data in the zero band calibration memory.

Calibration Operations

Important

The descriptions in the following pages are intended only as a guide to the operations available to calibrate the instrument. They contain neither examples nor calibration routines, and should NOT be used directly as a basis for calibrating any part of the instrument. Some of the commands, if used unwisely, will obliterate an expensive calibration or recalibration.

For a guide to calibration routines refer to *Section 8*.

Use of Control Software

It is likely that the majority of users will employ the suite of control software supplied with the 4950. This allows an operator to drive the various specialized comparison and calibration tasks of the system without the need to program individual commands and queries. Refer to *Section 1 Pages 1-6/7*.

Operating instructions for the Control Software are given in documentation which accompanies the software package. The following information is provided for users whose requirements are not met by the suite of programs, and who need to use front panel control. Refer to the Caution at the top of this page.

General Outline of Calibration Operations

The calibration process generally conforms to a set sequence of operation:

1. The rear-panel switch must be set to ENABLE, then calibration is enabled by pressing the Cal key (this may need further parameters to be specified). An optional parameter is available for use when the calibration is to be performed at a non-nominal value.
2. With the appropriate analog input applied, the calibration operation is triggered for the pre-selected function, range, measurement band (and frequency band when in AC functions). The relevant corrections are calculated and stored in non-volatile memory.
3. Other operations can be carried out, such as setting the calendar/clock or recording further details of the calibration.
4. When calibration is complete, calibration is finally exited, then disabled by setting the rear panel switch to DISABLE.

Continued overleaf

Subsequently, in normal use; gain calibrations (and flatness calibrations for AC functions) are applied to correct the pre-selected function, range, measurement band and frequency band.

CAL Group of Menus - Overall View

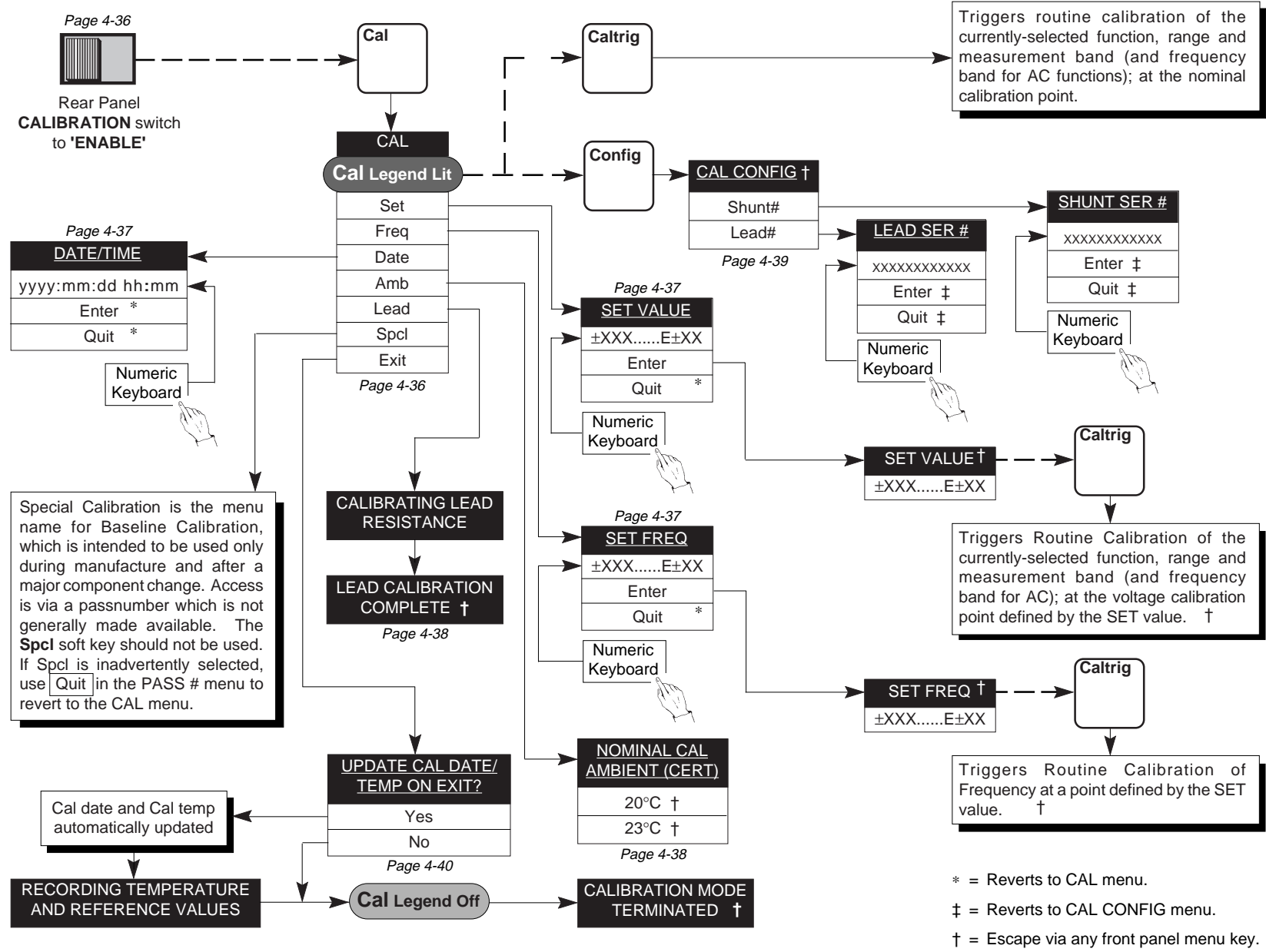

Calibration Menus

Front Panel Cal Key

The Cal key on the front panel causes the CAL menu to be displayed in the dot matrix display, so long as the instrument is not already in Cal mode.

This menu provides access to the calibration menus, also permitting some other non-volatile memory data to be accessed and changed.

CAL Group of Menus

A description of the User Interface is given in *Section 3* for the main functions.

If you are unfamiliar with the front panel controls, you should complete the quick tour in *Section 3*.

To give an overall view, movement among the CAL group of menus is described by the diagram on *page 4-35*.

Access Conditions

Rear panel switch S2 provides access to the CAL menu, and to the non-volatile calibration memory. S2 must be set to 'ENABLE' for calibration.

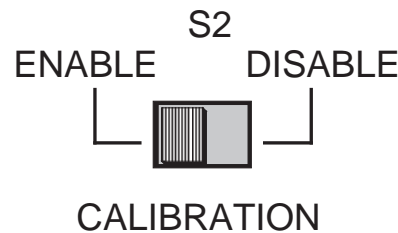

S2 is recessed to avoid inadvertent operation. A paper seal can be placed over the switch to protect calibration.

CAL Menu

Pressing the Cal key opens the CAL menu. The main group of calibration menus is available.

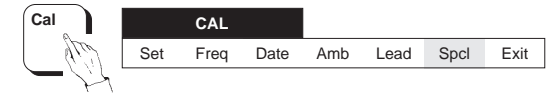

Important:

In this and other calibration menus the **Caltrig** key is enabled, and when pressed alters the calibration memory. To reduce the possibility of inadvertently obliterating the previous calibration, the menu should be used only during a genuine recalibration. Refer to *Section 8*.

Cal Trigger

Once the 'Cal' legend is lit, the major function hard keys can be selected and the various ranges/bands calibrated at nominal points, using the **Caltrig** direct action key.

SET Cal Trigger

If the values are not exactly at the cardinal points, then Set in the CAL menu can be used to inform the instrument of the exact value.

Note: Do not attempt to enter the special calibration mode. The SPCL soft key is for service use only:

Special Calibration is the menu name for Baseline Calibration, which is intended to be used only during manufacture and after a major component change. Access is via a passnumber which is not made available generally. The **Spcl** soft key should not be used.

If Spcl is inadvertently selected, use **Quit** in the PASS # menu to revert to the CAL menu.

CAL Menu Description

The CAL menu defines six *menu* keys, all of which are *not selected* at Power On. They are described below.:

Set Opens the SET VALUE menu. This shows the nominal value, and the numeric keyboard is activated:

SET VALUE			
(Nominal Value)		Enter	Quit

A particular calibration source value can be entered as target value for non-nominal calibration, using the numeric keyboard.

Enter writes the new target value into non-volatile RAM, and generates a new SET VALUE display. Pressing the Caltrig key performs the 'SET' calibration. After calibration has completed, the display persists until a front panel menu key is pressed.

Quit aborts the attempt to reset the target value and transfers back to the CAL menu. The newly-written value is destroyed.

Freq Opens the SET FREQ menu. This shows the nominal frequency, and the numeric keyboard is activated:

SET FREQ			
(Nominal Frequency)		Enter	Quit

A particular calibration source frequency can be entered as target value for frequency calibration, using the numeric keyboard.

Enter writes the new frequency into non-volatile RAM, and generates a new SET FREQ display. Pressing the Caltrig key performs the calibration. The display persists until a front panel menu key is pressed.

Quit aborts the attempt to reset the frequency and transfers back to the CAL menu. The new frequency is destroyed.

Date Opens the DATE/TIME menu. This shows the present date in the following form:

DATE/TIME			
yyyy : mm : dd	hh : mm	Enter	Quit

having the meanings:

yyyy = 4-character year
 mm = 2-character month
 dd = 2-character day
 hh = 2-character hour (24 hr clock)
 mm = 2-character minute

The date and time can be changed in this menu. The initial display is a reminder of the required format. By pressing the numeric keyboard keys, the present date and time can be written in the same format, overwriting the display from left to right with successive keystrokes (the colons are permanent and ignored. Errors can be corrected using the backspace key.

Enter causes the internal calendar/clock to be reset to the date/time just written.

Quit aborts the attempt to reset the calendar/clock, which continues uninterrupted running.

Both Enter and Quit transfer back to the CAL menu.

CAL Menu Description (Contd.)

Amb Opens the NOMINAL CAL AMBIENT (CERT) menu:



This menu permits a user to select the external ambient temperature which prevailed at the time that the certified calibration was performed. It is assumed that temperature control was being used, but otherwise the figure closest to the actual temperature should be chosen.

Subsequently, in normal use, it is possible to access the CERT AMB figure by selecting **Temp** in the MONITOR menu, then **Intl** in the TEMPERATURE menu. This opens the INTERNAL TEMP menu (refer to *page 4-6*).

Lead This key is used to calibrate the input cable assembly for use in 2-wire Ohms mode. To enable the calibration, the instrument must first be set as follows:

- Ohms function, 10 Ω range, 0% or 10% measurement band;
- 2w Ω (OHMS CONFIG menu);
- calibration enabled, in the CAL menu;
- the standard input cable assembly must be connected to the instrument front panel, with the remote 4mm Hi plug inserted into the back socket of the 4mm Lo plug.

Pressing the Lead soft key carries out a resistance measurement between the Hi and Lo input terminals; and stores the resistance value in non-volatile RAM.

While the lead is being calibrated, the following message appears on the dot-matrix display.

CALIBRATING LEAD RESISTANCE

When the lead calibration has been completed, the following message appears on the dot-matrix display.

LEAD CALIBRATION COMPLETE

Escape by pressing any front panel menu key.

Subsequently, when measuring in 2-wire Ohms mode only, the stored value is subtracted from the measured value to compensate for the resistance of the leads.

It is possible to access the characterized lead resistance value by entering the STATUS CONFIG menu, and selecting **Lead**. The resulting LEAD SERIAL # display also shows the serial number of the lead (refer to *page 4-5*). The serial number is entered separately during calibration, in the CAL CONFIG - LEAD SER # menu (*page 4-39*).

Spcl This key is used to enter Baseline calibration mode, and should not be used except by servicing formations and during manufacture.

Refer to the **Caution** on *page 5-38*

Exit This key is described on *page 4-40*.

CAL CONFIG MENU

When in Calibration mode, pressing the front panel Config key allows a user to register the serial numbers of the Input lead (needed for 2-wire

Ohms operation) and the 4953 external 10A shunt (needed for the 10A DCI and 10A ACI ranges).

CAL CONFIG menu Description

To enter the serial number of the Input lead or 4953, press the Config key while calibration is enabled. This opens the CAL CONFIG menu:



This menu accesses two menu keys:

Shunt# This key is used to open the SHUNT SER # menu:



The numeric keyboard is activated, and the 4953 10A Shunt serial number can be entered.

Enter Registers the serial number in non-volatile memory.

Quit Leaves the existing previous serial number in non-volatile memory.

Pressing either Enter or Quit reverts to the CAL CONFIG menu; then escape by pressing any front panel menu key.

Lead# This key is used to open the LEAD SER # menu:

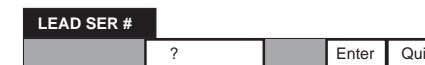

The numeric keyboard is activated, and the serial number of the input lead can be entered.

Enter Registers the serial number in non-volatile memory.

Quit Leaves the existing previous serial number in non-volatile memory.

Pressing either Enter or Quit reverts to the CAL CONFIG menu; then escape by pressing any front panel menu key.

CAL Menu Description (Contd.)

Exit This key is used to close either calibration mode. It opens the following menu:



Yes The calibration date and internal temperature are automatically updated before the instrument exits calibration mode. While this is in progress, the following message appears on the dot-matrix display:



No The instrument exits calibration mode directly, without updating the calibration date and temperature.

Exit from Calibration mode

When the above processes are complete, the Cal legend on the main display is extinguished, the Caltrig key becomes inactive, and the following message appears on the dot-matrix display:

Press any front panel menu key to escape.



*Appendix A to
Section 4 of the
User's Handbook for
Model 4950*

Note to users: For the sake of completeness, this appendix collects together the error codes which might be generated either on the instrument front panel, or via the IEEE 488 system bus.

Error Detection

All errors which cannot be recovered without the user's knowledge, result in some system action to inform the user via a message, and where possible restore the system to an operational condition. Errors are classified by the method with which they are handled. Recoverable errors report the

error and then continue. System errors which cannot be recovered cause the system to halt with a message displayed. Restarting the instrument from Power On may clear the error, but generally such messages are caused by hardware or software faults, which require user action.

Error Messages

Fatal System Errors

For all fatal system errors, the error condition is reported only via the front panel. The processor stops after displaying the message. A user must respond by retrying operation from power on, and

initiate repair if the fault persists. The following is a list of error numbers displayed, with their associated fault descriptions:

- 9000 - System Kernel Fault
- 9001 - Run Time System Error
- 9002 - Unexpected Exception
- 9003 - PROM Sumcheck Failure
- 9004 - RAM Check Failure
- 9005 - Serial Interface Fault (Subdivided)
- 9006 - Option Test Failure
- 9007 - Unknown Engine Instrn
- 9008 - NV RAM Clear Fault
- 9009 - Stack Overflow
- 9099 - Undefined Fatal Error

Recoverable Errors

Types of Recoverable Errors

These consist of **Command Errors**, **Execution Errors** and **Device-Dependent Errors**. Command Errors can only be generated due to incorrect remote programming. Some Execution Errors and all Device-Dependent Errors can be generated by manual operation as well. Each of the reportable Command, Execution and Device-Dependent Errors are identified by a code number.

Error Reporting

Whether in response to a bus or a keyboard error, the instrument reports an Execution Error or a Device-Dependent Error to both local and remote operators. It displays the error on the front panel; it also sets the ESR bit, and adds the error to the queue.

A Command Error is related to bus command syntax, and so is not reported via the front panel.

Command Error (CME)

(Remote operation only)

A Command Error is generated when the remote command does not conform, either to the device command syntax, or to the IEEE 488.2 generic syntax. The CME bit (5) is set *true* in the Standard-defined Event Status Byte, and the error code number is appended to the Command Error queue.

The error is reported by the mechanisms described in the sub-section of Section 5 which deals with status reporting, and the queue entries can be read destructively as LIFO by the query command CMQ?.

The Command Error numbers, and their associated descriptions, are as follows:

List of Command Errors

- 0000 - No Command Error
- 7001 - suspect range parameter
- 7002 - suspect band parameter
- 7003 - suspect numeric parameter
- 7004 - suspect mnemonic
- 7005 - suspect pass number
- 7006 - get not allowed
- 7007 - more than 9 characters in field
- 7008 - incorrect arb blk term
- 7009 - arb message length mismatch
- 7010 - arb preamble numeric incorrect
- 7011 - arb data missing
- 7012 - no trailing string term
- 7013 - too many chars in string
- 7014 - string data missing
- 7015 - unknown command type
- 7016 - incorrect message unit terminator
- 7017 - unknown command

Execution Errors (EXE)

An Execution Error is generated if a received command cannot be executed due to it being incompatible with the current device state, or because it attempts to command parameters which are out-of-limits.

In remote operation, the EXE bit (4) is set *true* in the Standard-defined Event Status Byte, and the error code number is appended to the Execution Error queue.

The error is reported by the mechanisms described in the sub-section of Section 5 which deals with status reporting, and the queue entries can be read destructively as LIFO by the query command EXQ?.

The Execution Error numbers, and their associated descriptions, are as follows:

List of Execution Errors

- 0000 - No Execution Error
- 1001 - Option not installed
- 1002 - Calibration disabled
- 1005 - Input zero not allowed
- 1006 - Cal mode change must be via exit
- 1007 - Invalid numeric data
- 1008 - Must be in AC function
- 1009 - Pass number entry error
- 1012 - No more errors in list
- 1013 - Data out of limit
- 1014 - Illegal range/function combination
- 1015 - Command only allowed in remote
- 1016 - Not in special calibration
- 1019 - Temperature cal needs BASE cal enb
- 1020 - Lead cal needs CERT cal enabled
- 1021 - Test not allowed when cal enabled
- 1023 - Zero not allowed when cal enabled
- 1024 - Invalid date format entered
- 1025 - External trigger mode not selected
- 1026 - Illegal band selection
- 1027 - Shunt serial number incorrect
- 1028 - 10A selection requires shunt#
- 1029 - BASELINE calibration not enabled
- 1030 - HIACC mode required
- 1031 - 2 wire reqd. for lead calibration
- 1032 - 2 wire selection requires lead#
- 1033 - Lead serial number incorrect
- 1034 - Base selection invalid in cal mode
- 1035 - Cert selection invalid in cal mode

Recoverable Errors (Contd.)

Device-Dependent Messages: Normal and Calibration Operations

Device-Dependent Errors (DDE)

A Device-Dependent Error is generated if the device detects an internal operating fault (eg. during self-test). The DDE bit (3) is set *true* in the Standard-defined Event Status Byte, and the error code number is appended to the Device-Dependent Error queue. The code number and description appear on the right-hand display, remaining visible until the next key-press or remote command.

In Remote, the error is reported by the mechanisms described in the sub-section of Section 5 which deals with status reporting, and the queue entries can be read destructively as LIFO by the query command DDQ?.

Device-Dependent Error Lists

Device-dependent errors are associated mainly with normal operation or with test operations. The following error numbers are therefore listed in these categories. The error list for normal operation, with their associated descriptions, is given first, followed by the selftest error list.

Normal Operation

- 0000 - No Device Dependent Errors
- 2001 - Zero correction error
- 2002 - Gain+ correction error
- 2003 - Gain- correction error
- 2004 - AC linearity correction error
- 2005 - Lead correction error
- 2006 - Temperature correction error
- 2007 - Signal outside band
- 2008 - Input zero correction error
- 2009 - Bus address corrupt
- 2010 - Bad data from analog sub-system
- 2011 - Bad copy of measurement correction
- 2012 - Measurement correction invalid
- 2013 - NV RAM write failure
- 2014 - NV RAM read failure
- 2015 - Undefined cal/test error

Selftest Operation

- 2100 - A-D: Zero
- 2101 - A-D: Main Reference
- 2102 - A-D: Check Reference
- 2103 - A-D: PREF16
- 2104 - A-D: NREF16
- 2105 - A-D: Main Reference Drift
- 2105 - check again after warm-up
- 2105 - outside 30 day cal period
- 2105 - internal temp. mismatch
- 2106 - A-D: PREF16 Drift
- 2106 - check again after warm-up
- 2106 - outside 30 day cal period
- 2106 - internal temp. mismatch
- 2107 - A-D: NREF16 Drift
- 2107 - check again after warm-up
- 2107 - outside 30 day cal period
- 2107 - internal temp. mismatch

2108 - A-D: Reference Ratio Drift	2500 - AC System: AC gain
2108 - check again after warm-up	2501 - AC System: S&H tracking
2108 - outside 30 day cal period	2502 - AC System: S&H holding
2108 - internal temp. mismatch	2503 - AC System: Quasi-sine gain
	2504 - AC System: Chop 100Hz filter
2200 - DC Preamp: Zero 100mV	2505 - AC System: Chop 10Hz
2201 - DC Preamp: Zero 1V	2506 - AC System: Linearity
2202 - DC Preamp: Zero 10V	
2203 - DC Preamp: Self Test Zero	2600 - Ohms: 5V Clamp
2204 - DC Preamp: Gain +1V	2601 - Ohms: 1mA Source
2205 - DC Preamp: Gain -1V	2602 - Ohms: 100 μ A Source
2206 - DC Preamp: Gain +100mV	2603 - Ohms: 10 μ A Source
2207 - DC Preamp: Gain -100mV	2604 - Ohms: 1 μ A Source
2208 - DC Preamp: Gain +10V	2605 - Ohms: 100nA Source
2209 - DC Preamp: Filter 1V	2606 - Ohms: 10V Output
	2607 - Ohms: Zero
2300 - Power Supply: +36V	
2301 - Power Supply: -36V	2700 - Current: 10mA 10R
2302 - Power Supply: +5V	2701 - Current: 10mA 1R
2303 - Power Supply: +15V	2702 - Current: 10mA 0R1
2304 - Power Supply: -15V	2703 - Current: 1mA 100R
2305 - Temperature 1	2704 - Current: 100 μ A 1k
2306 - Temperature 2	2705 - Current: 4wr/2wr switch
2307 - DC Preamp: div 60 atten.	2706 - Current: Ohms Isolation
	2707 - Current: Fuse Test
2400 - AC Preamp: Zero x1	
2401 - AC Preamp: Zero x3	2800 - General: Digital p/s
2402 - AC Preamp: Pos 1Vx1	2801 - General: Battery voltage
2403 - AC Preamp: Neg 1Vx1	2802 - General: RAM test
2404 - AC Preamp: Pos 1Vx3	
2405 - AC Preamp: div 10 atten.	
2406 - AC Preamp: div 100 atten.	
2407 - AC Preamp: div 743 atten.	
2408 - AC Preamp: 600Hz	
2409 - AC System: O/L check 13V	
2410 - AC Preamp: O/L check 13V	

SECTION 5

SYSTEMS APPLICATION
via the IEEE 488 INTERFACE

Section 5 Contents List

Alphabetical Index of IEEE 488.2 Codes used in the 4950	5-0-4 to 5-0-6
Introductory Material	
Introduction	
Interface Capability	5-1
Interconnections	5-3
Using the 4950 in a System	
Addressing the 4950	5-4
Remote Operation	5-5
Programming Guidance	5-6
Message Exchange Models	5-12
Service Request	5-16
Retrieval of Device Status Information	
The 4950 Status Reporting Structure	5-17
4950 Status Reporting - Detail (see also pages 5-59 to 5-68)	5-21
4950 Commands and Queries - Syntax Diagrams	
Measurement Definition - Major Functions	
DCV Function	5-28
ACV Function	5-30
Resistance Function	5-32
DCI Function	5-34
ACI Function	5-36
Measurement Parameters	
Accuracy Mode	5-39
Correction Selector	5-40
Trigger Source Selector	5-42
Band Limits	5-42
Measurement Definition - SRQ Generation	
SRQ Origination	5-43
Trigger Reading	
Execute Trigger	5-44
Execute 'Input Zero'	5-44
Measurement Results	
Reading Recall	5-46
Frequency Readings	5-47
Return the Quality of Measurement	5-48
Recall the Sample Size	5-49
Instrument Stability Status	5-50

Instrument Configuration		
Instrument I/D		5-51
Set 10A Shunt Serial Number		5-52
Query Shunt Serial Number		5-53
Set 2-Wire Ohms Lead Serial Number		5-54
Query 2-Wire Ohms Lead Serial Number		5-55
Recall Selected Ambient Temperature of Certified Calibration		5-56
Recall the Present / Certified-Calibration / Baseline-Calibration Date		5-57
Return the Instrument's Hardware Fitment		5-58
Status Data Manipulation		
Status Reporting (see also page 5-17)		5-59
Power On Status Clear		5-66
Clear Status		5-68
Error Reporting		
Error Detection		5-69
Recall Device Errors		5-70
Recall Execution Errors		5-71
Recall Command Errors		5-72
Test Operations		
Confidence Selftest		5-73
Resume Confidence Selftest		5-74
Internal Operations		
Instrument Reset to Default Condition		5-75
Operation Complete		5-76
Wait		5-77
General Queries		
Recall Stored User Data		5-78
Recall Present Time		5-79
Calibration Commands and Messages		
General Outline		5-80
Enable Calibration		5-82
Trigger Calibration		5-84
Set 'Nominal' Target Calibration Point		5-85
Recall 'Nominal' Target Calibration Point		5-86
Trigger Frequency Calibration		5-87
Set 'Nominal' Target Frequency Calibration Point		5-88
Recall 'Nominal' Target Frequency Calibration Point		5-89
Set 10A Shunt Serial Number		5-90
Set 2-Wire Ohms Lead Serial Number		5-91
Characterize 2-Wire Ohms Lead		5-92
Record Nominal Ambient Temp (Cert Cal)		5-93
Set Internal Clock/Calendar		5-94
Entry of Protected User Data		5-95
Exit from Calibration		5-96
Appendix A:	IEEE 488.2 Device Documentation Requirements	5-A1
Appendix B:	4950 Device Settings at Power On	5-B1

Alphabetical Index of IEEE 488.2 Codes used in the 4950

Common Commands/Queries

Common Command/ Query	Description	Page 5-
*CLS	Clears event registers and queues (not O/P queue)	68
*ESE	Enables Standard-defined Event Register bits	62 (43)
*ESE?	Returns Event Status Enable register mask value	62
*ESR?	Reads the Event Status register	63
*IDN?	Reports manufacturer, model, etc.	51
*OPC	Conforms, but not relevant to 4950 application	76
*OPC?	Conforms, but not relevant to 4950 application	76
*OPT?	Recalls instrument hardware fitment	58
*PSC	Sets/resets power-on status clear flag	66
*PSC?	Recalls power-on status clear flag	67
*PUD	Allows entry of user data to protected store	95
*PUD?	Recalls user-entered data	79
*RST	Resets instrument to power on condition	75 / App B
*SRE	Enables Service Request Byte bits	64 (43)
*SRE?	Returns Service Request Byte mask value	64
*STB?	Non-destructively reads Service Request Byte	65
*TRG	Causes a single reading to be taken	44
*TST?	Performs Operational Test	73
*WAI	Conforms, but not relevant to 4950 application	77

Calibration Operations

Device-Dependent Command/Query	Description	Page 5-
CAL?	Triggers calibration operation	84
CAL_FREQ?	Triggers frequency calibration operation	87
CERT_AMB	Records the ambient temperature during Cert. Cal.	93
CHSE LEAD	Characterizes the 2-wire input lead resistance	92
DATE	Sets calendar and clock	94
ENBCAL	Enables calibration	82
EXIT	Disables calibration	96
LEAD_NO	Enters the serial number of the 2-wire Input Lead to be characterized	91
NOMINAL	Pre-sets a non-default Calibration Target Value	85
NOMINAL?	Returns the active non-default Calibration Target Value	86
NOM_FREQ	Pre-sets a non-default Frequency Calibration Target Value	88
NOM_FREQ?	Returns the active non-default Frequency Calibration Target Value	89
*PUD	Allows entry of user data to protected store	95
SHUNT_NO	Enters the Serial Number of the External 10A Shunt to be registered	90

Normal Operations

Device-Dependent Command/Query	Description	Page 5-
ACCURACY	Sets High (Slow) or Low (Fast) Accuracy mode	39
ACI	Selects AC Current function	36
ACV	Selects AC Voltage function	30
BAND	Selects Band Limits OFF or ON	42
CERT_AMB?	Recalls the recorded ambient temperature of Certified Calibration	56
CMQ?	Recalls most-recent command error from queue	72
CORRECTN	Selects Base or Certified calibration corrections	40
DATE?	Returns the Present / Certified / Baseline date	57
DCI	Selects DC Current function	34
DCV	Selects DC Voltage function	28
DDQ?	Recalls most-recent device error from queue	70
DEVTN?	Calculates and returns the quality of the internal sample	48
EXQ?	Recalls Execution Errors	71
FREQ?	Recalls frequency of next measurement and updates	47
LEAD_NO	Enters the 2-wire Input Lead serial number	54
LEAD_NO?	Returns the characterized Input Lead serial number and measured value	55
MESE	Enables Measurement Event Status Register bits	60 (43)
MESE?	Recalls Measurement Event Status Enable Register bits	60
MESR?	Reads Measurement Event Status Register	61
OHMS	Selects Resistance function	32
RDG?	Recalls most-recent reading	46
RTST?	Resumes Confidence Test	74
SHUNT_NO	Enters the External 10A Shunt serial number	52
SHUNT_NO?	Returns the Registered 10A Shunt serial number	53
SMP_SIZE?	Returns the number of conversions in the sample	49
STANDBY?	Recalls the time remaining in warm-up period	50
TEMP?	Recalls the Present Temperature / Temperature Difference	56
TIME?	Recalls the time the query was processed	79
TRIG_SRCE	Selects internal or external triggers	42
ZERO?	Triggers 'Input Zero' measurement	45

PTO for other mnemonics

Other Mnemonics, their Commands and Functions

Mnemonic	Command of which the mnemonic is a parameter	Mnemonic Function	Page 5-
ABSOLUTE	DEVTN?	Returns Quality in values of the selected function.	48
BASE	CORRECTN	Applies Baseline-Calibration Corrections.	41
BASE	DATE	Returns the date of the most-recent Baseline Calibration.	57
BASE	ENBCAL	Enables Baseline Calibration (Not to be used).	82
BASE	TEMP	Returns difference between present internal temperature and that at Baseline Calibration.	56
CERTIFIED	CORRECTN	Applies Certified-Calibration Corrections.	41
CERTIFIED	DATE	Returns the date of the most-recent Certified Calibration.	57
CERTIFIED	ENBCAL	Enables Certified Calibration (if rear panel switch is set to 'ENABLE').	82
CERTIFIED	TEMP	Returns difference between present internal temperature and that at Certified Calibration.	56
DATE	EXIT	On exit from calibration mode, Annotates the current calibration with Date and Internal Temperature.	96
DEG20C	CERT_AMB	Records that Certified Calibration was at 20°C ambient.	93
DEG23C	CERT_AMB	Records that Certified Calibration was at 23°C ambient.	93
EXT	TRIG_SRCE	Selects external triggers.	42
FREQ_...	ACI	Selects ACI Frequency Band.	36
FREQ_...	ACV	Selects ACV Frequency Band.	30
FWR	OHMS	Selects Four-Wire OHMS Measurement.	32
HIGH	ACCURACY	Selects High Accuracy Mode.	39
INT	TRIG_SRCE	Selects Internal Triggers.	42
LCL_GUARD	All Main Functions	Selects Local Guard	28-37
LEAD	CHSE	Characterizes the input lead for 2-wire Ohms.	92
LOW	ACCURACY	Selects Low Accuracy Mode.	39
OFF	BAND	Selects Band Limits OFF.	42
ON	BAND	Selects Band Limits ON.	42
PCENT_...	All Main Functions	Selects (by range) Function's Measurement Band.	28-37
REM_GUARD	All Main Functions	Selects Remote Guard	28-37
READING	DEVTN?	Returns Quality in ppm of the measurement value	48
TWR	OHMS	Selects Two-Wire OHMS Measurement.	32

SECTION 5 SYSTEMS APPLICATION VIA THE IEEE 488 INTERFACE

Introduction

This first part of Section 5 gives the information necessary to put the 4950 into operation on the IEEE 488 bus. As some operators will be first-time users of the bus, the text is pitched at an introductory level. For more detailed information, refer to the standard specification, which appears in the publications ANSI/IEEE Std. 488.1-1987 and IEEE Std. 488.2-1988.

Section Contents

The section is divided so as to group certain types of information together. These divisions are:

Interface Capability - IEEE 488.1 subsets which are implemented in the model 4950, satisfying IEEE 488.2.

Interconnections - the rear panel IEEE 488 connector and its pin designations.

Typical System - a brief view of a typical process using the 4950 to measure the output from a programmable AC voltage source.

Using the 4950 in a System - addressing, remote operation and programming guidance - introduction to syntax diagrams.

Message Exchange - a simplified model showing how the 4950 deals with incoming and outgoing messages.

Service Request - why the 4950 needs the controller's attention and how it gets it.

Retrieval of Device Status Information - how the IEEE 488.2 model is adapted to the 4950.

Programming Messages - detailed descriptions of both common and device-specific commands and queries.

Interface Capability

IEEE Standards 488.1 and 488.2

The 4950 conforms to the Standard Specification IEEE488.1-1987: 'IEEE Standard Digital Interface for Programmable Instrumentation', and to IEEE 488.2-1988: 'Codes, Formats, Protocols and Common Commands'.

The 4950 in IEEE 488.2 Terminology

In IEEE 488.2 terminology the 4950 is a **device** containing a **system interface**. It can be connected to a **system** via its **system bus** and set into programmed communication with other bus-connected **devices** under the direction of a **system controller**.

Programming Options

The instrument can be programmed via the IEEE Interface, to:

- Change its operating state (Function, Range, Frequency etc).
- Transmit results of measurements, and its own status data, over the bus.
- Request service from the system controller.

Capability Codes

To conform to the IEEE 488.1 standard specification, it is not essential for a device to encompass the full range of bus capabilities.

But for IEEE 488.2, the device must conform exactly to a specific subset of IEEE 488.1, with a minimal choice of optional capabilities.

The IEEE 488.1 document describes and codes the standard bus features, for manufacturers to give brief coded descriptions of their own interfaces' overall capability. For IEEE 488.2, this description is required to be part of the device documentation. A code set is often printed on the product itself.

The codes which apply to the 4950 are given in *Table 5.1*, together with short descriptions. They also appear on the rear of the instrument next to the interface connector. These codes conform to the capabilities required by IEEE 488.2.

Appendix C of the IEEE 488.1 document contains a fuller description of each code.

IEEE 488.1 Subset	Interface Function
SH1	Source Handshake Capability
AH1	Acceptor Handshake Capability
T6	Talker (basic talker, serial poll, unaddressed to talk if addressed to listen)
L4	Listener (basic listener, unaddressed to listen if addressed to talk)
SR1	Service Request Capability
RL1	Remote/Local Capability (including Local Lockout)
PP0	No Parallel Poll Capability
DC1	Device Clear Capability
DT1	Device Trigger Capability
C0	No Controller Capability
E2	Open-Collector and Three-State Drivers

Table 5.1 IEEE Interface Capability

Bus Addresses

When an IEEE 488 system comprises several instruments, a unique 'Address' is assigned to each to enable the controller to communicate with them individually.

Only one address is required for the 4950, as the controller adds information to it to define either 'talk' or 'listen'. The method of setting the address, and the point at which the user-initiated address is recognized by the 4950, is detailed on *page 5-4*.

The 4950 has a single primary address, which can be set by the user to any value within the range from 0 to 30 inclusive. It cannot be made to respond to any address outside this range.

Secondary addressing is not programmed.

Interconnections

Instruments fitted with an IEEE 488 interface communicate with each other through a standard set of interconnecting cables, as specified in the IEEE 488.1 Standard document.

The interface socket, SK7, is fitted on the rear panel. It accommodates the specified connector, whose pin designations are also standardized as shown in *Fig. 5.1* and *Table 5.2*.

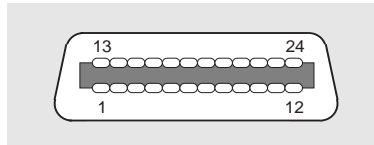

Fig 5.1 Connector SK7 - Pin Layout

Pin No.	Name	Description
1	DIO 1	Data Input/Output Line 1
2	DIO 2	Data Input/Output Line 2
3	DIO 3	Data Input/Output Line 3
4	DIO 4	Data Input/Output Line 4
5	EOI	End or Identify
6	DAV	Data Valid
7	NRFD	Not Ready For Data
8	NDAC	Not Data Accepted
9	IFC	Interface Clear
10	SRQ	Service Request
11	ATN	Attention
12	SHIELD	Screening on cable (connected to 4950 safety ground)
13	DIO 5	Data Input/Output Line 5
14	DIO 6	Data Input/Output Line 6
15	DIO 7	Data Input/Output Line 7
16	DIO 8	Data Input/Output Line 8
17	REN	Remote Enable
18	GND 6	Gnd wire of DAV twisted pair
19	GND 7	Gnd wire of NRFD twisted pair
20	GND 8	Gnd wire of NDAC twisted pair
21	GND 9	Gnd wire of IFC twisted pair
22	GND 10	Gnd wire of SRQ twisted pair
23	GND 11	Gnd wire of ATN twisted pair
24	GND	4950 Logic Ground (internally connected to Safety Ground)

Table 5.2 Socket SK7 - Pin Designations

Using the 4950 in a System

Addressing the 4950

Address Recognition

With an address selected in the range 0 to 30; control may be manual, or remote as part of a system on the Bus. The address must be the same as that used in the controller program to activate the 4950. The 4950 is always aware of its stored address, responding to Talk or Listen commands from the controller at that address. When the address is changed by the user, the 4950 recognizes its new address and ignores its old address, as soon as it is stored by the user pressing the **Enter** key in the **ADDRESS** menu.

Setting the Bus Address

The instrument address can only be set manually; using the ADDRESS menu, which is accessed via the STATUS and STATUS CONFIG menus.

To change the address, proceed as follows:

- Press the **Status** key to see the **STATUS** menu. If the instrument is still warming up, then the following display will appear:



If the warm-up period has expired, then the following display will appear:



This menu defines five positions on the dot-matrix display (refer to Section 3 for details). The soft keys are deactivated, and play no part in setting the address.

- Press the **Config** key to see the **STATUS CONFIG** menu:



This menu defines four soft *menu* keys; at present we are interested only in the Addr key.

Addr: displays the ADDRESS menu, to review or change the IEEE-488 bus address of the instrument.

ADDRESS Menu

- Press the **Addr** soft key to see the **ADDRESS** menu:



This menu permits entry of a value to be used as an IEEE-488 bus address. Initially, the menu displays the present address value (in the position shown above by XX), and the numeric-keyboard keys are activated. Any valid numeric value (0-30) may be entered, an invalid address resulting in the display message '1007: Invalid numeric data', leaving the existing address unchanged.

Pressing Enter stores the new value (or restores the old value if unchanged); pressing Quit leaves the existing address unchanged. Either Enter or Quit causes exit back to the STATUS CONFIG menu, then press any required function key to escape.

Remote Operation

General

When the 4950 is operating under the direction of the controller, the legend **rem** appears on the Main display, and all front panel controls are disabled except **Power**, **SRQ** and **Local** (as the 4950 has RL1 capability, including 'Local Lockout'; even the **Local** key can be disabled by the controller).

The power-up sequence is performed as for manual operation. The 4950 can be programmed to generate an SRQ at power-up, also preparing a status response for transmission to the controller when interrogated by a subsequent serial poll.

Transfer to Local Operation (GTL)

The 4950 can be switched into 'Local' operation (by Command GTL), permitting a user to take manual control from the front panel. The system controller regains 'Remote' control by sending the overriding command:

Listen Address with *REN* true

The controller addresses the 4950 as a listener with the Remote Enable management line true (Low). This returns the 4950 from local to remote control.

'Device Clear'

Either of the commands *DCL* or *SDC* will force the following instrument states:

- all IEEE 488 input and output buffers cleared;
- parser reset to the beginning of a message;
- any device-dependent message bus holdoffs cleared.

These commands **will not**:

- change any settings or stored data within the device except as listed above;
- interrupt analog input;
- interrupt or affect any functions of the device not associated with the IEEE 488 system;
- change the status byte.

Levels of Reset

Three levels of reset are defined for IEEE 488.2 controllers, a complete system reset being accomplished by resetting at all three levels, in order, to every device. In other circumstances they may be used individually or in combination:

- IFC** Bus initialization;
- DCL** Message exchange initialization;
- *RST** Device initialization.

The effects of the *RST command are described on *page 5-75*.

Programming Guidance

Programming Elements

The 4950 operates within the syntax demands of IEEE 488.2. To alter its configuration, elicit information etc., it requires to be sent an address code followed by commands or queries.

The smallest program element capable of activation is called a 'program message unit' (*pmu*), which must conform to a standard structure (detailed later in this section). One *pmu* can be sent on its own, followed by a recognized 'terminator'; in which case it is known as a 'program message'. Several formally-complete *pmus* can be concatenated together, using semi-colons as separators, to form a program message. All program messages must be correctly terminated.

Activation

The 4950 cannot activate any commands or queries until it receives a message unit separator (;) or a correct message terminator.

The message terminator for the 4950 is the Hex number 0A, characterized in IEEE 488.2 as 'NL'. Alternatively, the 'End or Identify' (EOI) line can be set true with the last byte to be sent; this is represented on the syntax diagram by /[^]END/.

To assist in eliminating incorrect commands or queries, the 4950 checks for errors in the message, and can generate a service request (SRQ) if a syntax error occurs. To ensure that a prohibited state is not set up, it also checks each program message unit for validity. Generally, if it finds any errors in this phase the message unit is ignored; although for commands with errors associated with optional data elements, those elements ahead of the option path will be executed.

Conformance to IEEE 488.2

IEEE 488.2 defines sets of Mandatory and Optional Common Commands/Queries along with a standard method of Status Reporting. The 4950 conforms with all Mandatory Commands/Queries but not all the Options, and uses the defined Status Reporting method.

Note: Commands prefaced by asterisk, eg *TRG, are standard-defined 'Common' commands.

In addition to these Common Commands, the 4950 has a set of Device-Dependent Commands, defined by Datron to program the instrument into its various functions and ranges. IEEE 488.2 defines how these commands should be linked or separated (ie the syntax is defined). These device-dependent commands have been designed to be self-explanatory, while conforming to the standard-defined syntax.

The IEEE 488.2 also requires certain 'Device Documentation' to be supplied by the manufacturer of the device. The necessary data for the 4950 is included within the text of this section, and indexed by Appendix A at the back of the section.

Command Formation

The following paragraphs describe the types of command that are used to program the 4950.

A command (or 'Program Message Unit') can merely comprise a simple alphabetic code. But if there are alternative ways of programming within a command, this is signified by using a 'Command Program Header', followed by the appropriate 'Program Message Elements'.

An example of a simple command is the query 'FREQ?', which recalls the frequency of the most-recent reading.

An example of a more complex command is:

```
TRG_SRCE EXT
```

which will program the instrument to wait for, and respond to, externally generated triggers. In this example, TRG_SRCE is the Command Program Header, while EXT is a Program Message Element, and the space between is as described below for a 'Program Header Separator'.

'Forgiving Listening'

IEEE 488.2 closely specifies the format of messages to be transmitted by a conforming 'talker' device, imposing consistencies to clarify the exact meaning of any message received from the device.

Conversely, a conforming 'listener' device should be able to interpret a variety of received messages, coming from different types of controller. By limiting the language to the commonly-used ASCII character set, this condition is partly met. But IEEE 488.2 also insists that certain characters be used *only* as command symbols to separate and

specify the elements of concatenated strings:

- A succession of Message Units making up a complete Program Message must each be separated by a semi-colon (;).
- A Program Header is separated from its Message Elements by 'white space' - (i.e one or more non-printing ASCII characters in the ranges Hex 00 to 09 and 0B to 20) - denoted here by {phs} - Program Header Separator.
- Successive Message Elements of a Message Unit are each separated by a comma (,).
- In numeric data strings, all variants of a particular family of numeric representations (Nrf) are acceptable.
- No differentiation is made between upper and lower case characters.
- Program Messages may be terminated by a Line Feed - (ie the ASCII character at Hex 0A) - denoted by {NL} (Newline), or by EOI true with the last byte, or both.

An example of a complete Program Message could be:

```
DCV{phs}10,PCent_100,REM_GUArD;TRIG_srce{phs}EXT;*TrG{NL}
```

which will print as: DCV 10 ,PCent_100 ,REM_GUArD;TRIG_srce EXT;*TrG

This message appears visually as a jumbled string of characters, confusing to read due to the spacing (or lack of it). So IEEE 488.2 also permits optional 'white space' to be inserted within a string to improve its visual intelligibility, providing certain rules are followed:

- The 'white space' characters must be as defined earlier for the Program Header Separator.
- White space can be inserted *before* a Program Message Separator (;).

- White space can be inserted *before and/or after* a Program Message Element Separator (,).
- White space can be inserted *before and/or after* an Exponent Symbol (E) in a numeric string.

These rules are programmed into the 4950, giving it the nature of a 'Forgiving Listener', to ensure that it does not reject received commands or data which obey these rules.

IEEE 488.2 Syntax Diagrams

To standardize the approach to programming, the IEEE 488.2 Standard has introduced a form of 'Syntax Diagram', in which the possible command formation for particular messages can be given. The IEEE 488.2 syntax has been adhered to, so in the following descriptions of device-dependent commands, we have adopted the standard syntax diagram, with modified style to fit this handbook. A word of explanation about the notation is needed, and the diagrams are defined, although they are virtually self-explanatory.

Notation

- Syntactic elements are connected by lines with directional symbols to indicate the flow, which generally proceeds from left to right.
- Repeatable elements have a right-to-left reverse path shown above and around them, which can also contain a separator such as a comma. As far as possible, the commands for the 4950 have been simplified to avoid reverse paths.
- When it is possible to bypass elements, a left-to-right path is shown below and around them.
- When there is a choice of elements, the path branches to the choices.

The earlier example program message:

```
DCV{phs}10,PCent_100,REM_GUarD;
  TRIG_srce{phs}EXT;*TrG{NL}
```

is a syntactic string derived from the DCV, TRIG_SRCE and *TRG commands, which appear in the range of diagrams described below. {phs} means 'program header separator', described earlier.

Syntax Diagrams in this Handbook

The following paragraphs describe the syntax diagrams used in this handbook. Some repetition of earlier matter is inevitable, but at this point we are more concerned with the syntax diagrams.

Hierarchy of Syntactic Elements

All messages are subject to the protocols of addressing and handshake defined in the IEEE 488.1 Standard document. Within these protocols, messages are characterized by the presence of terminators, each of which seals the set of syntactic elements sent since the previous terminator to form a 'Program Message'.

The Program Message

Each Program Message may consist of only one syntactic element plus its terminator, or may be subdivided into many 'Program Message Units', separated by semi-colons (;) which are known as 'Program Message Unit Separators'. Thus the semi-colon cannot be used for any other purpose.

As you can see from the diagram, multiple Program Message Units can be sent if they are separated using semi-colons (shown in the repeat path). The block named 'Program Message Unit' therefore represents **either** repeats of the same unit, **or** a set of different units, **or** a mixture of both. The starting circle is a device used only for the diagram; there is no requirement to use a special character to start a message, providing the previous message was correctly terminated. It is possible to send only the terminator as a complete Program Message (as shown by the forward bypass path), but this feature has little use when programming the 4950.

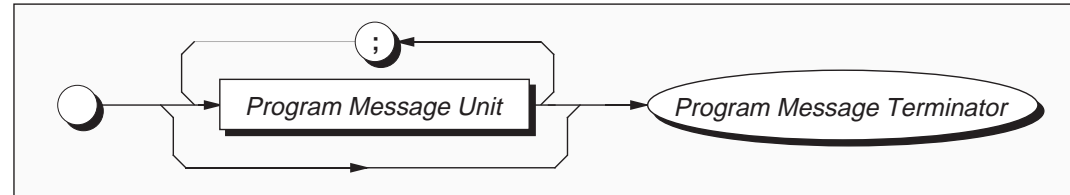
Syntax Diagram of a Simple Program Message**Character Usage**

Notice that the names of some elements are shown here in italics. This agrees with the convention used on the syntax diagrams in this handbook, which sets 'non-literal' text (names given to particular elements) in italics, whereas 'literal' text (the actual characters to be sent, such as the semi-colon in the diagram) is shown in plain-text capitals.

Upper/Lower Case Equivalence

The plain-text capitals are not demanded by the standard, and the 4950 will not differentiate between upper and lower case characters in literal program text. Either or both can be used, mixed upper and lower case if this conveys an advantage.

Numeric Representation

Several commands and queries used for the 4950 require transmission and reception of numbers. Decimal formats are generally used.

The IEEE 488.2 document specifies formats which ensure that a device is 'forgiving' when receiving program or query commands, but 'precise' when transmitting responses to queries.

For program data it insists that a device must accept the decimal 'Flexible Numeric Representation (*Nrf*)', which is a flexible version of three numeric representations (*Nr1*, *Nr2* and *Nr3*) defined by ANSI X3.42-1975 [2]. The 4950 complies.

Decimal numeric response data from the 4950 employs either *Nr1* or *Nr3* format, usage depending on the particular response. In this handbook, all syntax diagrams for query messages are accompanied by a paragraph which indicates the response format. Users are left in no doubt as to the construction of the response.

The Program Message Unit

Program Message Units (PMUs) can be 'Terminal' or 'Non-terminal'. The final PMU in any Program Message is always Terminal (includes the terminator), whereas all preceding

PMUs within the Program Message are obviously Non-terminal. Most of the commands in this handbook are described in the form of non-terminal message units:

Non-Terminal Program Message Unit

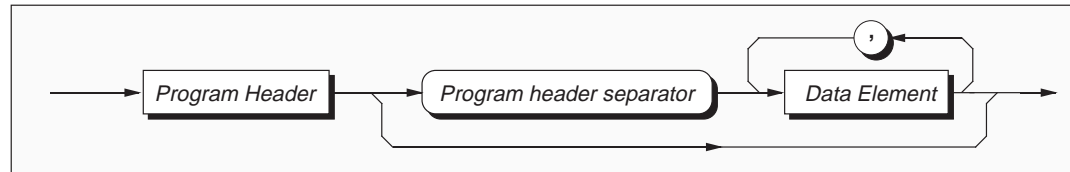

To save space, the name 'program header separator' is abbreviated to 'phs'.

Use of phs

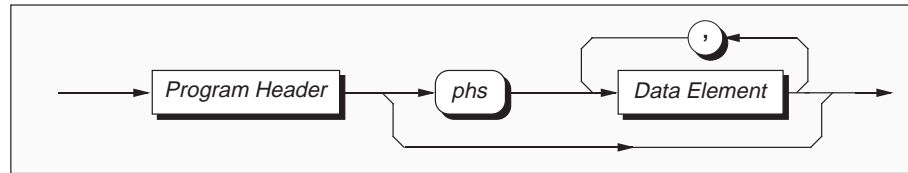

The Command Program Header

Several versions are defined by the IEEE 488.2 Standard document. The 'Simple', 'Common' and 'Query' headers are designed into the 4950, but not 'Compound' headers.

For example: the command for Confidence Selftest (*TST?) is shown in abbreviated, rather than full format:

The asterisk (Common) and question mark (Query) are defined separately by the standard document, but as they are inseparable from the command, they are shown on the 4950 syntax diagrams in the same block as the program mnemonic (abbreviated format).

Common Query - Abbreviated Format

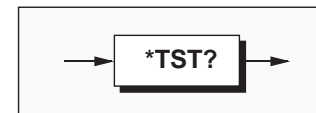

Program Data Elements

Four versions of the defined program data elements are employed. They are emphasized in the following syntax diagrams, which are examples from the list of commands available for the 4950:

Character

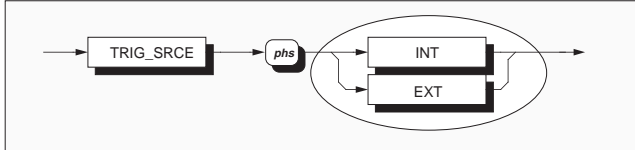

Decimal Numeric

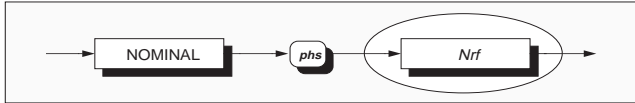

(Nrf can be expressed in any of the ways defined by the Standard document)

String

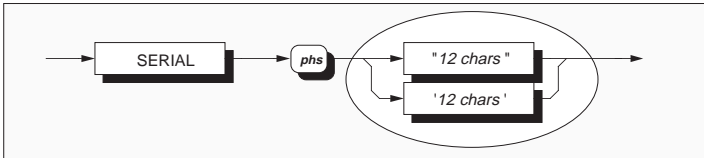

(The string size is defined)

Arbitrary Block Data Elements

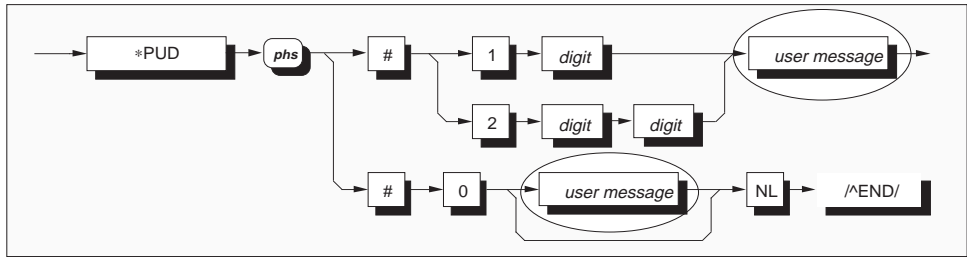

Both the 'Definite' and 'Indefinite' forms specified in the Standard document are used, as shown in the Syntax diagram. The *user message* must be limited to a maximum of 63 bytes.

The definite form can be fitted into a string of message units, but the indefinite form (lower path) has no exit to further message units. In this case the

program message must be terminated to inform the instrument that the block is complete.

Note that the slash-delimited /^END/ box is not outlined. This is to draw attention to the fact that it is not a data element, but represents the EOI line being set true with the last byte 'NL' to terminate the program message.

Message Exchange

IEEE 488.1 Model

The 4950 conforms to the requirements of the IEEE 488.1 Standard, in respect of the interactions between its device system interface and the system bus. Its conformance is described by the interface

capability codes listed in *Table 5.1* on *page 5-2*. In addition, the 4950 is adapted to the protocols described by the IEEE 488.2 model, as defined in that standard's specification.

IEEE 488.2 Model

The IEEE 488.2 Standard document illustrates its Message Exchange Control Interface model at the detail level required by the device designer. Much of the information at this level of interpretation (such as the details of the internal signal paths etc.) is transparent to the application programmer.

However, because each of the types of errors flagged in the Event Status Register are related to a particular stage in the process, a simplified 4950 interface model can provide helpful background. This is shown in *Fig. 5.2* opposite, with brief descriptions of the actions of its functional blocks.

4950 Message Exchange Model

Input/Output Control transfers messages from the 4950 output queue to the system bus; and conversely from the bus to either the input buffer, or other predetermined destinations within the device interface. Its interaction with the controller, via the system bus, is subject to the IEEE 488.1 management and handshake protocol.

It receives the Status Byte from the status reporting system, as well as the state of the request service bit which it imposes on bit 6 of the Status Byte (ultimately on bus line DIO 7) in the event of a serial poll. Bit 6 reflects the 'Request Service state *true*' condition of the interface.

Incoming Commands and Queries

The **Input Buffer** is a first in - first out queue, which has a maximum capacity of 128 bytes (characters). Each incoming character in the I/O Control generates an interrupt to the instrument processor which places it in the Input Buffer for examination by the Parser. The characters are removed from the buffer and translated with appropriate levels of syntax checking. If the rate of programming is too fast for the Parser or Execution Control, the buffer will progressively fill up. When the buffer is full, the handshake is held.

The **Parser** checks each incoming character and its message context for correct Standard-defined generic syntax, and correct device-defined syntax. Offending syntax is reported as a **Command Error**, by setting *true* bit 5 (CME) of the Standard-defined Event Status register, and placing an error description number in a queue associated with the CME bit. (refer to the sub-section 'Retrieval of Device Status Information').

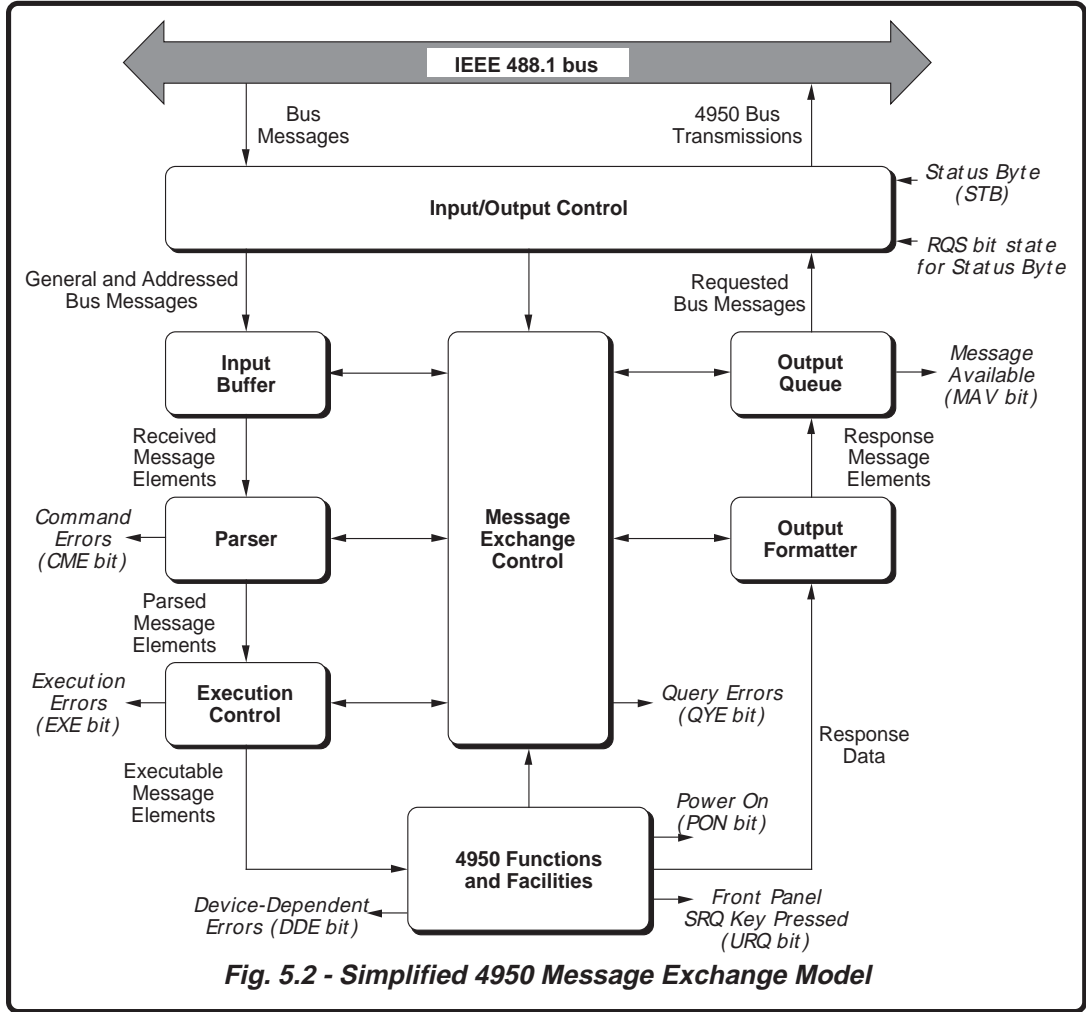

Fig. 5.2 - Simplified 4950 Message Exchange Model

Execution Control receives successfully parsed messages, and assesses whether they can be executed, given the currently-programmed state of the 4950 functions and facilities. If a message is not viable (eg the selftest common query: *TST? when calibration is successfully enabled); then an Execution Error is reported, by setting *true* bit 4 (EXE) of the Standard-defined Event Status

register, and placing an error description number in a queue associated with the EXE bit. Viable messages are executed in order; altering the 4950 functions, facilities etc. Execution does not 'overlap' commands; instead, the 4950 Execution Control processes all commands 'Sequentially' (ie. waits for actions resulting from the previous command to complete before executing the next).

4950 Functions and Facilities

The 4950 Functions and Facilities block contains all the device-specific functions and features of the 4950, accepting Executable Message Elements from Execution Control and performing the associated operations. It responds to any of the elements which are valid Query Requests (both IEEE 488.2 Common Query Commands and 4950 Device-specific Command Queries) by sending any required Response Data to the Output formatter (after carrying out the assigned internal operations).

Device-dependent errors are detected in this block. Bit 3 (DDE) of the Standard-defined Event Status register is set true when an internal operating fault is detected, for instance during a self test. Each reportable error has a listed number, which is appended to an associated queue as the error occurs.

This block also originates a local power-on message by the action of the 4950 line power being applied. Bit 7 (PON) of the Standard-defined Event Status register is set true when the instrument power transits from off to on (refer to the sub-section 'Retrieval of Device Status Information').

The front-panel **SRQ** key allows users to initiate an SRQ (providing the appropriate status register bits are enabled). Bit 6 (URQ) of the Standard-defined Event Status register is set true when the key is pressed, and set to false by reading the Event Status register or if the registers are cleared by *CLS.

Trigger Control

Two types of message are used to trigger the 4950 A-D into taking a measurement:

- GET** (IEEE 488.1-defined)
- *TRG** (IEEE 488.2-defined)

In the 4950 both GET and *TRG messages are passed through the Input Buffer, receiving the same treatment as program message units, being parsed and executed as normal.

Outgoing Responses

The **Output formatter** derives its information from Response Data (being supplied by the Functions and Facilities block) and valid Query Requests. From these it builds Response Message Elements, which are placed as a Response Message into the Output Queue.

The **Output Queue** acts as a store for outgoing messages until they are read over the system bus by the Controller. For as long as the output queue holds one or more bytes, it reports the fact by setting *true* bit 4 (Message Available - MAV) of the Status Byte register. Bit 4 is set *false* when the output queue is empty (refer to the sub-section 'Retrieval of Device Status Information').

Response Terminations

A single query sent as a terminated program message will elicit a single response terminated by:

nl = newline with EOI

If multiple queries are sent as a string of program message units (separated by semi-colons with the string followed by a permitted terminator), then the responses will be returned as a similar string whose sequence corresponds to the sequence of the program queries. The final response in the string will be followed by the terminator:

nl = newline with EOI

'Query Error'

This is an indication that the controller is following an inappropriate message exchange protocol, resulting in the following situations:

- **Interrupted Action.** When the 4950 has not finished outputting its **Response Message** to a **Program Query**, and is interrupted by a new **Program Message**.
- **Unterminated Action.** When the controller attempts to read a **Response Message** from the 4950 without having first sent the complete **Query Message** (including the **Program Message Terminator**) to the instrument.

The Standard document defines the 4950's response, part of which is to set *true* bit 2 (QYE) of the Standard-defined Event Status register.

Service Request (SRQ)

IEEE 488.1 Model

The IEEE 488.1 model provides for a separate line (SRQ line) on the system bus, to be set true (Low) by the device when requesting service from the controller. The model defines the subsequent action by the controller, and in the 4950 the *serial poll* facility has been incorporated.

The controller conducts a serial poll by requesting each participating device, in sequence, to write its Status Byte onto the DIO lines 8-1. In each response, the bit on the DIO 7 line (Request Service bit) indicates whether that was the device which originated the request for service.

Reasons for Requesting Service

There are two main reasons for the 4950 to request service from the controller:

- When the 4950 message exchange interface discovers a system programming error;
- When the 4950 is programmed to report significant events by SRQ.

The significant events vary between types of devices; thus there is a class of events which are known as 'Device-Specific'. These are determined by the device designer and included in the device operating program.

IEEE 488.2 Model

The application programmer can enable or disable the event(s) which are required to originate an SRQ at particular stages of the application program. The IEEE 488.2 model incorporates a flexible extended status reporting structure in which the requirements of the device designer and application programmer are both met.

This structure is described in the next sub-section, dealing with 'Retrieval of Device Status Information'. As SRQ provision is integral to the structure, the description of the implementation of SRQ features is covered in that sub-section rather than in this.

Retrieval of Device Status Information

Introduction

Need for Status Reporting

For any remotely-operated system, the provision of up-to-date information about the performance of the system is of major importance. This is particularly so in the case of systems which operate under automatic control, as the controller requires the necessary information feedback to enable it to progress the programmed task, and any break in the continuity of the process can have serious results.

When developing an application program, the programmer needs to test and revise it, knowing its effects. Confidence that the program elements are couched in the correct grammar and syntax (and that the program commands and queries are thus being accepted and acted upon), helps to reduce the number of iterations needed to confirm and develop the viability of the whole program. So any assistance which can be given in closing the information loop must benefit both program compilation and subsequent use.

The 4950 Status Reporting Structure

In a closely-specified Standard such as the IEEE 488.2, we should expect to find a well-defined and comprehensive status reporting facility, and this is indeed the case. Not only does the Standard establish regular methods of retrieving the information, but it also provides the means for the device designer to build a status-reporting structure which is pertinent to the nature of the device. Within this structure the application programmer is then given a wide choice to decide on the sort of information required at each stage in the program.

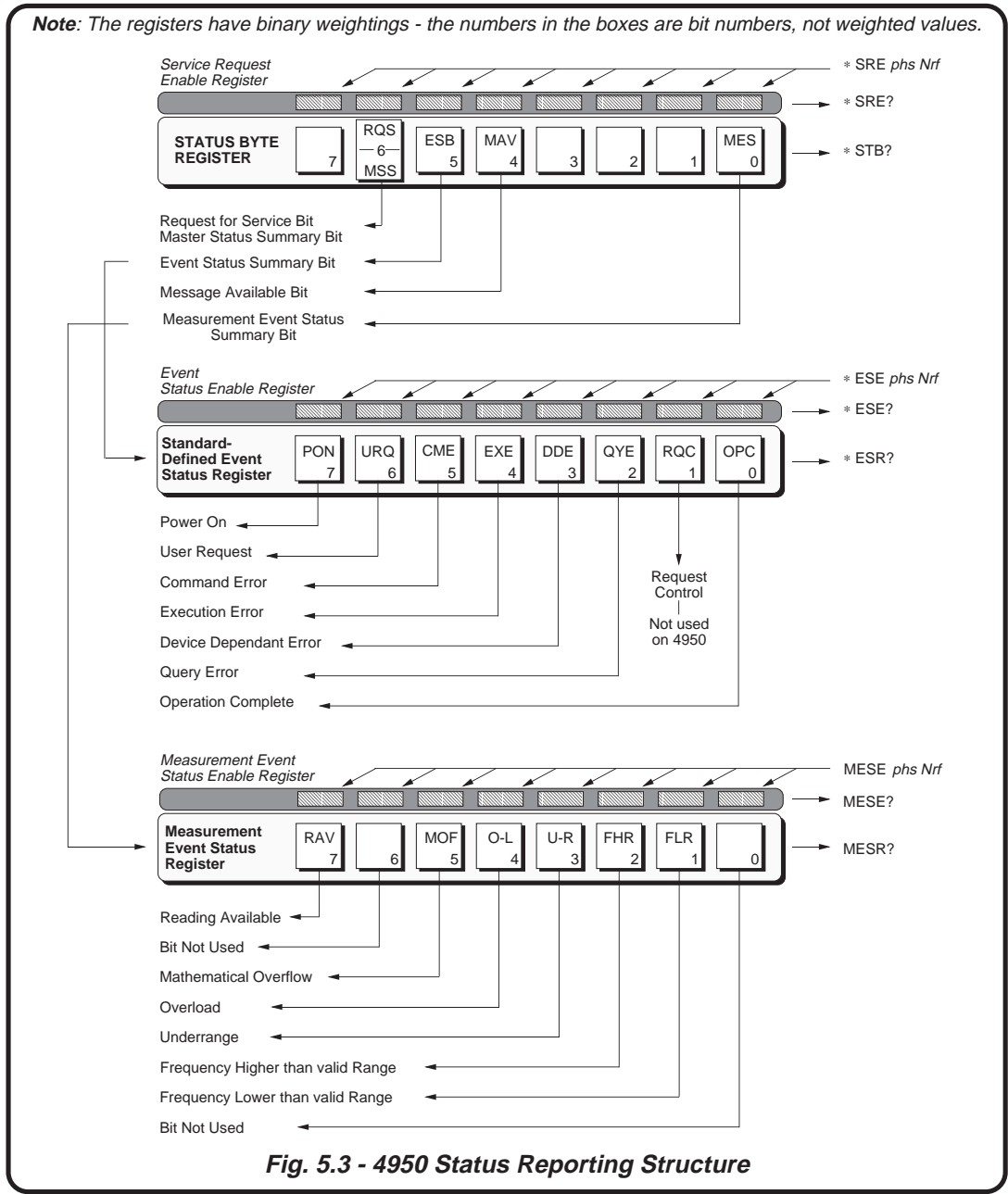

Standard-Defined and Device-Specific Features

In the 4950, the structure has been developed into three main registers (*Fig. 5.3*), as follows:

- **The ‘Status Byte Register’**
contains the ‘**Status Byte**’, which summarizes the remainder of the structure. Bits 6-4 are Standard-defined, but bits 3-0 and 7 are provided for the device designer to define.
- **The ‘Event Status Register’**
Defined by the standard, contains the ‘**Event Status Byte**’, whose component bits report Standard-defined types of events. This register is summarized by bit 5 in the Status Byte (ESB).

Each bit in the Event Status Byte can report a range of device-specific events. For these, the Standard requires the device designer to notify the user of the events which will cause each of the bits to be set. Section 4, Appendix A lists the 4950-specific events associated with the CME, EXE and DDE bits.

- **The ‘Measurement Event Status Register’**
Up to five Device-Specific Event Status Registers or queues can be defined by the device designer, to be associated with the available expansion summary bits 3-0 and 7 in the Status Byte.

In the 4950 only one register is defined, for the ‘**Measurement Event Status Byte**’, whose component *bits* are device-specific (ie. to the 4950). It uses summary bit 0 in the Status Byte (MES).

Access via the Application Program

The application designer has access to three enable registers (one for each main register - *Fig. 5.3*). The application program can enable or disable any individual bit in these registers.

Each bit in the two event status bytes remains in *false* condition unless its assigned event occurs, when its condition changes to *true*. If an event is to be reported, its corresponding bit in the enable byte will already have been set *true* by the application program, using the number *Nrf* (defined as a decimal numeric from 0 to 255 in any common format). Then when this event occurs and changes its event bit from *false* to *true*, the appropriate summary bit in the Status Byte (ESB or MES) is also set true. If this summary bit is also enabled, then the 4950 will generate an SRQ by causing the SRQ line on the system bus to be set *true* (low).

Thus the application programmer can decide which assigned events will generate an SRQ, by enabling their event bits and then enabling the appropriate summary bit(s) in the Status Byte. The controller can be programmed to read the Status Byte during a resulting serial poll, and be directed to the appropriate Event Register to discover which event was responsible for originating the SRQ. Only the Status Byte itself can be read *bitwise* on to the DIO lines of the system bus, and then only by the serial poll to which special conditions are attached.

Each of the six bytes can be read by a suitable query (*STB?, *ESR? or MESR? for the status and event bytes; *SRE?, *ESE?, or MESE? for the enable bytes). The result is presented as an ASCII decimal numeric which, when rounded and expressed in binary, reproduces the bit pattern in the register. This numeric form is also used to set the enabling registers to the required bit-patterns.

The detail of the data in each byte is related in the following paragraphs, and in the command descriptions.

Types of Status Information Available

Three main categories of information are provided for the controller:

Status Summary Information

Contained within the 'Status Register', the 'Status Byte' (STB) consists of flag bits which direct the controller's attention to the type of event which

has occurred. Four bits are employed in the 4950; these are described in detail later, but two ('ESB' and 'MES') appear in the following paragraphs.

Standard-defined events:

- Power On - the instrument line power has been switched on and the associated operational selftest has been completed successfully.
- User Request - the 'SRQ' key on the front panel has been pressed.
- Command Error - a received bus command does not satisfy the syntax rules programmed into the instrument interface's parser, and so is not recognized as a valid command.
- Execution Error - a received command has been successfully parsed, but it cannot be executed owing to the currently-programmed condition of the instrument.
- Device-Dependent Error - a reportable internal operating fault has been detected. This may be failure of a self-test.
- Query Error - the controller is following an inappropriate message exchange protocol, in attempting to read data from the output queue.
- Request Control - provided for devices which are able to assume the role of controller. This capability is not available in the 4950.
- Operation Complete - initiated by a message from the controller, indicates that the 4950 has completed all selected pending operations.

These events are flagged in the 8-bit latched 'Event Status Register' (ESR), read-accessible by the controller. The user's application program can also access its associated enabling register, to program the events which will be eligible to activate the ESB summary bit in the Status Byte.

Measurement events:

- When the instrument has been commanded to take a reading; the reading has been taken and is available to be read.
- Mathematical Overflow
- Overload
- Underrange
- Input frequency higher than the valid range
- Input frequency lower than the valid range

These events are flagged in another 8-bit latched register, called the 'Measurement Event Status Register' (MESR), which is read-accessible by the controller. The user's application program can also access its associated enabling register, to program the events which will be eligible to activate the MES summary bit in the Status Byte.

A Note about Queues

The MAV bit in the Status Byte summarizes the Output Queue. The CME, EXE and DDE bits in the Standard-Defined Event Status Byte) are associated with their own queues of events. These are all 'historical' (Last In - First Out) stacks to aid diagnosis of errors, and when the queue stack is full the eldest entries are discarded.

It is good practice to program the application to read any queue as soon as its associated or summary bit is set true, particularly the error bits, otherwise the original cause of the error can be discarded as subsequent *dependent* errors fill up the stack.

4950 Status Reporting - Detail

IEEE 488.1 Model

Provides for two major forms of status reporting:

- Device-specific commands from the controller, to generate status responses which have been previously programmed into the device to represent specific device conditions.
- Serial-polling of devices on the bus following a Service Request (the device pulling the SRQ line *true*).

The device anticipates that the controller will conduct a serial poll of devices on the bus as a result of the SRQ. So as it issues the SRQ, it sets up a 'Status Byte' for the controller to read.

If the controller is programmed to conduct a serial poll to identify the source of the SRQ, and subsequently read the 'Status Byte', the number represented by the byte can be interpreted as an event message. Such numbers are previously coded into the device's firmware to represent specific device conditions, and application programmers are thus able to program alarms or other actions to occur when such messages are received by the controller.

IEEE 488.2 Model

This incorporates the two aspects of the IEEE 488.1 model into an extended structure with more definite rules. These rules invoke the use of standard 'Common' messages and provide for device-dependent messages. A feature of the structure is the use of 'Event' registers, each with its own enabling register as illustrated in *Fig. 5.3*.

4950 Model Structure

The IEEE 488.2 Standard provides for a more extensive hierarchical structure with the Status Byte at the apex, defining its bits 4, 5 and 6 and their use as summaries of a *Standard*-defined event structure which **must** be included, if the device is to claim conformance with the Standard. The 4950 employs these bits as defined in the Standard.

Bits 0, 1, 2 and 3 and 7 of the Status Byte are made available to the device designer, to act as summaries of *device*-specific events. In the 4950, only bit 0 is necessary in order to summarize its device-specific events.

It must be recognized by the application programmer that whenever the controller reads the Status Byte, it can only receive summaries of types of events, and further query messages are necessary to dig deeper into the detailed information relating to the events themselves.

Thus two further bytes are used to expand on the summaries at bits 0 and 5 of the Status Byte.

Status Byte Register

In this structure the Status Byte is held in the 'Status Byte Register'; the bits being allocated in the 4950 as follows:

Bit 0 (DIO1) Device-specific Measurement Event Summary Bit (MES)

This summarizes the byte held in a Device-defined 'Measurement Event Status Register' (MESR), whose bits represent reportable conditions in the device. In the 4950 these are overload, math overflow, reading available, underrange, and input frequency outside the valid range. The MES bit is *true* when the byte in the MESR contains one or more enabled bits which are *true*; or *false* when all the enabled bits in the byte are *false*. The Measurement Event Status Register, its enabling register and byte are described later.

Bits 1 (DIO2), **2** (DIO3) and **3** (DIO4) are not used in the 4950 status byte. They are always *false*.

Bit 4 (DIO5) IEEE 488.2-defined Message Available Bit (MAV)

The MAV bit helps to synchronize information exchange with the controller. It is *true* when the 4950 message exchange interface is ready to accept a request from the controller to start outputting bytes from the Output Queue; or *false* when the Output Queue is empty.

The common command *CLS can clear the Output Queue, and the MAV bit 4 of the Status Byte Register; providing it is sent immediately following a 'Program Message Terminator'.

Bit 5 (DIO6) IEEE 488.2-defined Standard Event Summary Bit (ESB)

This summarizes the state of the 'Event Status byte', held in the 'Event Status register' (ESR), whose bits represent IEEE 488.2-defined conditions in the device. The ESB bit is *true* when the byte in the ESR contains one or more enabled bits which are *true*; or *false* when all the enabled bits in the byte are *false*. The byte, the Event Status Register and its enabling register are defined by the IEEE 488.1 Standard; they are described later.

Bit 6 (DIO7) This bit has a dual purpose:

When the controller is conducting a serial poll (as a result of receiving a Service Request via the SRQ line), the 4950 is placed into 'serial poll active state' and bit 6 is the Request Service Message (RQS bit). If the 4950 had been the device which originated the SRQ, its output control will set the DIO 7 line (bit 6's channel) *true*, but if not, then DIO 7 is set *false*. By reading the Status Byte *bitwise*, the controller identifies the device which originated the SRQ; and in the case of it being the 4950, also receives any enabled summary bits to allow further investigation of the originating event.

If the controller reads the Status Byte using the common query *STB?, then bit 6 is the Master Status Summary Message (MSS bit), and is set *true* if one of the bits 0 to 4 or bit 5 is *true* (bits 1 to 3 are always *false* in the 4950).

Bit 7 (DIO8) is not used in the 4950 status byte. It is always *false*.

Reading the Status Byte Register

There are two ways of reading the Status Byte register: by serial poll or by common query *STB?

Serial Poll

When the controller conducts a serial poll, the 4950 is placed into 'serial poll active state' by the IEEE 488.1 command SPE, and is addressed as a talker. The enabled contents of the Status Byte register are transferred in binary form into the 4950 I/O control, which sets the RQS bit 6 *true* if the 4950 had originated the preceding SRQ, or *false* if it had not. The binary values of bits 1, 2, 3 and 7 are always zero. The resulting byte is placed in binary onto the system bus on the corresponding DIO 8-1 lines. When the serial poll is disabled by the command SPD, the 4950 enters 'serial poll inactive state', and the I/O control relinquishes control of RQS bit 6 on the DIO 7 line.

***STB?**

The common query: *STB? reads the binary number in the Status Byte register. The response is in the form of a decimal number which is the sum of the binary weighted values in the enabled bits of the register. In the 4950, the binary-weighted values of bits 1, 2, 3 and 7 are always zero. The query *STB? is provided mainly for controllers with no serial poll capability, and for those users who are using the device interface for RS232-type communication.

Service Request Enable Register

The SRE register is a means for the application program to select those types of events which are to cause the 4950 to originate an SRQ, by enabling individual Status Byte summary bits. The register contains a user-modifiable image of the Status Byte, whereby each *true* bit acts to enable its corresponding bit in the Status Byte.

Bit Selector: *SRE *phs Nrf*

The program command: *SRE *phs Nrf* performs the selection, where *Nrf* is a decimal numeric, which when decoded into binary produces the required bit-pattern in the enabling byte.

For example:

If an SRQ is required only when a Standard-defined event occurs and when a message is available in the output queue, then *Nrf* should be set to 48. The binary decode is 00110000 so bit 4 or bit 5, when *true*, will generate an SRQ; but even when bit 0 or bit 6 is *true*, no SRQ will result. The 4950 always sets the Status Byte bits 1, 2, 3 and 7 *false*, so they can never originate an SRQ whether enabled or not.

Reading the Service Request Enable Register

The common query: *SRE? reads the binary number in the SRE register. The response is in the form of a decimal number which is the sum of the binary-weighted values in the register. The binary-weighted values of bits 1, 2, 3 and 7 are always zero.

IEEE 488.2-defined Event Status Register

The 'Event Status Register' holds the Event Status Byte, consisting of event bits, each of which directs attention to particular information. All bits are 'sticky'; ie. once *true*, cannot return to *false* until the register is cleared. This occurs automatically when it is read by the query: *ESR?. The common command *CLS clears the Event Status Register and associated error queues, but not the Event Status Enable Register. The bits are named in mnemonic form as follows:

Bit 0 Operation Complete (OPC)

This bit is *true* only if *OPC has been programmed *and* all selected pending operations are complete. As the 4950 operates in serial mode, its usefulness is limited to registering the completion of long operations, such as self-test.

Bit 1 Request Control (RQC)

This bit would be *true* if the device was able to assume the role of controller, *and* was requesting that control be transferred to it from the current controller. This capability is not available in the 4950, so bit 1 is always *false*.

Bit 2 Query Error (QYE)

QYE *true* indicates that an attempt is being made to read data from the output queue when no output is present or pending, or data in the output queue has been lost. The Standard document defines the conditions under which a query error is generated, as a result of the controller failing to follow the message exchange protocol.

Bit 3 Device Dependent Error (DDE)

DDE is set *true* when an internal operating fault is detected, for instance during a self test. Each reportable error has been given a listed number, which is appended to an associated queue as the

error occurs. The queue is read destructively as a Last In First Out stack, using the query command DDQ? to obtain a code number. The DDE bit is not a summary of the contents of the queue, but is set or confirmed *true* concurrent with each error as it occurs; and once cleared by *ESR? will remain *false* until another error occurs. The query DDQ? can be used to read all the errors in the queue until it is empty, when the code number zero will be returned.

The common command *CLS clears the queue.

Bit 4 Execution Error (EXE)

An execution error is generated if the received command cannot be executed, owing to the device state or the command parameter being out of bounds. Each reportable execution error has been given a listed number, which is appended to an associated queue as the error occurs. The queue is read destructively as a Last In First Out stack, using the query command EXQ?. The EXE bit is not a summary of the contents of the queue, but is asserted *true* as each error occurs; and once cleared by *ESR? will remain *false* until another error occurs. The query EXQ? can be used to read all the errors in the queue until it is empty, when the code number zero will be returned.

The common command *CLS clears the queue.

Bit 5 Command Error (CME)

CME occurs when a received bus command does not satisfy the IEEE 488.2 generic syntax or the device command syntax programmed into the instrument interface's parser, and so is not recognized as a valid command. Each reportable execution error has been given a listed number, which is appended to an associated queue as the error occurs. The queue is read destructively as a

Last In First Out stack, using the query command CMQ?. The CME bit is not a summary of the contents of the queue, but is asserted *true* as each error occurs; and once cleared by *ESR? will remain *false* until another error occurs. The query CMQ? can be used to read all the errors in the queue until it is empty, when the code number zero will be returned.

The common command *CLS clears the queue.

Bit 6 User Request (URQ)

This bit is set *true* by the action of pressing the front panel SRQ key. If the URQ bit and the ESB bit are enabled, an SRQ is generated and the SRQ legend on the main display lights. During a subsequent serial poll the controller reads the Status Byte, the RQS bit in the I/O control is destroyed, and the front panel legend is extinguished. The ESB and URQ bits remain *true*, returning to *false* when the controller destructively reads the Event Status register by *ESR?, or clears status by *CLS.

Bit 7 4950 Power Supply On (PON)

This bit is set *true* only when the Line Power has just been switched on to the 4950, and the subsequent Operational Selftest has been completed successfully (if unsuccessful, the DDE bit 3 is set true, generating an SRQ if its enable bit is also set true). Whether this generates an SRQ or not is dependent on the decimal numeric value previously programmed as part of the 'Power On Status Clear' message *PSC *phs Nrf*. If *Nrf* was 1, the Event Status Enable register would have been cleared at power on, so PON would not generate the ESB bit in the Status Byte register, and no SRQ would occur at power on. For an *Nrf* of zero, **and** the Event Status Enabling register bit 7 *true*, **and**

the Service Request Enabling register bit 5 *true*; a change from Power Off to Power On generates an SRQ. This is only possible because the enabling register conditions are held in non-volatile memory, and restored at power on.

This facility is included to allow the application program to set up conditions so that a momentary Power Off followed by reversion to Power On (which could upset the 4950 programming) will be reported by SRQ. To achieve this, the Event Status register bit 7 must be set permanently *true* (by *ESE *phs Nrf*, where $Nrf \geq 128$); the Status Byte Enable register bit 5 must be set permanently *true* (by command *SRE *phs Nrf*, where $Nrf \geq 32$); Power On Status Clear must be disabled (by *PSC *phs Nrf*, where $Nrf = 0$); and the Event Status register must be read destructively immediately following the Power On SRQ (by the common query *ESR?).

Standard Event Status Enable Register

The ESE register is a means for the application program to select, from the positions of the bits in the standard-defined Event Status Byte, those events which when *true* will set the ESB bit *true* in the Status Byte. It contains a user-modifiable image of the standard Event Status Byte, whereby each *true* bit acts to enable its corresponding bit in the standard Event Status Byte.

Continued Overleaf →

Standard Event Status Enable Register (Contd.)**Bit Selector: *ESE *phs Nrf***

The program command: *ESE *phs Nrf* performs the selection, where *Nrf* is a decimal numeric, which when decoded into binary, produces the required bit-pattern in the enabling byte.

For example:

If the ESB bit is required to be set *true* only when an execution or device-dependent error occurs, then *Nrfs* should be set to 24. The binary

decode is 00011000 so bit 3 or bit 4, when *true*, will set the ESB bit *true*; but when only bits 0-2, or 5-7 are *true*, the ESB bit will remain *false*.

Reading the Standard Event Enable Register

The common query: *ESE? reads the binary number in the ESE register. The response is in the form of a decimal number which is the sum of the binary-weighted values in the register.

Measurement Event Status Register

In this structure a 'Measurement Event Status Register' holds the Measurement Event Status Byte, consisting of event bits, specific to the 4950. All bits are 'sticky'; ie. once *true*, can return to *false* only when the register is cleared. This register is automatically cleared when it is read by the query: MESR?. The common command *CLS clears the Measurement Event Status Register but not the Measurement Event Status Enable Register.

Each of the bits is named in mnemonic form; they are described below:

Bit 0 Bit 0 is not allocated.

Bit 1 Frequency Lower than Valid Range (FLR)
Bit 1 is asserted *true* in ACV or ACI whenever an AC input signal has a frequency below the selected frequency band lower limit. The value recalled by the query: RDG? is $\pm 200.0000E+33$.

Bit 2 Frequency Higher than Valid Range (FHR)

Bit 2 is asserted *true* in ACV or ACI whenever an AC input signal has a frequency above the selected frequency band upper limit. The value recalled by the query: RDG? is $\pm 200.0000E+33$.

Bit 3 Underload (U-L)

Bit 3 is asserted *true* whenever an input signal has a value smaller than the selected measurement band lower limit. The value recalled by the query: RDG? is $\pm 200.0000E+33$.

Bit 4 Overload (O-L)

Bit 4 is asserted *true* whenever an input signal has a value greater than the selected measurement band upper limit. The value recalled by the query: RDG? is $\pm 200.0000E+33$.

Bit 5 Mathematical Overflow (MOF)

Bit 5 is asserted *true* whenever the modulus of the result of an internal math calculation has a value which is too large to be represented. The value recalled by the query: RDG? is $\pm 200.0000E+33$.

Bit 6 Bit 6 is not allocated.

Bit 7 Reading Available (RAV).

Bit 7 is asserted *true* whenever the result of a reading is available (when the A-D cycle is completed). If command RDG? is sent, the result will be placed in the output queue.

**Measurement Event Status
Enable Register**

The application program uses the MESE register to select, from the positions of the bits in the Measurement Event Status Byte, those events which when *true* will assert the MES bit *true* in the Status Byte. It contains a user-modifiable image of the Measurement Event Status Byte, whereby each *true* bit acts to enable its corresponding bit in the Measurement Event Status Byte.

Bit Selector: MESE *phs Nrf*

The program command: MESE *phs Nrf* performs the selection, where *Nrf* is a decimal numeric, which when decoded into binary, produces the required bit-pattern in the enabling byte.

For example:

If the MES bit is required to be asserted *true* only when the frequency is higher or lower than its valid band, then the value of *Nrf* should be set to 6. The binary decode is 00000110 so bit 1 or bit 2, when *true*, will assert the MES bit *true*; but when only bits 0 or 3-7 are *true*, the MES bit will not be asserted.

**Reading the
Measurement Event Status Enable Register**

The device-specific query: MESE? reads the binary number in the MESE register. The response is in the form of a decimal number which is the sum of the binary-weighted values in the register. The binary-weighted values of bits 0 and 6 are always zero.

4950 COMMANDS AND QUERIES - Syntax Diagrams

MEASUREMENT DEFINITION - MAJOR FUNCTIONS

DC Voltage

N.B. The number of readings to be taken in each DCV measurement sample, and hence the measurement resolution, depend on the current 'Accuracy' setting. This must be set to 'High' or 'Low' as required *before* the Trigger command is sent. Refer to "Calculations and Facilities" on the opposite page.

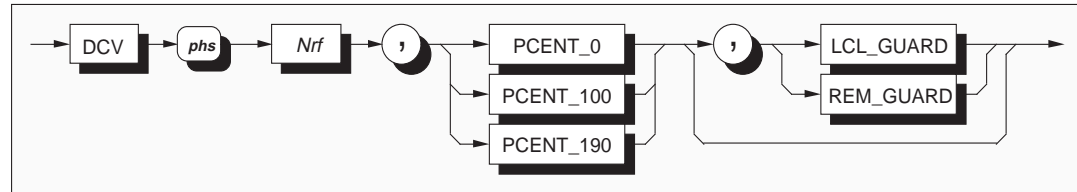

Nrf is a decimal numeric value.

It is intended to represent the most relevant range for the expected input signal. It is recommended that *Nrf* be given the nominal full range value.

The *Nrf* limits for range selection are shown in the list below.

	$0 \leq Nrf \leq 0.199999999$	100mV range
	$0.2 \leq Nrf \leq 1.999999999$	1V range
	$2.0 \leq Nrf \leq 19.999999999$	10V range
	$20 \leq Nrf \leq 199.999999999$	100V range
	$200 \leq Nrf $	1000V range

Measurement Band Selection

PCENT_0: selects the **zero** (0%) band:
0V \pm 10% FR (15% on 100mV range).

PCENT_100: selects the **full range** (100%) band:
Nominal \pm 10% (15% on 100mV range).

PCENT_190: selects the **High** (190%) measurement band on the 10V Range only:
+18V to +19.5V and -19.5 to -18V

Measurement Band Limits - Error Messages

Upper Limit:

If the magnitude of a measured signal is greater than the selected measurement band upper limit, then the message 'Error OL' appears on the main display of the front panel. A relevant query command (e.g. RDG?) invokes the 'invalid number response' and the 'O-L' bit 4 is set in the Measurement Event Status Register.

Lower Limit:

If the magnitude of a measured signal is less than the selected measurement band lower limit, then 'Error UL' appears on the main display of the front panel. A relevant query command (e.g. RDG?) invokes the 'invalid number response' and the 'U-L' bit 3 is set in the Measurement Event Status Register.

Partial Execution

For errors occurring in data elements within bypass routes (e.g. Guard controls) the command will be executed up to the start point of the bypass.

Optional Selection - Guard Connection

LCL_GUARD: selects Local Guard.

REM_GUARD: selects Remote Guard.

Calculations and Facilities

When in DCV ranges, the following facilities are available:

ACCURACY: Refer to 'Measurement Samples' and 'Measurement Resolution' below; and to *Page 5-39*.

ZERO?: Refer to 'Input Zero' below; and to *Page 5-44*.

DEVTN?: Refer to *Page 5-48*.

Measurement Samples

DCV measurements do not consist only of single readings. Each 'Measurement' derives from a single trigger, which generates a number of internal A-D conversions (sample) for the same input. The measurement result is the arithmetic mean of the sample. The sample size is determined by the Range and Accuracy selections as follows:

Range	Sample Size	
	(Low Acc.)	(High Acc.)
100mV	4	128
1V-1000V	4	64

Time should be allowed for these readings to be taken, after sending the trigger to start the sample.

Measurement Resolution

The resolution of the measurement is determined by the selected range and accuracy as follows:

Low Accuracy selected: 6.5 digits.

High Accuracy selected: 7.5 digits.

Recall of Measured Value

The RDG? query (page 5-46) recalls the value of the measurement (the arithmetic mean of the most-recent sample of readings).

Range Change within DCV Function

The active Measurement Band and Guard selections are saved, then re-activated on reselection of the range.

Note: In remote operation, the saved band selection will be overwritten as it is mandatory to specify the required band when changing range. This 'save' facility is included only for local operation where it is more intuitive and efficient to select range and band separately.

Exit from DCV Function

The active Range, Band and Guard selections are saved on exit and re-activated on re-entry.

Reversion from Remote to Local

No Change.

Execution Errors

1026 Illegal band selection.

Power On and Reset Conditions

DCV	Active (Internal State)
Range	1000
Band	Zero
Guard	Local
Mode	High Accuracy
Trigger	External

Input Zero: ZERO? Command (*page 5-44*)

When in any DCV range, in the zero band and with High Accuracy selected, the ZERO? command can be used to initiate an input zero measurement. The analog zero input must be applied externally.

The input zero measurement is carried out under the same conditions of resolution and sample size as the function/range in which it is commanded. The resulting error derives an offset correction.

The 4950 saves the correction in non-volatile RAM, then applies it in all subsequent measurements made on the same DCV range, until it is again measured on that range by another ZERO? command.

This facility can be used to nullify the effects of input source offsets up to the limits of the zero band (a total of $\pm 10\%$ of the nominal range value).

MEASUREMENT DEFINITION - MAJOR FUNCTIONS (Contd.)

AC Voltage

N.B. The number of readings to be taken in each ACV measurement sample, and hence the measurement resolution, depend on the current 'Accuracy' setting. This must be set to 'High' or 'Low' as required *before* the Trigger command is sent. Refer to "Calculations and Facilities" on the opposite page.

The following commands are used to select ACV function along with its associated configuration.

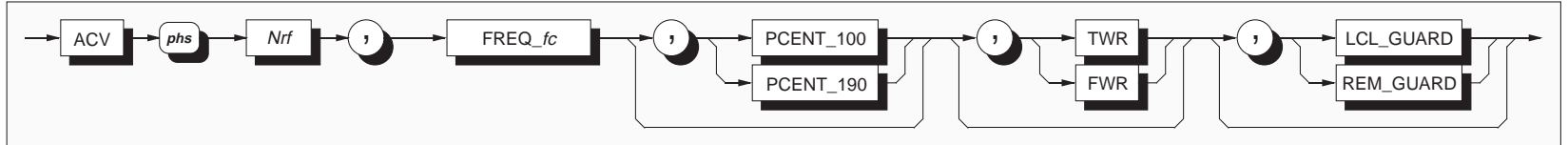

Nrf is a decimal numeric value, representing the most relevant range for the expected input signal. It is recommended that *Nrf* be given the nominal full range value. The *Nrf* limits for range selection are shown in the list below.

$0 \leq Nrf \leq 0.0019999$	1mV range
$0.002 \leq Nrf \leq 0.0199999$	10mV range
$0.02 \leq Nrf \leq 0.1999999$	100mV range
$0.2 \leq Nrf \leq 1.999999$	1V range
$2 \leq Nrf \leq 19.99999$	10V range
$20 \leq Nrf \leq 199.9999$	100V range
$200 \leq Nrf $	1000V range

Frequency Band Selection - FREQ_fc

FREQ_fc selects the frequency band, whose limits lie at $\pm 10\%$ of its center frequency, *fc*Hz. The characters to be used for *fc* are shown in the table:

Frequency Band Availability (for PCENT_100)

The table shows the allocation of frequency bands to ranges (for the **Full Range** measurement band only).

Frequency Band Availability (for PCENT_190)

The **10V** range **1K** band is the only frequency band available for the optional **High (PCENT_190)** Measurement Band.

Available Frequency Range/Band Combinations

Freq. Band Center <i>fc</i> (Hz)	AC Voltage Range						
	1mV*	10mV*	100mV*	1V	10V	100V	1kV
10	*	*	*	*	*	*	*
20	*	*	*	*	*	*	*
30	*	*	*	*	*	*	*
40	*	*	*	*	*	*	*
55†	*	*	*	*	*	*	*
300‡	*	*	*	*	*	*	*
1k	*	*	*	*	*	*	*
10k	*	*	*	*	*	*	*
20k	*	*	*	*	*	*	*
30k	*	*	*	*	*	*	*
50k	*	*	*	*	*	*	◆
100k	*	*	*	*	*	*	◆
200k						*	
300k	*	*	*	*	*		
500k	*	*	*	*	*		
1M	*	*	*	*	*		

† The 55Hz and 300Hz Frequency bands are extended to include prominent line power frequencies of 50Hz, 60Hz and 400Hz.

◆ 50kHz & 100kHz bands at 700V, not 1kV.

* For the millivolt ranges, in all frequency bands: voltage measurement bands are $\pm 15\%$, not $\pm 10\%$.

Refer to Section 4, page 4-10.

Frequency Band Limits - Error Messages

Higher Limit:

If the measured frequency of a signal exceeds the selected frequency band higher limit, then the message 'Error HF' appears on the main display of the front panel. A relevant query command (e.g. FREQ?) invokes the 'invalid number response', and the 'FHR' bit 2 is set in the Measurement Event Status Register.

Lower Limit:

If the frequency of a measured signal is less than the selected frequency band lower limit, then 'Error LF' appears on the main display of the front panel. A relevant query command (e.g. FREQ?) invokes the 'invalid number response', and the 'FLR' bit 1 is set in the Measurement Event Status Register.

Linked Error Reporting

The *frequency* is also reported as invalid if the signal *voltage* is outside the fixed band limits.

Partial Execution

For errors occurring in data elements within bypass routes (e.g. Guard controls) the command will be executed up to the start point of the bypass.

Optional Selection - Measurement Bands

PCENT_100: selects the **Full Range** band.
Nominal $\pm 10\%$ (15% on millivolt ranges).

PCENT_190: selects the **190%** band if on **10V Range** only.

Band span: 18V to 19.5V (19V; +5%FR, -10%FR).
This selection causes the instrument to revert to the **1kHz** frequency band.

No Selection: If the measurement band data element is omitted (as shown by the bypass), then the instrument reverts to the **Full Range** band.

Measurement Band Limits - Error Messages

Upper Limit:

If the magnitude of a signal exceeds the selected measurement band upper limit, then the message 'Error OL' appears on the main display of the front panel. A relevant query command (e.g. RDG?) invokes the 'invalid number response'; the 'O-L' bit 4 is set in the Measurement Event Status Register.

Lower Limit:

If the magnitude of a signal is below the selected measurement band lower limit, then 'Error UL' appears on the main display of the front panel. A relevant query command (e.g. RDG?) invokes the 'invalid number response', and the 'U-R' bit 3 is set in the Measurement Event Status Register.

Optional Selection - Guard Connections

LCL_GUARD: selects Local Guard.

REM_GUARD: selects Remote Guard.

Optional Selection - Two Wire or Four Wire Connection

TWR: connects the measurement terminals for two-wire measurement. For TWR to be accepted, the voltage range must be 1V or 10V, and the frequency band must be higher than 100kHz.

FWR: connects the measurement terminals for four-wire measurement. This is the default following any change to the measurement band.

Calculations and Facilities

When in ACV ranges, the following facilities are available:

ACCURACY: Refer to 'Measurement Samples' and 'Measurement Resolution' below; and to *Page 5-39*.

DEVTN?. Refer to *Page 5-48*

Measurement Samples

ACV measurements do not consist only of single readings. Each 'Measurement' derives from a single trigger, which generates a number of internal A-D conversions (sample) for the same input. The measurement result is the arithmetic mean of the sample. The sample size is determined by the Range and Accuracy selections as follows:

Accuracy	Range	Sample Size
High	All Ranges	8
Low	All Ranges	1

Time should be allowed for these readings to be taken, after sending the trigger to start the sample.

Measurement Resolution

The resolution of the measurement is determined by the selected range and accuracy as shown on the table in the next column →

Recall of Measured Value

The RDG? command (*page 5-46*) recalls the value of the measurement.

Other Conditions

Range Change within ACV Function

The active Band and Guard selections are saved and restored where appropriate.

Note: In remote operation, the saved band selection will be overwritten as it is mandatory to specify the required band when changing range. This 'save' facility is included only for local operation where it is more intuitive and efficient to select range and band separately.

Exit from ACV Function

The active Range, Band and Guard selections are saved on exit and restored on reselection of ACV function.

Reversion from Remote to Local

No Change.

Execution Errors

1026 Illegal band selection.

Power On and Reset Conditions

ACV Function	Inactive
Range	1000
Frequency Band	1kHz
Guard	Local
Mode	High Accuracy
Trigger	External

Range	Resolution (digits)	
	(Low Acc.)	(High Acc.)
1mV	4.5	5.5
10mV-1000V	5.5	6.5

MEASUREMENT DEFINITION - MAJOR FUNCTIONS (Contd.)

Resistance

N.B. The number of readings to be taken in each Ohms measurement sample, and hence the measurement resolution, depend on the current 'Accuracy' setting. This must be set to 'High' or 'Low' as required *before* the Trigger command is sent. Refer to "Calculations and Facilities' on the opposite page. The following commands are used to select Ohms function along with its associated configuration.

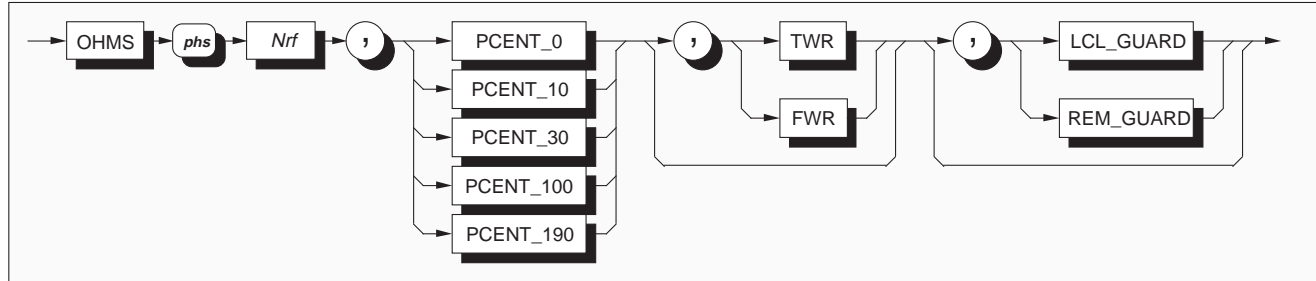

Nrf is a decimal numeric value.

It is intended to represent the expected signal amplitude, so that the instrument will go to the most relevant range. It is recommended that *Nrf* be given the nominal full range value.

The *Nrf* limits for range selection are shown in the list below:

$2 \leq Nrf \leq 19.9999999$	10 Ω range
$20 \leq Nrf \leq 199.999999$	100 Ω range
$200 \leq Nrf \leq 1999.99999$	1k Ω range
$2000 \leq Nrf \leq 19999.9999$	10k Ω range
$20000 \leq Nrf \leq 199999.999$	100k Ω range
$200000 \leq Nrf \leq 1999999.99$	1M Ω range
$2000000 \leq Nrf \leq 19999999.9$	10M Ω range
$20000000 \leq Nrf \leq 199999999$	100M Ω range

Measurement Band Selection

PCENT_0:	selects the zero band:	0 Ω to +10%FR.
PCENT_10:	selects the band at 10% of nominal (10 Ω Range only):	0.1 x FR \pm 10%FR.
PCENT_30:	selects the band at 30% of nominal:	0.3 x FR \pm 10%FR.
PCENT_100:	selects the full range band:	FR \pm 10%FR.
PCENT_190:	selects the band at 190% of nominal (Not 100M Ω Range):	1.9 x FR -10%FR, +5%FR.

Error Messages

Measurement Band Limits:

If the magnitude of a measured signal is not within the selected measurement band limits, then an error message appears on the main display of the front panel. A relevant query command (e.g. RDG?) invokes the 'invalid number response', and the relevant bit is set in the Measurement Event Status Register. This is summarized as follows:

Input Signal Magnitude	Main Display Indication	MESR Bit Set
Greater than Upper Limit	Error OL	Bit 4 (O-L)
Smaller than Lower Limit	Error UL	Bit 3 (U-L)

Partial Execution

For errors occurring in data elements within bypass routes (e.g. Guard controls) the command will be executed up to the start point of the bypass.

Optional Selection - Two Wire or Four Wire Connection

TWR: connects the measurement terminals for two-wire measurement. For TWR to be accepted, the lead serial no. must have been entered. Refer to *Page 5-54*.

FWR: connects the measurement terminals for four-wire measurement.

Optional Selection - Guard Connection

LCL_GUARD: selects Local Guard.

REM_GUARD: selects Remote Guard.

Calculations and Facilities

When in Ohms ranges, the following facilities are available:

ACCURACY: Refer to 'Measurement Samples' and 'Measurement Resolution' below; and to *Page 5-39*.

ZERO?: Refer to 'Input Zero' opposite; and to *Page 5-44*.

DEVTN?: Refer to *Page 5-48*.

Measurement Samples

Ohms measurements do not consist only of single readings. Each 'Measurement' derives from a single trigger, which generates a number of internal A-D conversions (sample) for the same input. The measurement result is the arithmetic mean of the sample. The sample size is determined by the Range and Accuracy selections as follows:

Range	Sample Size	
	(Low Acc.)	(High Acc.)
10Ω	4	128
100Ω-1MΩ	4	64
10MΩ & 100MΩ	4	128

Time should be allowed for these readings to be taken, after sending the trigger to start the sample.

Measurement Resolution

The resolution of the measurement is determined by the selected range and accuracy as follows:

Low Accuracy selected: 6.5 digits.

High Accuracy selected: 7.5 digits.

Recall of Measured Value

The RDG? command (*page 5-46*) recalls the value of the measurement (the arithmetic mean of the most-recent sample of readings).

Range Change within Ohms Function

The active Measurement Band and Guard selections are saved, then restored on reselection of the range.

Note: In remote operation, the saved band selection will be overwritten as it is mandatory to specify the required band when changing range. This 'save' facility is included only for local operation where it is more intuitive and efficient to select range and band separately.

Exit from Ohms Function

The active selections of Range, Band, 2/4-wire and Guard are saved on exit and restored on re-entry.

Reversion from Remote to Local

No Change.

Execution Errors

1026 Illegal band selection.

1032 2w ohms selection requires lead serial number.

1033 Lead serial number incorrect.

Power On and Reset Conditions

Ohms	Not Active (DCV Active)
Range	10MΩ
Band	Zero
Guard	Local
Mode	High Accuracy
Trigger	External

Input Zero: ZERO? Command (*page 5-44*)

When in any Ohms range, in the zero band and with High Accuracy selected, the ZERO? command can be used to initiate an input zero measurement. The analog zero input must be applied externally.

The input zero measurement is carried out under the same conditions of resolution and sample size as the function/range in which it is commanded. The resulting error derives an offset correction.

The 4950 saves the correction in non-volatile RAM, then applies it in all subsequent measurements made on the same Ohms range, until it is again measured on that range by another ZERO? command.

This facility can be used to nullify the effects of input source offsets up to the limits of the zero band (a total of $\pm 10\%$ of the nominal range value).

MEASUREMENT DEFINITION - MAJOR FUNCTIONS (Contd.)

DC Current

N.B. The number of readings to be taken in each DCI measurement sample, and hence the measurement resolution, depend on the selected 'Accuracy'. This must be set to 'High' or 'Low' as required *before* the Trigger command is sent. Refer to 'Calculations and Facilities' on the opposite page.

The following commands are used to select DCI function along with its associated configuration.

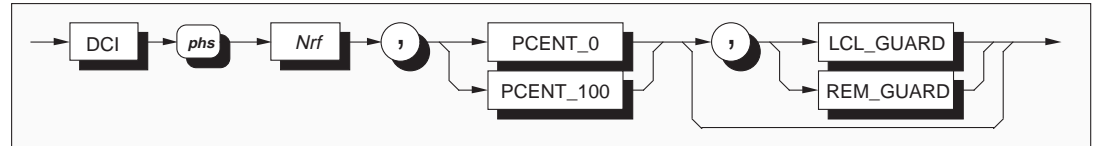

Nrf is a decimal numeric value.

It is intended to represent the expected signal amplitude, so that the instrument will go to the most relevant range. It is recommended that *Nrf* be given the nominal full range value.

The *Nrf* limits for nominal range selection are shown in the list below.

$0.00002 \leq Nrf \leq 0.000199$	100 μ A range
$0.0002 \leq Nrf \leq 0.001999$	1mA range
$0.002 \leq Nrf \leq 0.019999$	10mA range
$0.02 \leq Nrf \leq 0.199999$	100mA range
$0.2 \leq Nrf \leq 1.999999$	1A range
$2 \leq Nrf \leq 19.99999$	10A range

Note that the 10A range cannot be selected unless the shunt serial number has been entered.

Refer to *Page 5-52*.

Measurement Band Selection

PCENT_0: selects the **zero** band:
0A \pm 10% of Full Range.

PCENT_100: selects the **full range** band:
Nominal \pm 10%FR.

Measurement Band Limits - Error Messages

Upper Limit:

If the magnitude of a measured signal is greater than the selected measurement band upper limit, then the message 'Error OL' appears on the main display of the front panel. A relevant query command (e.g. RDG?) invokes the 'invalid number response'; the 'O-L' bit 4 is set in the Measurement Event Status Register.

Lower Limit:

If the magnitude of a measured signal is less than the selected measurement band lower limit, then 'Error UL' appears on the main display of the front panel. A relevant query command (e.g. RDG?) invokes the 'invalid number response'; the 'U-R' bit 3 is set in the Measurement Event Status Register.

Partial Execution

For errors occurring in data elements within bypass routes (e.g. Guard controls) the command will be executed up to the start point of the bypass.

Optional Selection - Guard Connection

LCL_GUARD: selects Local Guard.

REM_GUARD: selects Remote Guard.

Calculations and Facilities

When in DCI ranges, the following facilities are available:

ACCURACY: Refer to 'Measurement Samples' and 'Measurement Resolution' below; and to *Page 5-39*.

ZERO?: Refer to 'Input Zero' opposite; and to *Page 5-44*.

DEVTN?: Refer to *Page 5-48*.

Measurement Samples

DCI measurements do not consist only of single readings. Each 'Measurement' derives from a single trigger, which generates a number of internal A-D conversions (sample) for the same input. The measurement result is the arithmetic mean of the sample. The sample size is determined by the Range and Accuracy selections as follows:

Range	Sample Size	
	(Low Acc.)	(High Acc.)
All Ranges	1	32

Time should be allowed for these readings to be taken, after sending the trigger to start the sample.

Measurement Resolution

The resolution of the measurement is determined by the selected range and accuracy as follows:

Low Accuracy selected: 5.5 digits.

High Accuracy selected: 6.5 digits.

Recall of Measured Value

The RDG? command (*page 5-46*) recalls the value of the measurement (the arithmetic mean of the most-recent sample of readings).

Range Change within DCI Function

The active Measurement Band and Guard selections are saved, then restored on reselection of the range.

Note: In remote operation, the saved band selection will be overwritten as it is mandatory to specify the required band when changing range. This 'save' facility is included only for local operation where it is more intuitive and efficient to select range and band separately.

Exit from DCI Function

The active Range, Band and Guard selections are saved on exit and re-activated on re-entry.

Reversion from Remote to Local

No Change.

Execution Errors

1026 Illegal band selection.

1027 Shunt serial number incorrect.

1028 10A selection requires shunt serial number.

Power On and Reset Conditions

DCI	Not active (DCV active)
Range	1A
Band	Zero
Guard	Local
Mode	High Accuracy

Trigger External

Input Zero: ZERO? Command (*page 5-44*)

When in any DCI range, in the zero band and with High Accuracy selected, the ZERO? command can be used to initiate an input zero measurement. The analog zero input must be applied externally.

The input zero measurement is carried out under the same conditions of resolution and sample size as the function/range in which it is commanded. The resulting error derives an offset correction.

The 4950 saves the correction in non-volatile RAM, then applies it in all subsequent measurements made on the same DCI range, until it is again measured on that range by another ZERO? command.

This facility can be used to nullify the effects of input source offsets up to the limits of the zero band (a total of $\pm 10\%$ of the nominal range value).

MEASUREMENT DEFINITION - MAJOR FUNCTIONS (Contd.)

AC Current

N.B. The number of readings to be taken in each ACI measurement sample, and hence the measurement resolution, depend on the selected 'Accuracy'. This must be set to 'High' or 'Low' as required *before* the Trigger command is sent. Refer to "Calculations and Facilities" on the opposite page.

The following commands are used to select ACI function along with its associated configuration.



Nrf is a decimal numeric value which is intended to represent the expected RMS value of the applied signal, so that the instrument will go to the most relevant range.

The Nrf spans for nominal range selection are as follows:

$0.00002 \leq Nrf \leq 0.000199$	100µA range
$0.0002 \leq Nrf \leq 0.001999$	1mA range
$0.002 \leq Nrf \leq 0.019999$	10mA range
$0.02 \leq Nrf \leq 0.199999$	100mA range
$0.2 \leq Nrf \leq 1.999999$	1A range
$2 \leq Nrf \leq 19.999999$	10A range

Note that the 10A range cannot be selected unless the shunt serial number has been entered. Refer to *Page 5-52*.

Measurement Band

As there is only one measurement band (100% — full range) there is no need for measurement band menus, and none are implemented. When ACI is selected, the 100% band limits are applied on all ranges and frequency bands.

Frequency Band Selection - **FREQ_fc**

FREQ_fc selects the frequency band, whose limits lie at $\pm 10\%$ of its center frequency, *fc*Hz. The characters to be used for *fc* are shown in the table.

Frequency Band Availability

The table shows the allocation of frequency bands to ranges. The starred boxes represent the only available range/frequency-band combinations:

Band Center Freq <i>fc</i> (Hz)	Range					
	100µA	1mA	10mA	100mA	1A	10A
10	*	*	*	*	*	*
20	*	*	*	*	*	*
30	*	*	*	*	*	*
40	*	*	*	*	*	*
55*	*	*	*	*	*	*
300*	*	*	*	*	*	*
1k	*	*	*	*	*	*
5k	*	*	*	*	*	*
10k	*	*	*	*	*	*
20k	*	*	*	*	*	*
30k	*	*	*	*	*	---

* The 55Hz and 300Hz Frequency bands are extended to include prominent line power frequencies of 50Hz, 60Hz and 400Hz. Refer to *Section 4, page 4-23*.

Frequency Band Limits - Error Messages

Higher Limit:

If the measured frequency of a signal exceeds the selected frequency band higher limit, then the message 'Error HF' appears on the main display of the front panel. A relevant query command (e.g. **FREQ?**) invokes the 'invalid number response', and the 'FHR' bit 2 is set in the Measurement Event Status Register.

Lower Limit:

If the frequency of a measured signal is less than the selected frequency band lower limit, then 'Error LF' appears on the main display of the front panel. A relevant query command (e.g. **FREQ?**) invokes the 'invalid number response', and the 'FLR' bit 1 is set in the Measurement Event Status Register.

Linked Error Reporting

The *frequency* is also reported as invalid if the signal *current* is outside the fixed band limits.

Partial Execution

For errors occurring in data elements within bypass routes (e.g. Guard controls) the command will be executed up to the start point of the bypass.

Optional Selection - Guard Connections**LCL_GUARD:** selects Local Guard.**REM_GUARD:** selects Remote Guard.**Calculations and Facilities**

When in ACI ranges, the following facilities are available:

ACCURACY: Refer to 'Measurement Samples' and 'Measurement Resolution' below; and to *Page 5-39*.

DEVTN?. *Page 5-48*

Measurement Samples

ACI measurements do not consist only of single readings. Each 'Measurement' derives from a single trigger, which generates a number of internal A-D conversions (sample) for the same input. The measurement result is the arithmetic mean of the sample. The sample size is determined by the Range and Accuracy selections as follows:

Accuracy	Range	Sample Size
High	All Ranges	8
Low	All Ranges	1

Time should be allowed for these readings to be taken, after sending the trigger to start the sample.

Measurement Resolution

The resolution of the measurement is determined by the selected range and accuracy as follows:

Range	Resolution (digits)	
	(Low Acc.)	(High Acc.)
All Ranges	5.5	6.5

Recall of Measured Value

The RDG? command (*page 5-46*) recalls the value of the measurement (the arithmetic mean of the most-recent block of readings).

Other Conditions**Range Change within ACI Function**

The active Band and Guard selections are saved and restored where appropriate.

Note: In remote operation, the saved band selection will be overwritten as it is mandatory to specify the required band when changing range. This 'save' facility is included only for local operation where it is more intuitive and efficient to select range and band separately.

Exit from ACI Function

The active Range, Band and Guard selections are saved on exit and restored on reselection of ACI function.

Reversion from Remote to Local

No Change.

Execution Errors

1026 Illegal band selection.

1027 Shunt serial number incorrect.

1028 10A selection requires shunt serial number.

Power On and Reset Conditions

ACI Function	Inactive
Range	1000
Frequency Band	1kHz
Guard	Local
Mode	High Accuracy
Trigger	External

4950 COMMANDS AND QUERIES - Syntax Diagrams (Contd.)

MEASUREMENT PARAMETERS AND RESULTS

Major Functions

Five major function commands select the type of measurement to be carried out, which configure the instrument to measure either DC Voltage, AC Voltage, DC Current, AC Current or Resistance. Each function command also programs appropriate parameters of range, measurement band, frequency band (AC), 2/4-wire connection (Ohms) and guard connection. Refer to *pages 5-28 to 5-37*.

Measurement Samples

Measurements do not consist only of single readings. A single trigger initiates a number (sample) of internal A-D conversions for the same input, and the 'Measurement' is the *Arithmetic Mean* of the whole sample. The number of conversions taken in each sample (Sample Size) is determined not only by the required *Function* and *Range*, but also by the *Accuracy Mode* selection. Refer to *Page 5-39*.

The quality of the measurement can also be obtained. Refer to *Page 5-48*.

Triggers

The trigger can be derived from internal or external sources, but external triggers are preferred, to prevent confusion due to asynchronous operation.

The source of trigger must obviously be set before the sample is triggered. Refer to *Page 5-42*.

SRQ Setup

Before the sample is triggered, any required SRQ response must also be programmed. This is done by setting the condition of three enabling registers in the status reporting system.

Refer to *Page 5-43*.

Access to Results

Once the results have been calculated and stored, they can be accessed by query commands: the Arithmetic Mean by RDG? and the Quality by DEVTN?. There is no data to read before the measurement has been triggered and completed, so these commands should not be sent until after the first trigger after power-on. (A result will always be given, but this will depend in part on the current state of the A-D cycle.).

Refer to *Pages 5-46 to 5-48*.

MEASUREMENT PARAMETERS

Accuracy Mode

The **ACCURACY** command is sent with one of two parameters to select the Accuracy Mode, which controls the number of readings in the sample and hence the accuracies of the measured mean and standard deviation. The Mode also

optimizes the reading resolution to fit the level of accuracy. The meanings of the parameters **LOW** and **HIGH** are self-evident. This command cannot be used when Calibration is enabled: all calibrations use High Accuracy Mode.

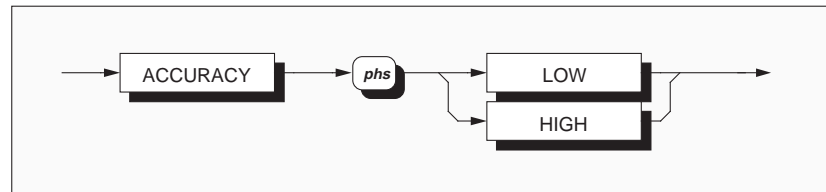

The table shows the specific effects on the instrument's functions and ranges.

Funct.	Range	Sample Size (internal readings)		Resolution (digits)	
		Low Acc.	High Acc.	Low Acc.	High Acc.
DCV	100mV	4	128	6.5	7.5
	1V-1000V	4	64	6.5	7.5
ACV	1mV	1*	8	4.5	5.5
	10mV-1000V	1*	8	5.5	6.5
Ohms	10Ω	4	128	6.5	7.5
	100Ω - 1MΩ	4	64	6.5	7.5
	10MΩ & 100MΩ	4	128	6.5	7.5
DCI	100μA-10A	1*	32	5.5	6.5
ACI	100μA-10A	1*	8	5.5	6.5

* for 'sample size' of 1 reading, the RDG? command presents the value of that reading as the mean value of the sample. The DEVTN? command results in the invalid response.

Execution Errors:

None.

Power On and Reset Conditions

The default condition is Low Accuracy.

Reversion from Remote to Local

No Change.

MEASUREMENT PARAMETERS

Correction Selector

'Certified' Corrections

The 4950 is designed to be used to calibrate the DCV, DCI, ACV, ACI and Resistance outputs of calibrators which are situated remotely from traceable standards. The 4950 is itself calibrated against traceable standards, updating corrections stored in the 4950's non-volatile calstores. These 'Certified' corrections carry the traceabilities of the standards during the transfer.

'Base' Corrections

A second set of corrections is also held in non-volatile memory. 'Base' corrections are those which were derived during original calibration at manufacture, and are never updated.

They are provided only as an invariant reference when verifying 'loop integrity'.

Loop Integrity

There are two basic scenarios for the use of the 4950 as a transfer standard:

a. 4950 Resident with Standards

The 4950 normally resides with the standards to which it is calibrated for the transfer. In order to verify loop integrity, the standards' outputs are measured twice: once before being shipped to the calibrator which it is to calibrate; and again after it returns from its transfer task.

If both of these sets of measurements verify within the 4950 specification; then loop integrity has been maintained, and valid figures are available to define the traceability of the calibrated calibrator.

In this scenario, the 4950 will be calibrated to the standards before shipment. So the 'Certified' corrections can be used for both measurements for the loop-integrity verification.

b. 4950 Resident with Calibrator

In this case, the 4950 normally resides with the calibrator which it is used to calibrate. In order to verify loop integrity, the *calibrator* outputs are measured twice: firstly before being shipped to the standard for its own calibration; and secondly after it returns but before it performs its transfer task.

As part of this transfer, the 'Certified' corrections are updated to the standards between the two loop-integrity measurements, so cannot be used for both measurements. This is why the 'Base' corrections have been provided. Because they do not change, they *can* be used for both measurements in the loop-integrity verification.

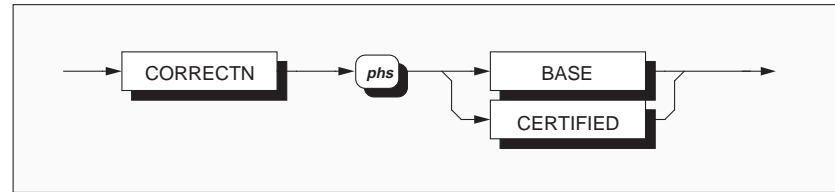
**CORRECTN BASE**

applies the **Base** corrections to all measurements, for use during loop integrity verification. Certified corrections are not applied.

CORRECTN CERTIFIED

applies the **Certified** corrections to all measurements. Base corrections are not applied.

Corrections in Calibration Mode

Entry to Calibration Mode enforces the application of **Certified** corrections to all measurements.

When operating in Calibration Mode, neither Base nor Cert corrections can be selected.

On exit from Calibration Mode, the certified corrections which were enforced on entry will not be cancelled on return to normal mode.

Execution Errors:

1034 Base selection invalid in Cal Mode.

1035 Cert selection invalid in Cal Mode.

Reversion from Remote to Local

No Change.

Power On and Reset Conditions

Certified corrections are applied.

MEASUREMENT PARAMETERS

Trigger Source Selector

Note: The use of internal triggers can produce unexpected results, due to the time required for the A-D conversion, and the A-D triggers being unsynchronized with the IEEE 488 bus operations. The sample trigger *can* be derived from internal or external sources, but external triggers are preferred, to prevent the confusion due to asynchronous operation.

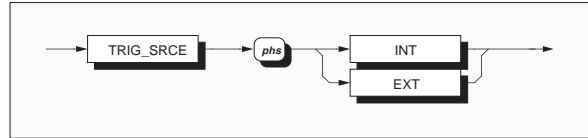

TRIG_SRCE INT

generates internal triggers within 0.5 second after completing the previous sample of measurements. External trigger sources are disabled.

TRIG_SRCE EXT

disables internal triggers and enables controller-generated external trigger sources. These are:

- IEEE 488.1: GET command.
- IEEE 488.2: *TRG command.

Execution Errors:

None.

Reversion from Remote to Local

No Change.

Power On and Reset Conditions

The default condition is TRIG_SRCE EXT.

Band Limits

Under normal circumstances, the 4950 is constrained to measure within narrow band limits of magnitude and frequency imposed on each 'nominal' measurement point. This command permits the 4950 to measure outside these limits without generating the normal error message.

Band Limits off should be used with extreme caution.

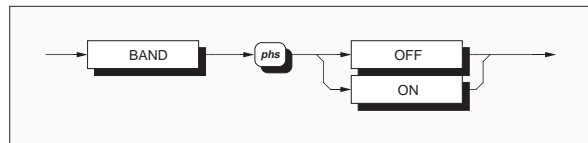

BAND OFF

measurements can be made outside band limits without generating the normal error message.

BAND ON

attempts to measure outside band limits will generate the normal error message.

Execution Errors:

None.

Reversion from Remote to Local

No Change.

Power On and Reset Conditions

The default condition is BAND ON.

MEASUREMENT DEFINITION - SRQ GENERATION

SRQ Origination

Certain listed events can be used to request attention from a controller. Part of programming a measurement is to decide which (if any) of these events will be enabled, and which will not. This must be done before triggers are sent, so the means of programming these decisions is mentioned here, although the subject is dealt with more thoroughly in other parts of this section.

The three commands which program the instrument's response to events are given below. A more detailed treatment is given elsewhere (*pages 5-16 to 5-27 and 5-59 to 5-68*).

Measurement Event Enable - MESE *Nrf* enables the **measurement** event bits which will generate a summary message in the standard defined service request byte. *Nrf* is a decimal number which, when converted into binary, programs the Measurement Event Status Enable register. Refer to *page 5-59*.

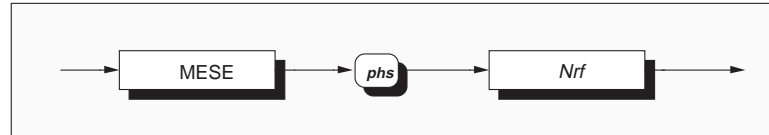

Event Status Enable - *ESE *Nrf* enables the **standard defined** event bits which will generate a summary message in the status byte. *Nrf* is a decimal number which, when converted into binary, programs the Standard-defined Event Status Enable register. Refer to *page 5-59*.

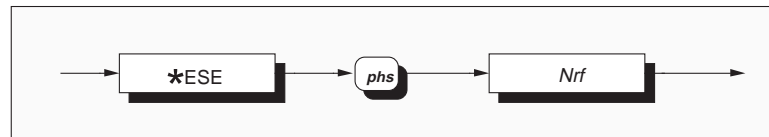

Service Request Enable - *SRE *Nrf* enables the **standard** and **measurement summary** bits in the service request byte, which will generate a service request. *Nrf* is a decimal number which, when converted into binary, programs the Service Request Enable register. Refer to *page 5-59*.

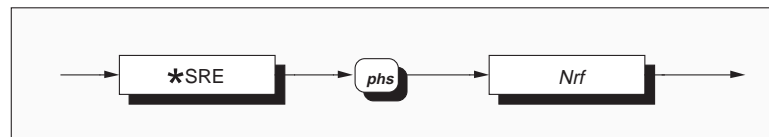

Trigger Reading

Execute Trigger

This command conforms to the IEEE 488.2 standard requirements.

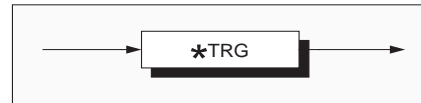

*TRG

is equivalent to a Group Execute Trigger (GET), and will cause a single reading to be taken when in external trigger mode.

Execution Errors:

1025 External trigger mode not selected.

Reversion from Remote to Local

Not applicable.

Power On and Reset Conditions

Not applicable.

Execute 'Input Zero'

Introduction

In the Zero band of any DCV, DCI or Ohms range, with High Accuracy selected, the ZERO? command can be used to initiate an input zero measurement. The analog zero input must be applied externally (see opposite page).

The measurement is carried out under the same conditions of resolution and sample size as the function/range in which it is commanded. The resulting error derives an offset correction.

The 4950 saves the correction in non-volatile RAM, then applies it in all subsequent measurements made on the same DCV, DCI or Ohms range (with either High and Low accuracy selected), until it is again measured on that function and range by another ZERO? command.

This facility can be used to nullify the effects of input source offsets up to the limits of the zero band (a total of $\pm 10\%$ of the nominal range value).

Availability

Input Zero is available only in **DCV, Ohms & DCI** functions; **not** in ACV or ACI.

Input Zero cannot be used in Calibration Mode.

Corrections are cleared on entry to Calibration mode.

Major Function Selection:

First select the required DCV, Ohms or DCI range, and the **zero** measurement band.

In Ohms ranges select **2-wire** or **4-wire** connection as required.

Input Connections:

The 5-way input connector remains plugged into the front panel.

The 4mm bananas at the remote end must be connected to each other *in the following order*:

DCV: Black into the rear of Red (Lo into Hi), all others disconnected.

Ohms: Brown into Blue into Black into Red (I+ into I- into Lo into Hi);
white remains disconnected.

DCI: All 4mm leads disconnected from one another.

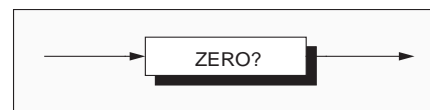
ZERO? Command

ZERO? Generates a trigger which initiates the input zero measurement.

Execution Errors:

1005 Input Zero not allowed

1023 Zero not allowed when cal enabled

Response Format and Decode:

The response is a single decimal digit (Nr1):

0 = Input Zero successful

1 = Input Zero unsuccessful

Reversion from Remote to Local

Not applicable.

Power On and Reset Conditions

Not applicable.

Reading Recall



RDG? recalls the most-recently completed measurement made by the instrument.

Response Format:

Character position

1	2	3	4	5	6	7	8	9	10	11	12	13	14
s	n	x	x	x	n	n	n	n	E	sg	p	p	nl

Where:

s = + or - or space
 n = 0 to 9
 x = either n or decimal point (.)
 E = ASCII character identifying the exponent
 sg = + or -
 p = 0 to 9 (exponent is in engineering units)
 nl = newline with EOI

Response Decode:

If no trigger has been received to generate a conversion of the input signal, then the response to this command will represent the most-recent measurement. If no measurement is available, the unavailable response is given. If a trigger has already been received, this query will wait for the completion of the measurement and place its result in the output queue.

Units of Returned Value:

DCV and ACV ranges: **Volts**
 DCI and ACI ranges: **Amps**
 Ohms ranges: **Ohms**

The value represents the arithmetic mean of the sample of applied signals. Any signal outside the programmed measurement band is represented by a value of +200E+33, and the relevant flag bit is set in the measurement event status byte.

Execution Errors:

None

Power On and Reset Conditions

All previous results are cleared at Power On and Reset, thus the unavailable response is given until after the first trigger.

Frequency Readings



FREQ? recalls the frequency associated with the most-recent measurement sample.

Response Format:

Character position

1	2	3	4	5	6	7	8	9	10	11	12	13	14
s	n	x	x	x	n	n	n	n	E	sg	p	p	nl

Where:

s = + or - or space
 n = 0 to 9
 x = either n or decimal point (.)
 E = ASCII character identifying the exponent
 sg = + or -
 p = 0 to 9 (exponent is in engineering units)
 nl = newline with EOI

Response Decode:

If no trigger has been received to generate a conversion of the input signal, then the response to this command will be the frequency of the most-recent measurement. If no measurement is available, the unavailable response is given. If a trigger has already been received, this query will wait for the completion of the measurement and place its result in the output queue.

A value of +200E+33 is returned if the query is invalid for the selected function, or if the measurement circuits cannot produce a result.

Returned Value

The returned value is expressed in **Hz**.

For any AC signal in ACV or ACI function, but outside the programmed frequency band, the measured value is still reported but the relevant flag bit is set in the measurement event status byte.

Execution Errors:

None

Power On and Reset Conditions

All previous results are cleared at Power On and Reset, thus the unavailable response is given until after the first trigger.

Return the Quality of Measurement

The measurement quality is the standard error of the mean of the internal sample.

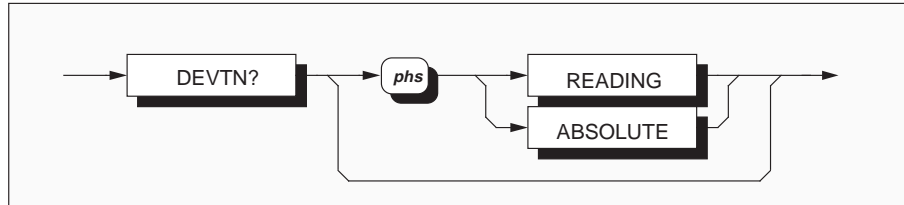

- DEVTN?** with no data element returns the quality in ppm of Nominal Full Range.
- DEVTN? pms READING** returns the quality in ppm of the measurement value.
- DEVTN? pms ABSOLUTE** returns the quality in values of the selected function.

Response Format:

Character position
 1 2 3 4 5 6 7 8 9 10 11 12 13 14
 s n x x x n n n n E sg p p nl

Where:

- s = + or - or space
- n = 0 to 9
- x = either n or decimal point (.)
- E = ASCII character identifying the exponent
- sg = + or -
- p = 0 to 9 (exponent is in engineering units)
- nl = newline with EOI

Availability of Results

The three versions of each successive quality calculation are stored in three locations, overwriting those from the previous sample, and remaining stored until overwritten by the results from the next sample. The contents of the appropriate store are read by the corresponding DEVTN? query.

Quality Measurement Invalid

The invalid response (200E+33) will be given, in place of the quality result, under the following conditions:

- **Any Function:**
 The *measured value* of the signal is not within the *measurement band* limits. The relevant bit will have been set in the Measurement Event Byte.
- **ACV or ACI only:**
 The measured *frequency* result is not within the *frequency band* limits. The relevant bit will have been set in the Measurement Event Byte.
- **ACV, DCI or ACI only:**
 The 4950 is in low accuracy mode with ACV, DCI or ACI function selected, (only one reading per sample). In these cases the quality value would be meaningless.

Quality (Contd.)**Reversion from Remote to Local:**

No change

Execution Errors:

None.

Power On and Reset Conditions:

All previous results are cleared at Power On and Reset, thus no quality result can exist until a new measurement has been executed. In these conditions the invalid response (200E+33) is returned to interrogation by this command.

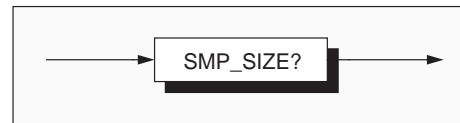
Recall the Sample Size

SMP_SIZE? returns the number of conversions in the most recent sample.

Response Format:

Character position

```
1 2 3
n n n
```

Where:

n = 0 to 9

and:

nnn represents the measurement sample size, as determined by function, range and accuracy mode selections.

Refer to the table of sample sizes on *page 5-39*.

Reversion from Remote to Local:

Not applicable.

Execution Errors:

None.

Power On and Reset Conditions:

Not applicable.

Instrument Stability Status



STANDBY? recalls the time remaining before the stabilized conditions for accurate operation are reached.

Response Syntax:

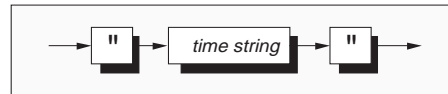

Response Format:

Character position
 1 2 3 4 5 6 7
 " h h : M M "

Where:

h h = two digits representing *hours*
 M M = two digits representing *minutes*

Execution Errors:

None

Power On and Reset Conditions

Not applicable.

Response Decode:

At initial Power On: the stabilization period is 6 hours so the reported time starts to count down from "05:59".

Subsequently, if power is turned off and on: a warm-up period is imposed, extending from a minimum of 10 minutes to a maximum of 6 hours. This is calculated automatically from the lengths of time the instrument has recently been turned off and on.

For details of the warm-up timing calculation, refer to *Page 3-5*.

INSTRUMENT CONFIGURATION

I/D (Instrument Identification)

This command conforms to the IEEE 488.2 standard requirements.

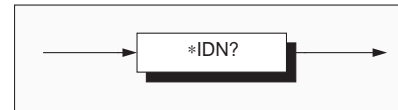

*IDN?

will recall the instrument's manufacturer, model number, serial number and firmware level.

Response Format:

Character position

1 2 3 4 5 6 7 8 9 10 11 12 13 14 15
D A T R O N W A V E T E K ,

16 17 18 19 20
4 9 5 0 ,

21 22 23 24 25 26 27 28 29 30 31 32 33
4 5 6 7 8 9 - X X . X X ,

34 35 36 37 38 39 40 41 42 43 44 45
8 9 0 1 9 7 - X X . X X

Where:

The data contained in the response consists of four comma-separated fields, the last two of which are instrument-dependent. The data element type is defined in the IEEE 488.2 standard specification.

Response Terminations

The normal rules for terminating responses apply (page 5-15).

Response Decode:

The data contained in the four fields is organized as follows:

- First field - manufacturer
- Second field - model
- Third field - serial number
- Fourth field - part number and issue revision number (will possibly vary from one instrument to another).

Execution Errors:

None.

Power On and Reset Conditions

Not applicable.

Set 10A Shunt Serial Number

This command allows a user to enter a string of up to 12 characters which form the serial number of the shunt to be used with the 10A range.

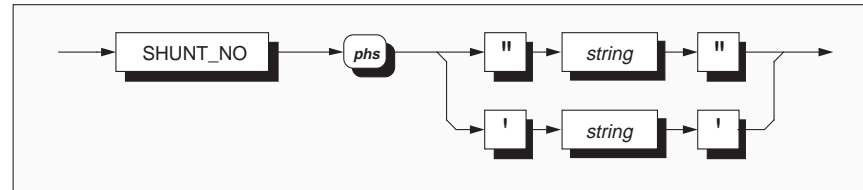

SHUNT_NO allows access to enter the shunt serial number.

string ASCII printing characters.

The shunt serial number is set in quotes so that a free format can be used for the number itself.

It can be recalled using the query 'SHUNT_NO?'. Refer to *page 5-53*.

Normal Operating Mode

When used in normal operating mode the entered string is required to match the string which was stored, during calibration, into non-volatile RAM. If they do match, the instrument can be used in the 10A range.

Execution Error

If there is no match, there is no access to the 10A range and the controller is alerted by an execution error:

1027 Shunt serial number incorrect.

Calibration Mode

When used in calibration mode this command will store the string in non-volatile RAM for subsequent comparisons. Note that there are additional correction factors stored during calibration of the 10A range which will be used for measurement correction on that range.

Execution Error

In order to enter calibration mode the ENBCAL command is sent, together with the rear-panel CALIBRATION switch set to the ENABLE position.

If, meanwhile, the calibration switch has been turned to DISABLE, the shunt serial number store cannot be written to and the controller is alerted by an execution error:

1002 Calibration disabled.

Power On and Reset Conditions

The shunt serial number is saved in non-volatile memory, so is not destroyed at Power Off.

After Power On the shunt serial number must be entered to gain access to the 10A range. Only one matched entry is necessary between power on and off (i.e. Reset does not clear the matched indicator).

Query Shunt Serial Number



SHUNT_NO? recalls the serial number of the 10A shunt which was used during the most-recent certified calibration of the 10A range.

Response Syntax:

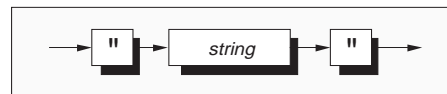

Response Decode:

Up to 12 characters can be present, forming the serial number of the shunt, which was stored using the SHUNT_NO command.

Execution Errors:

None

Power On and Reset Conditions

Not applicable.

Set 2-Wire Ohms lead Serial Number

This command allows a user to enter a string of up to 12 characters which form the serial number of the lead to be used for 2-wire Ohms measurement.

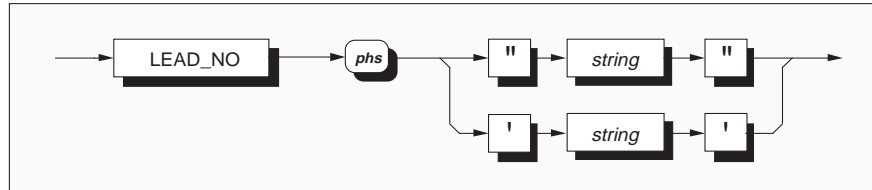

LEAD_NO allows access to enter the lead serial number.

string up to 12 ASCII printing characters.

The serial number is set in quotes so that a free format can be used for the number itself.

It can be recalled using the query 'LEAD_NO?'. Refer to *page 5-55*.

Normal Operating Mode

When used in normal operating mode the entered string is required to match the string which was stored, during calibration, into non-volatile RAM. If they do match, 2-wire Ohms measurements can be made.

Execution Error

If there is no match, there is no access to 2-wire Ohms measurement and the controller is alerted by an execution error:

1033 Lead serial number incorrect.

Calibration Mode

When used in calibration mode this command will store the string in non-volatile RAM for subsequent comparisons. Note that there are additional correction factors stored during 2-wire Ohms calibration which will be used for measurement correction.

Execution Error

In order to enter calibration mode the ENBCAL command is sent, together with the rear-panel CALIBRATION switch set to the ENABLE position.

If, meanwhile, the calibration switch has been turned to DISABLE, the lead serial number store cannot be written to and the controller is alerted by an execution error:

1002 Calibration disabled.

Power On and Reset Conditions

The lead serial number is saved in non-volatile memory, so is not destroyed at Power Off.

After Power On the lead serial number must be entered to access 2-wire ohms measurements. Only one matched entry is necessary between power on and off (i.e. Reset does not clear the matched indicator).

Query Lead Serial Number



LEAD_NO? recalls the serial number and resistance value of the lead which was used during the most-recent certified calibration of 2-wire Ohms.

Response Syntax:

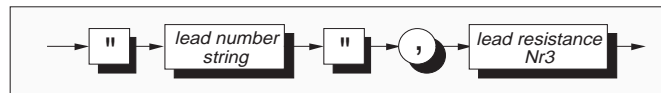

Response Decode:

Up to 12 characters form the serial number of the lead. A comma separates the lead number string from a decimal 'Nr3' floating point number in engineering notation which represents the lead resistance in ohms. The whole response typically takes the form:

"34526",0.0013E+0

The lead number is entered using the LEAD_NO command during calibration (*page 5-54*).

The value of lead resistance is characterized using the CHSE? LEAD query command during normal (certified) calibration (*page 5-95*).

Execution Errors:

None

Power On and Reset Conditions

Not applicable.

Recall the Selected Ambient Temperature of Certified Calibration



CERT_AMB? recalls the selected ambient temperature at which the certified calibration was carried out. The response is in Nr1 format, and will only be either 20°C or 23°C.

Reversion from Remote to Local:
Not applicable.

Power On and Reset Conditions:
Not applicable.

Execution Errors:
None.

Recall the Present Temperature / Temperature Difference

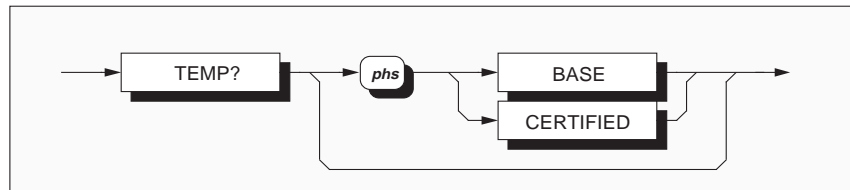

TEMP?
Returns the internal temperature of the instrument.

Response Format and Decode:
'Nr3' decimal.
The response is a value in degrees Celsius.

TEMP? BASE
Returns the difference between the present internal temperature and that at baseline calibration.

Reversion from Remote to Local:
Not applicable.

TEMP? CERTIFIED
Returns the difference between the present internal temperature and that at certified calibration.

Execution Errors:
None.

Power On and Reset Conditions:
Not applicable.

Recall the Present / Certified / Baseline Date

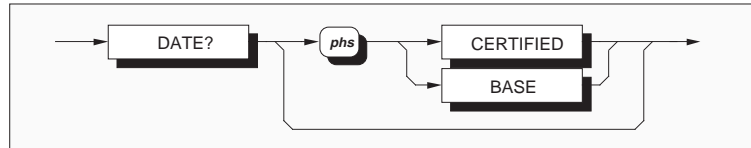

DATE?

Returns today's date.

DATE? CERTIFIED

Returns the date of the most recent certified calibration.

DATE? BASE

Returns the date of the most recent baseline calibration.

Response Syntax:

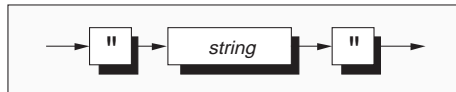

Response Format:

Character position in string

1	2	3	4	5	6	7	8	9	10	11
y	y	y	y	-	m	m	m	-	d	d

e.g. 1 9 9 1 - S E P - 1 4

Where:

yyyy = four numeric characters: *year*

mmm = three alpha characters: *month*

dd = two numeric characters: *day of month*

Execution Errors:

None

Power On and Reset Conditions

Not applicable.

Recall the 4950 Instrument Hardware Fitment

This command conforms to the IEEE 488.2 standard requirements.

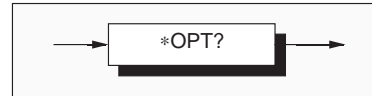

*OPT?

will recall the instrument's hardware fitment.

Response Format:

Character position

1 2 3 4 5 6
x1 , x2 , x3 nl

Where:

The data in the response consists of comma-separated characters, each being either 1 or 0.

nl = newline with EOI

The data element type is Nr1 as defined in the IEEE 488.2 standard specification.

Response Decode:

The character positions represent the following hardware fitment:

- x1 - AC Assembly
- x2 - Ohms Assembly
- x3 - Current Assembly

x1 = 1 indicates that the assembly is fitted,
x1 = 0 indicates that the assembly is not fitted.

Execution Errors:

None.

Power On and Reset Conditions

Not applicable.

Status Reporting

Most of the commands in this sub-section are standard reporting commands defined in the IEEE-488.2 standard. For greater detail, refer to *pages 5-16 to 5-27*.

Status Reporting Structure

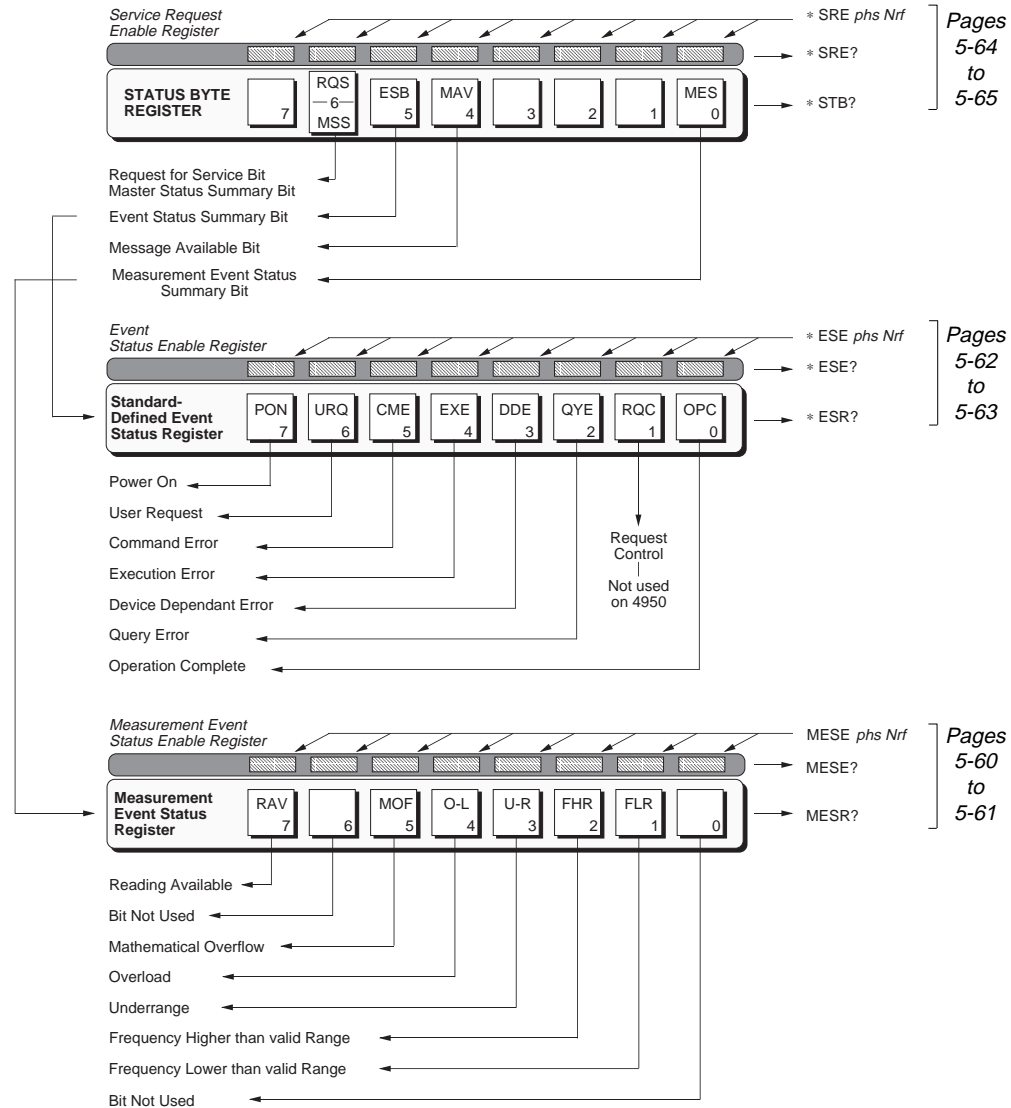

Measurement Event Enable

This measurement event status data structure conforms to the IEEE 488.2 standard requirements for this structure.

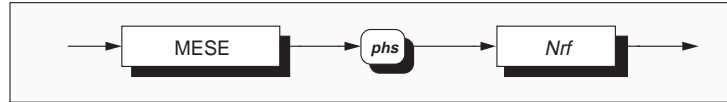

MESE

enables the measurement event bits which will generate a summary message in the standard defined service request byte. Refer to *page 5-59*.

Note that numbers **will** be rounded to an integer.

Nrf is a Decimal Numeric Data Element representing a value which, when rounded to an integer and expressed in base 2 (binary), enables the appropriate bits in this event enable register.

Execution Errors:

None.

For example:

32 will enable the MOF bit;

24 will enable Overload and Underrange.

Power On and Reset Conditions

Not applicable.

Recall Measurement Event Enable

This measurement event status data structure conforms to the IEEE 488.2 standard requirements for this structure.

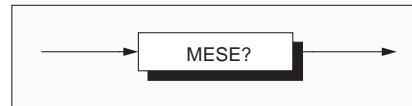

MESE?

recalls the measurement status register enable mask. Refer to *page 5-59*.

Response Decode:

The value returned, when converted to base 2 (binary), identifies the enabled bits which will generate a summary message in the service request byte, for this data structure. See the device status reporting model for detail.

Response Format:

Character position
 1 2 3 4
 n n n nl

Execution Errors:

None

Where:

n = 0 to 9
 nl = newline with EOI

Power On and Reset Conditions

Cleared (ie. nothing enabled).

Read Measurement Event Register

This measurement event status data structure conforms to the IEEE 488.2 standard requirements for this structure.

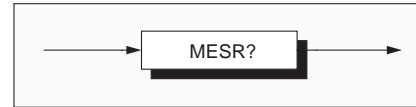
**MESR?**

reads the event register for measurement qualifiers destructively. Refer to *page 5-59*. The register is also cleared by the common command *CLS.

Response Format:

Character position			
1	2	3	4
n	n	n	nl

Where:

n = 0 to 9
nl = newline with EOI

Response Decode:

The value returned, when converted to base 2 (binary), identifies the events that have occurred since the most-recent read or general clear of this register. The detail is contained in the status data structure description.

Execution Errors:

None.

Power On and Reset Conditions

The register is cleared.

Event Status Enable

This event status data structure conforms to the IEEE 488.2 standard requirements for this structure.

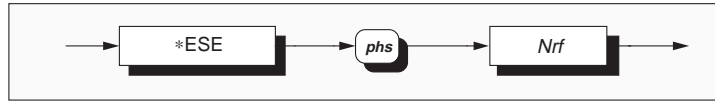

***ESE** enables the standard defined event bits which will generate a summary message in the status byte. Refer to *page 5-59*.

Nrf is a Decimal Numeric Data Element representing an integer decimal value equivalent to the Hex value required to enable the appropriate bits in this 8-bit register. The detail definition is contained in the IEEE 488.2 standard document. Note that numbers **will** be rounded to an integer.

Execution Errors:
None.

Reset Conditions
No change.

Power On Conditions
The Event Enable register is saved in non-volatile RAM. At Power On if the condition stored by the common *PSC command is 1, then the register is cleared. Otherwise it retains the saved value.

Recall Event Status Enable

This event status data structure conforms to the IEEE 488.2 standard requirements for this structure.

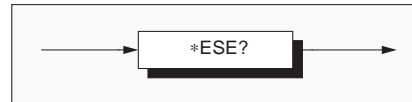

***ESE?** recalls the enable mask for the standard defined events. Refer to *page 5-59*.

Response Format:
Character position
1 2 3 4
n n n nl

Where:
n = 0 to 9
nl = newline with EOI

Response Decode:
The value returned, when converted to base 2 (binary), identifies the enabled bits which will generate a summary message in the service request byte, for this data structure. The detail definition is contained in the IEEE 488.2 document.

Execution Errors:
None

Power On and Reset Conditions
Not applicable.

Read Event Status Register

This event status data structure conforms to the IEEE 488.2 standard requirements for this structure.

***ESR?**

recalls the standard defined events.
Refer to *page 5-59*.

Response Format:

Character position
1 2 3 4
n n n nl

Where:

n = 0 to 9
nl = newline with EOI

Response Decode:

The value returned, when converted to base 2 (binary), identifies the bits as defined in the IEEE 488.2 standard.

Execution Errors:

None

Reset Conditions

No change.

Power On and Reset Conditions

The power-on bit (PON - bit 7) is set, all others are cleared.

Service Request Enable

This measurement event status data structure conforms to the IEEE 488.2 standard requirements for this structure.

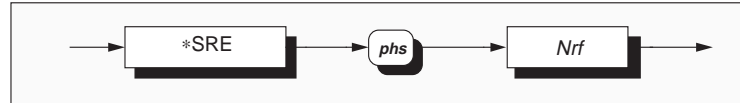

***SRE** enables the standard and user-defined summary bits in the service request byte, which will generate a service request. Refer to *page 5-59*.

Nrf is a Decimal Numeric Data Element representing an integer decimal value equivalent to the Hex value required to enable the appropriate bits in this 8-bit register. The detail definition is contained in the IEEE 488.2 document. Note that numbers **will** be rounded to an integer.

Execution Errors:

None.

Reset Conditions

No change.

Power On Conditions

The Service Request Enable register is saved in non-volatile RAM. At Power On if the condition stored by the common *PSC command is 1, then the register is cleared. Otherwise it retains the saved value.

Recall Service Request Enable

This measurement event status data structure conforms to the IEEE 488.2 standard requirements for this structure.

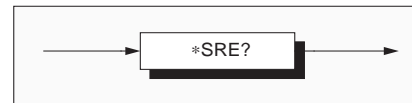

*SRE?

recalls the enable mask for the standard defined events. Refer to *page 5-59*.

Response Format:

Character position
 1 2 3 4
 n n n nl

Where:

n = 0 to 9
 nl = newline with EOI

Response Decode:

The value returned, when converted to base 2 (binary), identifies the enabled bits which will generate a service request. The detail is contained in the IEEE 488.2 standard document.

Execution Errors:

None.

Power On and Reset Conditions

Not applicable.

Read Service Request Register

This measurement event status data structure conforms to the IEEE 488.2 standard requirements for this structure.

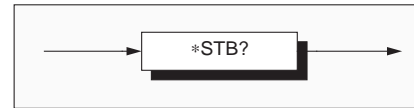
***STB?**

recalls the service request register for summary bits. Refer to *page 5-59*.

Response Format:

Character position

1	2	3	4
n	n	n	nl

Where:

n = 0 to 9
nl = newline with EOI

Response Decode:

The value returned, when converted to base 2 (binary), identifies the summary bits for the current status of the data structures involved. For the detail definition see the IEEE 488.2 standard document. There is no method of clearing this byte directly. Its condition relies on the clearing of the overlying status data structure.

Execution Errors:

None.

Reset Conditions

No change.

Power On Condition

Depends on:

- Event Enable Register
- Status Enable Register
- Power On Status.

Power On Status Clear

This common command conforms to the IEEE 488.2 standard requirements.

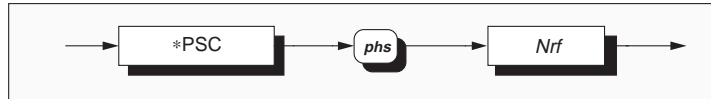

*PSC

sets the flag controlling the clearing of defined registers at Power On.

Nrf is a decimal numeric value which, when rounded to an integer value of zero, sets the *power on clear flag false*. This allows the instrument to assert SRQ at power on.

When the value rounds to an integer value other than zero it sets the *power on clear flag true*, which clears the standard *event status enable* and *service request enable* registers so that the instrument will not assert an SRQ on power up.

Examples:

*PSC 0 or *PSC 0.173 sets the instrument to **assert** an SRQ at Power On.

*PSC 1 or *PSC 0.773 sets the instrument to **not assert** an SRQ on Power On.

Execution Errors:

None.

Power On and Reset Conditions

The state of *PSC is saved in non-volatile RAM.

Recall Power On Status Clear Flag

This common command conforms to the IEEE 488.2 standard requirements. The flag condition is determined by the *PSC command (opposite page).

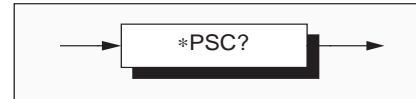
***PSC?**

will recall the Power On Status condition.

Execution Errors:

None

Response Format:

A single ASCII character is returned.

Power On and Reset Conditions:

No Change. This data is saved in non-volatile memory at Power Off, for use at Power On.

Response Terminations:

The normal rules for terminating responses apply (*page 5-15*).

Response Decode:

The value returned identifies the state of the saved flag:

Zero indicates **false**. The instrument **is not** programmed to clear the Standard Event Status Enable Register and Service Request Enable Register at Power On, so the instrument will generate a 'Power On' SRQ.

One indicates **true**. The instrument **is** programmed to clear the Standard Event Status Enable Register and Service Request Enable Register at Power On, so the instrument cannot generate a 'Power On' SRQ.

Clear Status

This measurement event status data structure conforms to the IEEE 488.2 standard requirements for this structure.

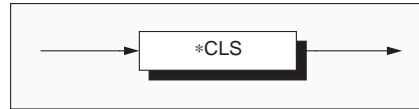

***CLS**

clears all the event registers and queues except the output queue. The output queue and MAV bit will be cleared if *CLS immediately follows a 'Program Message Terminator'; refer to the IEEE 488.2 standard document.

Execution Errors:

None.

Power On and Reset Conditions

Not applicable.

Error Reporting - Device-Dependent, Execution and Command Errors

Error Detection

If an error cannot be recovered transparently, it will result in some system action to inform the user via a message, and where possible restore the system to an operational condition.

Errors are dealt with according to their nature:

Recoverable errors report the error and continue.

System errors which cannot be recovered cause the system to halt with a message displayed. In this case, restarting the system from power on may clear the error, but generally such messages are caused by hardware or software faults.

Reporting Method

In both Remote and Local operation, Device-dependent, Execution and Command Errors are reported by the mechanisms described in the subsection which deals with status reporting, and the queue entries can be read destructively as LIFO by the queries DDQ?, EXQ? or CMQ? respectively.

A Remote user *can* ignore the queue, but it is good practice to read the errors as they occur.

The queue cannot be read in local operation, but the local user can continue by pressing any primary menu key. The error is, however, added to the queue so that it can be retrieved in remote operation. When entering remote operation *normally* (when it is not intended to investigate errors generated in local) it is advisable to empty old errors from the queue using the common command *CLS.

Code numbers for device dependent, execution and command errors, with their associated descriptions, are given in Appendix A to Section 4 (command error codes are available only to remote users).

Device-Dependent Errors (DDE)

A Device-Dependent Error is generated if the device detects an internal operating fault (eg. during self-test). The DDE bit (bit 3) is set *true* in the Standard-defined Event Status Byte, and the error code number is appended to the Device-Dependent Error queue.

Most Device-Dependent code numbers refer to a particular stage in the selftest, indicating failure of an individual test.

Execution Errors (EXE)

An Execution Error is generated when a valid command has been correctly parsed, but cannot be actioned due to the instrument state (e.g. attempting to change Accuracy mode by ACCURACY *phs* LOW when calibration is enabled), or when data is out of prescribed value limits. The EXE bit (bit 4) is set *true* in the Standard-defined Event Status Byte, and the error code number is appended to the Execution Error queue.

Command Errors (CME)

A Command Error is generated when a command does not satisfy the device command syntax and hence the IEEE 488.2 generic syntax (programmed into the instrument's parser), and so is not recognized as a valid command. The CME bit (bit 5) is set *true* in the Standard-defined Event Status Byte, and the error code number is appended to the Command Error queue.

Error Reporting (Contd.)

Recall Device Errors

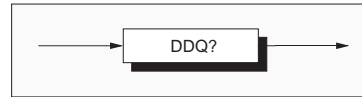

DDQ?

recalls the last error from the queue of device dependent errors (e.g errors recorded during a failed selftest).

The queue is organized as a last-in - first-out stack, its individual entries being destructively read. If there are no entries in the queue, then use of this command generates a result of zero, followed by an 'empty' message.

Read the Queue until Empty

It is good practice to read the queue until empty on each occurrence of device-dependent error, to prevent unrelated history of errors being retained.

Response Format:

```
Character position
1 2 3 4 5 6 .....41
n n n n , " String "
```

Where:

n = 0 to 9
String = A 34-character string which describes the error

Response Decode:

The value returned is a specified integer value indicating the fault. Refer to 'Error Reporting' on page 5-69, and for the meanings of specific codes to Appendix A of Section 4.

Execution Errors:

None.

Reversion from Remote to Local

Not applicable.

Power On and Reset Conditions

Not applicable.

Recall Execution Errors



EXQ?

recalls the last error from the queue of execution errors. An execution error occurs when a valid command has been correctly parsed, but cannot be complied with (e.g attempting to change Accuracy mode by ACCURACY *phs* LOW when calibration is enabled).

Response Format:

Character position
 1 2 3 4 5 6 41
 n n n n , " *String* "

Where:

n = 0 to 9
String = A 34-character string which describes the error

Response Terminations

The normal rules for terminating responses apply (page 5-15).

Response Decode:

The value returned is a specified integer value indicating the fault. For details of the number/fault relationship refer to Appendix A to Section 4 of this handbook. Execution Errors are reported in the form required by the IEEE 488.2 standard document.

The execution error queue operates as a last in - first out stack, and individual entries are read destructively. If there are no entries in the queue, then use of this command produces a result of zero, followed by an 'empty' message.

Read the Queue until Empty

It is good practice to read the queue until empty on each occurrence of execution error, to prevent retention of an unrelated history of errors.

Execution Errors:

None

Power On and Reset Conditions

Not applicable.

Error Reporting (Contd.)

Recall Command Errors

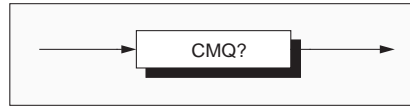

CMQ?

recalls the last error from the queue of command errors. A command error occurs when a command cannot be correctly parsed.

Response Format:

Character position
 1 2 3 4 5 6 41
 n n n n , " *String* "

Where:

n = 0 to 9
String = A 34-character string which describes the error

Response Terminations

The normal rules for terminating responses apply (page 5-15).

Response Decode:

The value returned is a specified integer value indicating the fault. For details of the number/fault relationship refer to Appendix A to Section 4 of this handbook. Command Errors are reported in the form required by the IEEE 488.2 standard document.

The command error queue operates as a last in - first out stack, and individual entries are read destructively. If there are no entries in the queue, then use of this command produces a result of zero, followed by an 'empty' message.

Read the Queue until Empty

It is good practice to read the queue until empty on each occurrence of command error, to prevent retention of an unrelated history of errors.

Execution Errors:

None

Power On and Reset Conditions

Not applicable.

Test Operations

Selftest

This command conforms to the IEEE 488.2 standard requirements.

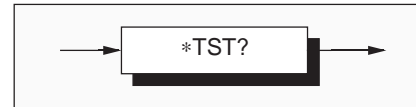

*TST?

executes the selftest. A response is generated after the test is completed (or halted following detection of a failure). The selftest cannot be performed when in Calibration mode.

Response Format:

Character position
1 2
n nl

Where:

n = 0 or 1
nl = newline with EOI

Response Decode:

The value returned identifies pass or failure of the selftest:

ZERO indicates selftest complete with no errors detected.

ONE indicates selftest has failed and halted. The errors can be found in the device dependent error queue. Refer to RTST?, on page 5-74.

Execution Error:

1021 Test not allowed when cal enabled.

Recall Device Errors

DDQ? recalls the last error from the queue of device-dependent errors (e.g errors recorded during an unsuccessful selftest). Refer to page 5-70.

N.B.

When the test of any of the following parameters is unsuccessful, the relevant device-dependent error message may be accompanied by a further qualification:

- a. Main Reference drift,
- b. A-D Positive ± 16 reference drift,
- c. A-D Negative ± 16 reference drift, or
- d. Reference Ratio drift

The qualifying message will result from a check of the 4950 status to determine whether any of the following conditions apply:

- Is the instrument still within its 6 hour warm up period?
- Is the internal temperature outside $\pm 3^\circ\text{C}$ of that at certified calibration?
- Has 30 days expired since the most-recent certified calibration?

If any of these conditions apply, then an appropriate comment is returned, together with the relevant device-dependent error number.

Refer to Section 4, Appendix A.

Reversion from Remote to Local

Not applicable.

Power On and Reset Conditions

Not applicable.

Resume Selftest



RTST?

resumes a selftest which was interrupted to report a test failure. When the selftest is eventually completed (or halted following detection of another failure), a response is given.

Response Format:

Character position
1 2
n nl

Where:

n = 0 or 1
nl = newline with EOI

Response Decode:

The value returned identifies pass or failure of the selftest which was resumed:

ZERO indicates test complete with no errors detected.

ONE indicates the resumed selftest has failed and halted. The errors can be found in the device dependent error queue.

Execution Errors:

None.

Reversion from Remote to Local

Not applicable.

Power On and Reset Conditions

Not applicable.

Recall Device Errors

DDQ recalls the last error from the queue of device-dependent errors (e.g errors recorded during a failed selftest). Refer to *page 5-70*.

Internal Operations Commands

All of the commands under this heading are common commands defined in the IEEE-488.2 standard.

Reset

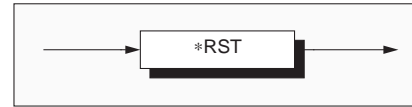

***RST**

will reset the instrument to a defined condition, stated for each applicable command with the command's description, and listed in Appendix B to this section.

The reset condition is independent of past-use history of the instrument except as noted below:

*RST does not affect the following:

- the selected address of the instrument;
- calibration data that affect specifications;
- SRQ mask conditions;
- the state of the IEEE 488.1 interface;

The action of the front panel **Reset** key is **not** equivalent to *RST, but is a subset of it.

Execution Errors:

None.

Power On and Reset Conditions

Not applicable.

Internal Operations Commands (Contd.)

Operation Complete

This command conforms to the IEEE 488.2 standard requirements.

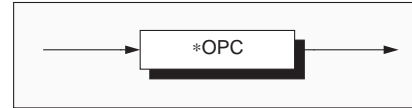

*OPC

is a synchronization command which will generate an operation complete message in the standard Event Status Register when all pending operations are complete.

Execution Errors:

None.

Power On and Reset Conditions

Not applicable.

Operation Complete?

This command conforms to the IEEE 488.2 standard requirements.

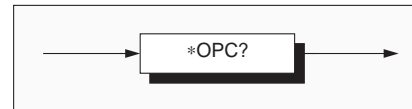

Response Format:

Character position
1 2
n nl

Response Decode:

The value returned is always 1, which is placed in the output queue when all pending operations are complete.

Where:

n = 1
nl = newline with EOI

Wait

This command conforms to the IEEE 488.2 standard requirements.

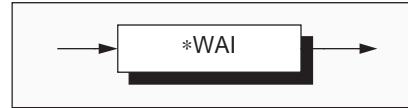
***WAI**

prevents the instrument from executing any further commands or queries until the *No Pending Operations Flag* is set true. This is a mandatory command for IEEE-488.2 but has no relevance to this instrument as there are no parallel processes requiring Pending Operation Flags.

Execution Errors:

None.

Power On and Reset Conditions

Not applicable.

General Queries

Recall of User Data

This common command conforms to the IEEE 488.2 standard requirements.

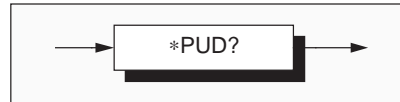

***PUD?** recalls user data, previously entered in Calibration mode.
Refer to program command ***PUD**, page 5-95.

Response Syntax:

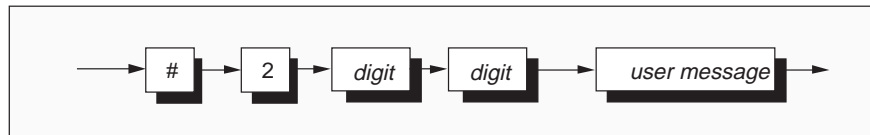

where:

digit = one of the ASCII-coded numerals previously entered,
user message = the saved user message.

Response Decode:

The previously-saved message is recalled.

Execution Errors:

None.

Response Terminations

The normal rules for terminating responses apply
(page 5-15).

Power On and Reset Conditions

Data area remains unchanged.

Recall the Present Time**TIME?**

will return the time that the query was processed.

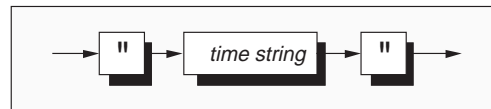
Response Syntax:**Response Format:**

Character position	1	2	3	4	5	6	7
	"	h	h	:	M	M	"

Where:

h h = two digits representing *hour*
 M M = two digits representing *minute*

Response Terminations

The normal rules for terminating responses apply (*page 5-15*).

Response Sources and Decode

The returned time is derived from the time most-recently entered when in calibration mode: either from the front panel, or as a parameter of the DATE command (*page 5-94*). This command sets the internal clock which has run on to give today's date and time.

Execution Errors:

None

Power On and Reset Conditions

Not applicable. Present time is calculated from data saved in non-volatile memory.

Calibration Commands and Messages

Important

The descriptions in the following pages are intended only as a guide to the messages available to calibrate the instrument. They contain neither examples nor calibration routines, and should NOT be used directly as a basis for calibrating any part of the instrument. Some of the commands, if used unwisely, will obliterate an expensive calibration or recalibration.

For a guide to calibration routines refer to *Section 8*.

Use of Control Software

It is likely that the majority of users will employ the suite of control software supplied with the 4950. This allows an operator to drive the various specialized comparison and calibration tasks of the system without the need to program individual commands and queries. Refer to *Section 1 Pages 1-6/7*.

Operating instructions for the Control Software are given in documentation which accompanies the software package. The following information is provided for users whose requirements are not met by the suite of programs, and who need to program their own application software. Refer to the Caution at the top of this page.

Calibration Sequences

Remote calibration via the IEEE 488 system bus generally follows similar sequences (and is subject to similar constraints) as for local calibration. But because the remote method does not require a human operator to access real-time sequences of commands via a single menu screen, it is possible to group commands together within bus message units.

For this reason we should not always expect to find a one-to-one correspondence between the local and remote calibration commands.

General Outline of Calibration Operations

The calibration process generally conforms to a set sequence of operations:

1. The rear-panel switch must be set to ENABLE, then calibration is enabled using the ENBCAL command, which also requires either 'baseline' or 'certified' calibration to be selected. For baseline calibration, a pass number must be included in the command string. The pass number is memorized in firmware, and is thus not alterable by the user. If the pass number does not match, or the rear-panel switch is not set to ENABLE, then access is denied to the calibration stores.

Successful entry to certified calibration mode is shown by the legend 'cal' appearing on the main front-panel display. Entry to baseline calibration will be indicated by two legends on the main display: 'cal' and 'spl'.

2. With the required function, range and band selected, and the appropriate analog input applied, the calibration operation is triggered (usually using the CAL? query). An optional parameter is available for use with CAL? when the calibration is to be performed at a non-nominal value (this parameter can also be set using the 'NOMINAL' command before sending CAL?).

Subsequently, in normal use; gain and flatness calibrations are applied to correct the pre-selected function, range and band.

3. Other operations can be carried out, such as frequency calibration, setting the calendar/clock or recording the ambient temperature at calibration.
4. When all calibration operations are complete, the EXIT DATE command can be used to record the date of the current calibration and then disable Calibration Mode. Further security is obtained by switching the rear panel switch to DISABLE.

Successive calibration program message units can be sent within a single program message; but as it is normal for calibration operations to be interspersed with other actions to change ranges, inputs etc., it is more usual for each calibration operation to use a terminated program message.

Enable Calibration

The ENBCAL command allows access to 'certified' or 'baseline' calibration operations, provided the calibration switch on the rear panel is set to 'ENABLE'.

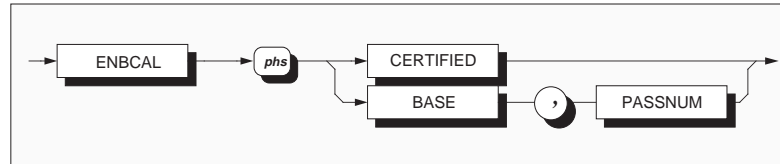

Effects of Data Elements

CERTIFIED

If the rear-panel switch is not set to ENABLE, then access is denied to the 'Certified' calibration stores.

Successful entry to Certified calibration mode will be indicated by the legend 'cal' on the main front-panel display. When entering Certified calibration mode, the first automatic action by the 4950 is to clear any offset in the Input Zero stores.

A subsequent CAL? will trigger Certified calibration of the gain of the selected function/range/band/(frequency band).

When already in Certified calibration mode, it is *not* possible to select Baseline calibration mode without using the EXIT command; but if necessary, it *is* possible to reselect Certified mode by sending ENBCAL CERTIFIED. This clears the Input Zero stores again.

BASE

N.B. Baseline calibration is a specialized process, carried out at manufacture and when major components are changed. Because some commands can apply both to baseline *and* to certified calibrations, there are overlaps. For completeness, these commands are shown with all available data elements.

If the rear-panel switch is not set to ENABLE, then access is denied to the 'Baseline' calibration stores.

Before access to Baseline Calibration is permitted, it is necessary to include a pass number in the string as shown in the syntax diagram. The correct pass number is registered in firmware, and cannot be altered by the user. If the entered pass number does not match, then access is denied to the baseline calibration stores.

Baseline calibration is not intended to be available to users, is not described further in this handbook, and should not be attempted.

Other Conditions**Protected Commands**

Provided the rear panel switch is in the enable position, ENBCAL with either parameter enables the following protected commands:

CAL?
 CAL_FREQ?
 SHUNT_NO
 LEAD_NO
 NOMINAL
 NOM_FREQ
 CERT_LOAD
 EXIT

ENBCAL with 'CERTIFIED' parameter enables the additional protected commands:

*PUD
 DATE
 CERT_AMB
 CHSE? LEAD

ENBCAL with 'BASE' parameter enables the additional protected commands:

SERIAL
 BASE_LOAD
 CHSE? ACLIN
 CHSE? Tmpr
 CLR?

Disabled Commands

When calibration is enabled with either parameter, the following commands are disabled:

ZERO?
 ACCURACY
 CORRECTN
 *TST?
 RTST?

It is not possible to select Baseline calibration from within Certified calibration mode; and vice versa.

Execution Errors:

1002 Calibration disabled
 1005 Input zero not allowed
 1006 Cal mode change must be via exit
 1007 Invalid numeric data
 1009 Passnumber entry error
 1013 Data out of limit
 1016 Not in special calibration
 1019 Temperature cal needs BASE cal enabled
 1020 Lead cal needs CERT cal enabled
 1021 Test not allowed when cal enabled
 1023 Zero not allowed when cal enabled
 1024 Invalid date format entered
 1029 BASELINE calibration not enabled
 1031 2 wire required for lead calibration
 1034 Base selection invalid in cal mode
 1035 Cert selection invalid in cal mode

Power On and Reset Conditions

Calibration disabled.

Trigger 'Calibration'

The CAL? command triggers a calibration event. Optional selection of a user-specific non-nominal target value is also available. This value can be recalled using the 'NOMINAL?' query (Page 5-86).

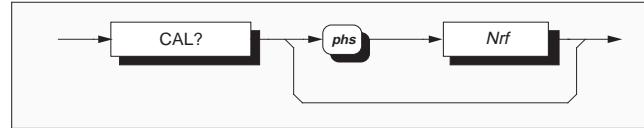

Calibration Point Targeting

Selecting a combination of Function, Range, Magnitude band (and Frequency band if ACV or ACI) forces a default 'nominal' calibration target value (as described by the command which selected the combination).

If CAL? is sent with no numeric data element (*Nrf*) attached, then the instrument will assume that the input signal has that nominal value.

There are two ways to change the target value; either by the use of a numeric data element *Nrf* (described in the next paragraph), or by sending a 'NOMINAL' command before the CAL? query. Refer to page 5-85.

Nrf

is a decimal numeric data element representing the user-specific value which is to be assigned as target for the raw measured value. The difference between these two values is determines the correction factor.

The *Nrf* value is rounded to 7 digits resolution.

If the *Nrf* data element is included then *phs* is required. The target value must conform to the limits required for the intended calibration point.

Response Format:

A single ASCII character is returned.

Response Decode:

The value returned identifies the success or failure of the calibration operation:

Zero indicates **complete** with **no error** detected.

One indicates **error detected**. The error can be found in the device-dependent error queue.

Execution Errors

occur if calibration is not enabled, or if the number used for *Nrf* is incompatible with the setting being calibrated.

1002 Calibration disabled

1013 Data out of limit

Power On and Reset Conditions

Not applicable.

Set 'Nominal' Target Calibration Point

The NOMINAL command permits a user to select a non-default target value *before* using the CAL? calibration trigger query, avoiding the need to attach a numeric data element to the CAL? query.

Calibration Point Targeting

Selecting a combination of Function, Range, Magnitude band (and Frequency band if ACV or ACI) fixes a **default** calibration target value (of value denoted by the command which selected the combination). If CAL? is sent with no numeric data element (*Nrf*) attached, then the instrument will assume that the input signal has that default value.

The target value can be changed using the numeric data element *Nrf* attached to CAL? (see page 5-84).

A second method of changing the target value *before* triggering the calibration is provided for systems such as 'Wavetest', which do not allow undefined numeric data elements to be attached to query commands (as in this case *Nrf* with CAL?). This second method is by sending the 'NOMINAL' command *before* the CAL? query. This value can be recalled using the 'NOMINAL?' query (Page 5-86).

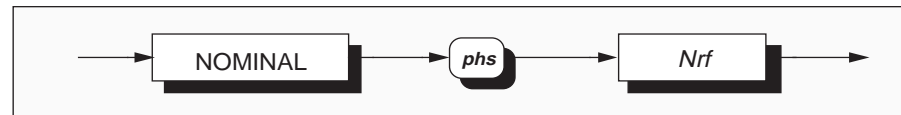

Nrf

is a decimal numeric data element representing the user-specific value which is to be assigned as target for the raw measured value. The difference between these two values determines the correction factor.

If the NOMINAL command is used, then the *Nrf* data element must be included, and *phs* is required. The target value must conform to the limits required for the intended calibration point.

The *Nrf* value is rounded to 7 digits resolution.

Execution Errors

occur if the number used is incompatible with the setting being calibrated.

1013 Data out of limit

Power On and Reset Conditions

Not applicable.

Recall the Value of the 'Nominal' Target Calibration Point

The NOMINAL? query returns the value of the active target calibration value.

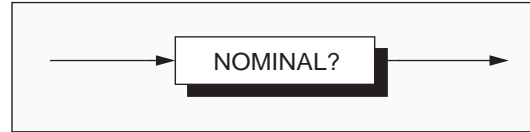

The target value could have been set up in one of three ways:

- as a default value on change of function, range, magnitude band or frequency band;
- as a non-default target value using the NOMINAL command *before* using the CAL? calibration trigger (Page 5-85);
- as a numeric data element (*Nrf*) attached to the CAL? query (Page 5-84).

Execution Errors

None.

Power On and Reset Conditions

Not applicable.

Response Format:

Character position

```

1 2 3 4 5 6 7 8 9 10 11 12 13 14
s n x x x n n n n E sg p p nl

```

Where:

- s = + or - or space
- n = 0 to 9
- x = either n or decimal point (.)
- E = ASCII character identifying the exponent
- sg = + or -
- p = 0 to 9 (exponent is in engineering units)
- nl = newline with EOI

Trigger Frequency 'Calibration'

The CAL_FREQ? command triggers the frequency calibration event. Optional selection of a user-specific non-nominal target value is also available. This value can be recalled using the 'NOM_FREQ?' query (Page 5-89).

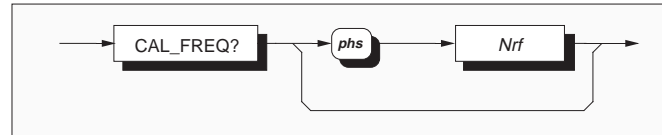

Calibration Point Targeting

The nominal cal point is 300Hz at, ideally, 1V or 10V. The amplitude of the signal is ignored. Frequency can be adjusted by $\pm 10\%$ of nominal.

If CAL? is sent with no numeric data element (*Nrf*) attached, then the instrument will assume that the input signal has the nominal frequency value.

There are two ways to change the target value; either by the use of a numeric data element *Nrf* (described in the next paragraph), or by sending a NOM_FREQ command before the CAL_FREQ? query. Refer to page 5-88.

Nrf

is a decimal numeric data element representing the user-specific value which is to be assigned as target for the raw measured value. The difference between these two values is determines the correction factor.

The *Nrf* value is rounded to 7 digits resolution.

If the *Nrf* data element is included then *pfs* is required. The target value must conform to the limits required for the intended calibration point.

Response Format:

A single ASCII character is returned.

Response Decode:

The value returned identifies the success or failure of the calibration operation:

Zero indicates **complete** with **no error** detected.

One indicates **error detected**. The error can be found in the device-dependent error queue.

Execution Errors

occur if calibration is not enabled, or if the number used for *Nrf* is incompatible with the setting being calibrated.

1002 Calibration disabled

1013 Data out of limit

Power On and Reset Conditions

Not applicable.

Set 'Nominal' Target Frequency Calibration Point

The NOM_FREQ command permits a user to select a non-default target value *before* using the CAL_FREQ? calibration trigger query, avoiding the need to attach a numeric data element to the CAL_FREQ? query.

Calibration Point Targeting

If CAL_FREQ? is sent with no numeric data element (*Nrf*) attached, then the instrument will assume that the input signal has the default value of 300Hz.

The target value can be changed using the numeric data element *Nrf* attached to CAL_FREQ? (see page 5-87).

A second method of changing the target value *before* triggering the calibration is provided for systems such as 'Wavetest', which do not allow undefined numeric data elements to be attached to query commands (as in this case *Nrf* with CAL_FREQ?). This second method is by sending the 'NOM_FREQ' command *before* the CAL_FREQ? query. This value can be recalled using the 'NOM_FREQ?' query (Page 5-89).

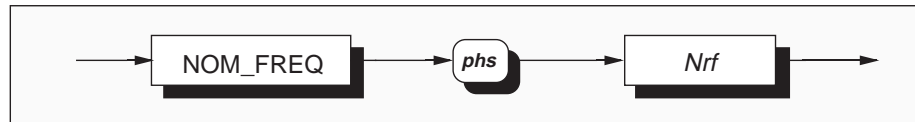

Nrf

is a decimal numeric data element representing the user-specific value which is to be assigned as target for the raw measured value. The difference between these two values determines the correction factor.

If the NOM_FREQ command is used, then the *Nrf* data element must be included, and *phs* is required. The target value must conform to the 10% limits required for the intended calibration point.

The *Nrf* value is rounded to 7 digits resolution.

Execution Errors

occur if the number used is incompatible with the setting being calibrated.

1013 Data out of limit

Power On and Reset Conditions

Not applicable.

Recall the Value of the 'Nominal' Target Frequency Calibration Point

The NOM_FREQ? query returns the value of the active target calibration value.

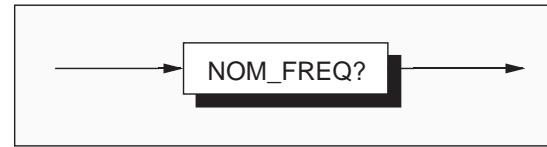

The target value could have been set up in one of two ways:

- as a non-default target value using the NOM_FREQ command *before* using the CAL_FREQ? calibration trigger (*Page 5-88*);
- as a numeric data element (*Nrf*) attached to the CAL_FREQ? query (*Page 5-87*).

Execution Errors

None.

Power On and Reset Conditions

Not applicable.

Response Format:

Character position

```

1 2 3 4 5 6 7 8 9 10 11 12 13 14
s n x x x n n n n E sg p p nl

```

Where:

s = + or - or space

n = 0 to 9

x = either n or decimal point (.)

E = ASCII character identifying the exponent

sg = + or -

p = 0 to 9 (exponent is in engineering units)

nl = newline with EOI

Set 10A Shunt Serial Number

This command allows a user to enter a string of up to 12 characters which form the serial number of the shunt to be used with the 10A range.

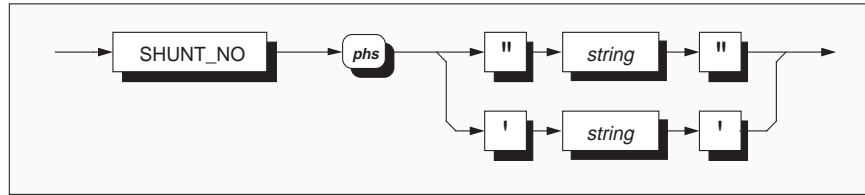

SHUNT_NO allows access to enter the shunt serial number.

string ASCII printing characters.

The shunt serial number is set in quotes so that a free format can be used for the number itself.

It can be recalled using the query SHUNT_NO?. Refer to *page 5-53*.

Normal Operating Mode

When used in normal operating mode the entered string is required to match the string which was stored, during calibration, into non-volatile RAM. If they do match, the instrument can be used in the 10A range.

Execution Error

In normal operating mode, if there is no match, then there is no access to the 10A range and the controller is alerted by an execution error:

1027 Shunt serial number incorrect.

Calibration Mode

When used in calibration mode this command will store the string in non-volatile RAM for subsequent comparisons. Note that there are additional correction factors stored during calibration of the 10V range which will be used for measurement correction on that range.

Execution Error

In order to enter calibration mode the ENBCAL command is sent, together with the rear-panel CALIBRATION switch set to the ENABLE position.

If, meanwhile, the calibration switch has been turned to DISABLE, the shunt serial number store cannot be written to and the controller is alerted by an execution error:

1002 Calibration disabled.

Power On and Reset Conditions

The shunt serial number is saved in non-volatile memory, so is not destroyed at Power Off.

After Power On the shunt serial number must be entered to gain access to the 10A range. Only one matched entry is necessary between power on and off (i.e. Reset does not clear the matched indicator).

Set 2-Wire Ohms lead Serial Number

This command allows a user to enter a string of up to 12 characters which form the serial number of the lead to be used for 2-wire Ohms measurement.

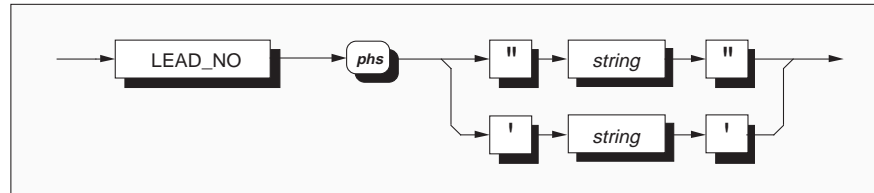

LEAD_NO allows access to enter the lead serial number.

string up to 12 ASCII printing characters.

The serial number is set in quotes so that a free format can be used for the number itself.

It can be recalled using the query LEAD_NO?. Refer to *page 5-55*.

Normal Operating Mode

When used in normal operating mode the entered string is required to match the string which was stored, during calibration, into non-volatile RAM. If they do match, 2-wire Ohms measurements can be made.

Execution Error

In normal operating mode, if there is no match, then there is no access to 2-wire Ohms measurement and the controller is alerted by an execution error:

1033 Lead serial number incorrect.

Calibration Mode

When used in calibration mode this command will store the string in non-volatile RAM for subsequent comparisons. Note that there are additional correction factors stored during 2-wire Ohms calibration which will be used for measurement correction.

Execution Error

In order to enter calibration mode the ENBCAL command is sent, together with the rear-panel CALIBRATION switch set to the ENABLE position.

If, meanwhile, the calibration switch has been turned to DISABLE, the lead serial number store cannot be written to and the controller is alerted by an execution error:

1002 Calibration disabled.

Power On and Reset Conditions

The lead serial number is saved in non-volatile memory, so is not destroyed at Power Off.

After Power On the lead serial number must be entered to access 2-wire ohms measurements. Only one matched entry is necessary between power on and off (i.e. Reset does not clear the matched indicator).

Characterize the Nominated Lead for 2-Wire Ohms Measurements

This command initiates measurement of the external resistance between the Hi and Lo terminals of the input connector. Two-wire Ohms measurement mode has been selected. The input cable assembly is plugged in; the Hi and Lo 4mm banana plugs are shorted together.

Certified calibration must be enabled for this command to be valid.

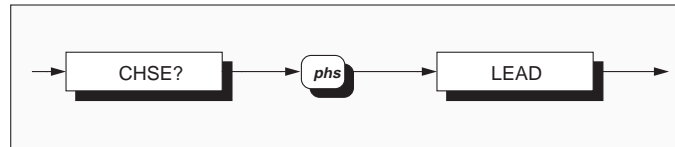

CHSE?_LEAD

Performs the lead-resistance measurement, and memorizes the value in non-volatile memory.

The lead serial number is also held in non-volatile memory (by the LEAD_NO command *page 5-91*)

For subsequent normal measurements, the instrument can be switched into 2-wire Ohms only after the correct lead serial number has been entered (LEAD_NO command *page 5-54*). Then for each 2-wire Ohms measurement, as the external circuit includes the leads, the stored lead resistance value is subtracted from the measured value.

Response Format:

A single ASCII character is returned.

Response Decode:

The value returned identifies the success or failure of the calibration operation:

Zero indicates **complete** with **no error** detected.

One indicates **error detected**. The error can be found in the device-dependent error queue.

Execution Error

In order to enter calibration mode the ENBCAL command is sent, together with the rear-panel CALIBRATION switch set to the ENABLE position.

If, meanwhile, the calibration switch has been turned to DISABLE, the lead characterization store cannot be written to and the controller is alerted by an execution error:

1002 Calibration disabled.

Power On and Reset Conditions

Not applicable.

Record the Nominal Ambient Temperature during Certified Calibration

This command can be used only when Certified Calibration is enabled. It enables users to enter the nominal ambient temperature value, which is then stored in non-volatile RAM.

Subsequently, when the instrument is in use; a user can recall the recorded value, and then: either reproduce the same ambient conditions, or use the value to calculate specification tolerances due to the temperature difference.

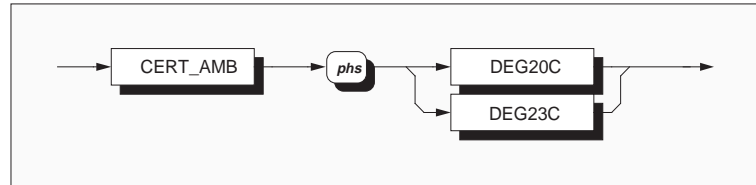

DEG20C records a nominal ambient temperature of 20°C.

DEG23C records a nominal ambient temperature of 23°C.

The recorded value can be recalled using the CERT_AMB? query (*page 5-56*).

Execution Error

In order to enter calibration mode the ENBCAL command is sent, together with the rear-panel CALIBRATION switch set to the ENABLE position.

If, meanwhile, the calibration switch has been turned to DISABLE, the CERT_AMB store cannot be written to and the controller is alerted by an execution error:

1002 Calibration disabled.

Power On and Reset Conditions

Not applicable.

Set Internal Clock/Calendar

This command can be used only when Certified Calibration is enabled. It enables users to reset the internal calendar clock to the 'present' date and time.

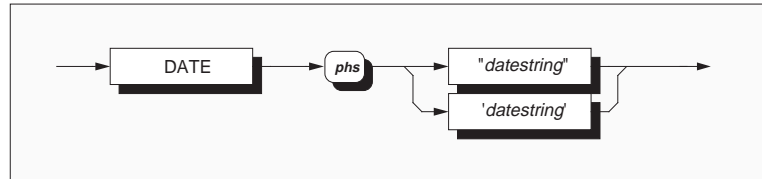

DATE

allows access to re-set the internal Calendar/Clock.

datestring This is a string of ASCII printing characters in the form:
 yyyy-mm-dd hr:nn

Where:

yyyy = a four-digit *year* followed by a hyphen

mmm = a three-character *month* followed by a hyphen

dd = a two-digit *day* followed by a space

Hr = a two-digit *24 hour* followed by a colon

nn = a two-digit *minute*.

The datestring is defined as a character sequence **only** in the format shown above. It is set in quotes so that the specified format can be used for the number itself.

Query TIME?

At any subsequent time, the query TIME? will return the current 'present time', which is derived by projecting the most-recently entered calendar/clock setting. Refer to *page 5-79* and *Section 4 page 4-7*.

The query DATE?, with no data elements, will return the current 'present date'. Refer to *page 5-57*.

Execution Errors

In order to enter calibration mode the ENBCAL command is sent, together with the rear-panel CALIBRATION switch set to the ENABLE position.

If, meanwhile, the calibration switch has been turned to DISABLE, the DATE store cannot be written to and the controller is alerted by an execution error:

1002 Calibration disabled.

If the datestring is not entered in the correct format shown opposite, then an execution error is generated:

1024 Invalid date format entered.

Power On and Reset Conditions

Not applicable.

Protected User Data

Entry of User Data

This command conforms to the IEEE 488.2 standard requirements.

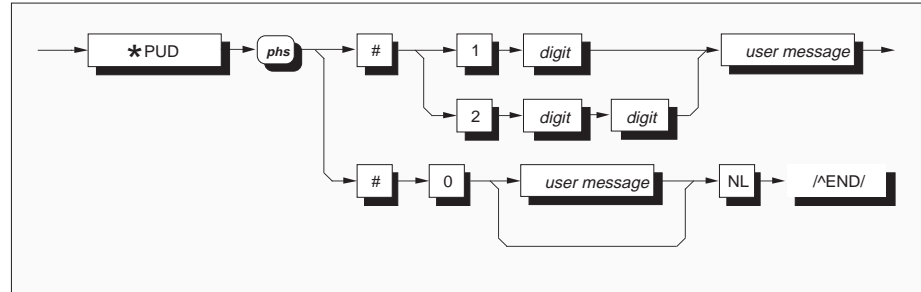

where:

phs = Program Header Separator,
digit = one of the ASCII-coded numerals,
user message = any message up to 63 bytes maximum.

*PUD

allows a user to enter up to 63 bytes of data into a protected area to identify or characterize the instrument. The two representations above are allowed depending on the message length and the number of 'digits' required to identify this. The instrument must be in calibration mode for this command to execute.

The data can be recalled using the ***PUD?** query. Refer to *page 5-78*.

Execution Error

In order to enter calibration mode the ENBCAL command is sent, together with the rear-panel CALIBRATION switch set to the ENABLE position.

If, meanwhile, the calibration switch has been turned to DISABLE, the protected user data store cannot be written to and the controller is alerted by an execution error:

1002 Calibration disabled.

Power On and Reset Conditions

Data area remains unchanged.

Exit from Calibration Mode

This command can be used only when Calibration is enabled. It enables users to exit from either Certified or Baseline calibration.

If the data element 'DATE' is used, the current (Certified or Baseline) calibration is annotated with the 'present' date from the internal calendar/clock. The calibration is also annotated with the internal ambient temperature, as sensed at the time.

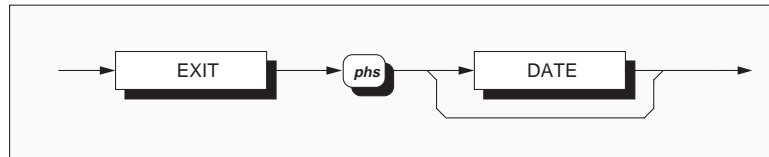

EXIT is the method of leaving either Certified or Baseline calibration mode.

DATE Annotates the current calibration with:

- a. The present date as stated by the internal calendar/clock;
- b. The internal ambient temperature, determined by the internal sensors.

Note that only the type of calibration which has just been finished (certified or baseline) will receive the date/temperature annotation. The other type will remain as annotated at its most recent calibration.

Query DATE?
At any subsequent time, the query DATE? can be used (with a parameter BASE or CERTIFIED) to return the date of the most-recent calibration of that type. Refer to *page 5-57*.

Query TEMP?
At any subsequent time, the query TEMP? can be used (with a parameter BASE or CERTIFIED) to return the internal ambient temperature at the most-recent calibration of that type. Refer to *page 5-56*.

Execution Errors
In order to enter calibration mode the ENBCAL command is sent, together with the rear-panel CALIBRATION switch set to the ENABLE position.

If, meanwhile, the calibration switch has been turned to DISABLE, the calibration date and temperature stores cannot be written to and the controller is alerted by an execution error:

1002 Calibration disabled.

Power On and Reset Conditions
Not applicable.

IEEE 488.2 Device Documentation Requirements

IEEE 488.2 requires that certain information be supplied to the user about how the device has implemented the standard. The Device Documentation Requirements are detailed in Section 4.9 of the Standard document, on *page 32*. In this handbook, the required information is already contained within the descriptions of the system, and this appendix provides cross-references to those descriptions in which it is presented. The following paragraphs have the same numbers as the paragraphs of Section 4.9 in the Standard document to which they refer.

1. The list of IEEE 488.1 Interface Functions subsets implemented is given as Table 5.1 (*page 5-2*). The list is also printed close to the IEEE 488 connector on the rear of the instrument.
2. The instrument address is set manually, and the instrument firmware refuses to set any address outside the range 0-30. It responds instead with a Data Entry Error, displayed on the front panel.
3. The (manual only) method of setting the address is described on *page 5-4*, including the point in time when the 4950 recognizes a user-initiated address change.
4. Appendix B to Section 5 describes the active and non-active settings at power-on.

5. Message Exchange Options:

- a. The Input Buffer is a first in - first out queue, which has a maximum capacity of 128 bytes (characters). Each character generates an interrupt to the instrument processor which places it in the Input Buffer for examination by the Parser. The characters are removed from the buffer and then translated with appropriate levels of syntax checking. If the rate of programming is too fast for the Parser or Execution Control, the buffer will fill up progressively. When the buffer is full, the handshake is held.
- b. No query returns more than one <RESPONSE MESSAGE UNIT>.
- c. All queries generate a response when parsed.
- d. No query generates a response when read.
- e. No commands are coupled.

6. The following functional elements are used in constructing the device-specific commands:

- Command Program Header
- Query Program Header
- Character Program Data
- Decimal Numeric Program Data.
- String Program Data (SHUNT_NO, LEAD_NO, DATE and SERIAL)
- Arbitrary Block Program Data (*PUD)

Compound Command Program Headers are not used.

7. *PUD blocks are limited to 63 bytes.
8. Expression Program Data elements are not used.
9. The syntax for each command is described in the general list of commands on *pages 5-28 to 5-96*. This list includes all queries, for which the response syntax is also described.
10. None. All device-to-device message transfer traffic follows the rules for <RESPONSE MESSAGE> elements.
11. The only command which elicits a Block Data response is the query *PUD?. Its response consists of #, 2, two digits and a data area of 63 bytes; 67 bytes in all.
12. A separate list of every implemented Common Command and Query is given in the alphabetical index at the start of Section 5.

They are also described in the general list on *pages 5-28 to 5-96*.
13. *CAL? is not implemented.
14. *DDT is not implemented.
15. Macro commands are not implemented.
16. *IDN? is described on *page 5-51*.
17. *PUD blocks are limited to 63 bytes.
18. Neither *RDT nor *RDT? are implemented.
19. The states affected by *RST are described for each command in the list of commands and queries on *pages 5-28 to 5-96*.

Query Command *LRN? is not implemented; neither are Commands *RCL and *SAV.
20. *TST? invokes the Confidence Selftest . The response to *TST? is described on *page 5-73*, with a list of possible errors detailed in Appendix A to Section 4 of this handbook.

The Maintenance Handbook Section 2 describes the nature of the tests applied and the resulting error codes for the Confidence Selftest.
21. The additional status data structures used in the instrument's status reporting are fully described on *pages 5-17 to 5-27*.

Operating instructions for the status reporting facilities are given on *pages 5-59 to 5-68*.
22. All commands are sequential - overlapped commands are not used.
23. As all commands are sequential, there are no pending parallel operations. The functional criterion which is met, therefore, is merely that the associated operation has been completed.

4950 Device Settings at Power On

Initial State at Power On

Consistent with its role, switching power on reminds us that the 4950 should not be used as a transfer standard until its temperature has stabilized. The first presentation on the menu (dot-matrix) display gives the time remaining to the end of the warm-up period, as shown:

The time starts from cold at 6 hours, and will count from 5hr 59min down to zero, before the display changes of its own accord.



4950 STABILITY EXPECTED IN : 05hr 59min

At any time during the warm-up period, this count-down display can be shown by pressing the front panel **Status** key. After warm-up is complete, the Status key will generate other status information as described on *pages 3-39 to 3-44*.

Power Down - Short Term

A short-term power down does not automatically reset the remaining warm-up period to 6 hours, although time will be added for the period of shut-down.

When power is removed, the switch-off time (t_s) and any remaining warm-up period (t_w) are saved. While the system is powered down, the clock continues to run, supported by the battery.

At power up time (t): the remaining warm-up time t_w is added to six times the difference between t and t_s , to obtain the new warm-up period (T):

$$T = 6(t - t_s) + t_w$$

After calculation, the following limits are applied to T :

minimum: 10 minutes
maximum: 5 hours 59 minutes

4950 Internal States at Power On

All the functions and facilities are configured into default states when power is turned on. These are shown in the following table. Refer to Section 5 for the corresponding IEEE 488.2 commands.

	DCV	ACV	Ohms	DCI	ACI
Range	1kV	1kV	100kΩ	1A	1A
Frequency Band	---	1kHz	---	---	300Hz
Measurement Band	0%	100%	0%	0%	100%

The active function is **DCV**, and so the active power-on defaults are:

Function: DCV. Range: 1kV. Measurement Band: 0%

Global Power-On and Reset Defaults:

Guard: Local. Trigger Source: External.
Accuracy Mode: High. Calibration: Disabled.
Corrections: Certified.

Specific Power-On and Reset Defaults:

2/4-wire Ohms 4-Wire
2-Wire Ohms Lead Serial No. Undefined, but the serial number of the lead which was characterized at the most-recent calibration is held in non-volatile RAM..

10A Shunt Serial No. Undefined, but the serial number of the shunt which was designated at the most-recent calibration is held in non-volatile RAM..

SECTION 6 SPECIFICATIONS

MECHANICAL

HEIGHT	88mm (3.5ins).
WIDTH	427mm (16.8ins).
DEPTH	487 max. (19.2ins).
WEIGHT	11.8kg (26 lbs).
RACK MOUNTING	Rack mounting ears to fit standard 19inch rack (ANSI-EIA-310-C). Conversion to accept 0.5inch wide slides.
RACK MOUNTING DEPTH	467mm (18.4ins).

ENVIRONMENTAL

AMBIENT TEMPERATURE	
Operating:	10°C to 40°C.
Non-Operating:	-40°C to 71°C

MAX RELATIVE HUMIDITY	
Operating (non-condensing):	
0°C to 30°C:	<95% ± 5%.
30°C to 40°C:	<75% ± 5%.
40°C to 50°C:	<45% ± 5%.

ELECTRICAL

POWER SUPPLY	Voltage: single-phase 100V - 130V or 200V - 260V selectable from rear panel. Line Frequency: 47 Hz to 63 Hz.
POWER CONSUMPTION	37 VA maximum.
WARM UP TIME	6 hours to full accuracy after power on.
TRANSFER STABILITY	See Transfer Stability specification tables.

SAFETY & EMI

SAFETY	Designed to UL1244; EN61010:1993/A2:1995
EMI	FCC Rules, Part 15, sub-part J: Limits A and B. VDE 0871: Limits A and B.

Maximum Input Voltages ⁽¹⁾

N.B. Both Peak and RMS input voltages should be limited to the maxima listed below.

Maximum Peak Input Voltages - DC and AC Voltage

Hi					
1600V	Lo				
360V	1600V	I+			
1600V	360V	1600V	I-		
1600V	360V	1600V	360V	Guard	
1600V	920V	1600V	920V	920V	Safety Ground ⁽²⁾ 
1600V	920V	1600V	920V	920V	Logic Ground ⁽²⁾

Maximum Peak Input Voltages - DC and AC Current; Resistance

Hi					
360V	Lo				
360V	360V	I+			
360V	360V	360V	I-		
360V	360V	360V	360V	Guard	
1300V	920V	1300V	920V	920V	Safety Ground ⁽²⁾ 
1300V	920V	1300V	920V	920V	Logic Ground ⁽²⁾

Maximum RMS Input Voltages - DC and AC Voltage

Hi					
1100V	Lo				
250V	1100V	I+			
1100V	250V	1100V	I-		
1100V	250V	1100V	250V	Guard	
1100V	650V	1100V	650V	650V	Safety Ground ⁽²⁾ 
1100V	650V	1100V	650V	650V	Logic Ground ⁽²⁾

Maximum RMS Input Voltages - DC and AC Current; Resistance

Hi					
250V	Lo				
250V	250V	I+			
250V	250V	250V	I-		
250V	250V	250V	250V	Guard	
900V	650V	900V	650V	650V	Safety Ground ⁽²⁾ 
900V	650V	900V	650V	650V	Logic Ground ⁽²⁾

Notes

- (1) Signals at any input during Self Test may affect performance of test.
- (2) Logic Ground is internally connected to Safety Ground.

TRANSFER SPECIFICATIONS

N.B. All specifications are valid only within the Measurement Band Span.

All specifications are valid only if the 4950 is used with its own individual characterized input connecting lead.

TCAL is the internal temperature recorded by the 4950 at exit from its most-recent Certified Calibration.

DC Voltage

Range	Measurement Band			Transfer Stability [3] TCAL ± 1°C ±(ppm)	Temperature Coefficient TCAL ± 5°C ±(ppm/°C)	MTS Control Software Uncertainties [5]	
	Band Name	Nominal Value	Band Span			MTS_CAL Cal. Uncertainty TCAL ± 1°C [3] ±(ppm)	CAL_CAL Uncertainty [4][6] TCAL ± 1°C ±(ppm)
100mV [8]	0% (Zero)	0V	-15mV to +15mV	---	---	---	---
	100%	+100mV [1] -100mV	+85mV to +115mV -115mV to -85mV	3.0 3.0	0.6 0.6	4.0 4.0	5.0 5.0
1V	0% (Zero)	0V	-0.1V to +0.1V	---	---	---	---
	100%	+1V [1] -1V	+0.9V to +1.1V -1.1V to -0.9V	1.5 1.5	0.5 0.5	2.2 2.2	2.6 2.6
10V	0% (Zero) 100%	0V	-1V to +1V	---	---	---	---
		+10V [1] -10V	+9V to +11V -11V to -9V	1.5 1.5	0.5 0.5	1.4 1.4	2.1 2.1
	190% (High)	+19V	+18V to +19.5V	1.5	0.5	1.8	2.3
		-19V	-19.5V to -18V	1.5	0.5	1.8	2.3
100V	0% (Zero)	0V	-10V to +10V	---	---	---	---
	100%	+100V [1] -100V	+90V to +110V -110V to -90V	2.0 2.0	0.8 0.8	2.0 2.0	2.9 2.9
1000V	0% (Zero)	0V	-100V to +100V	---	---	---	---
	100%	+1000V [1] -1000V	+900V to +1100V -1100V to -900V	2.0 2.0	0.8 0.8	2.0 2.0	2.9 2.9

Notes

- [1] The 100% band Nominal Value is also nominal 'Full Range' value (FR).
- [2] It is assumed that all zero DC offsets are removed before gain measurements are made.
This is true when under the control of the MTS_CAL and CAL_CAL programs of the automatic MTS Control Software.
- [3] Assumes a successful 4950 transportation loop closure.
- [4] Assumes a successful 4950 transportation loop closure within the 4950 30 day transfer specification.
- [5] a. MTS_CAL and CAL_CAL refer to the automatic MTS Control Software.
- [6] For calibrator calibration, the CAL_CAL tolerance is the combination of the Transfer Stability specification and the MTS_CAL uncertainty to 95% minimum confidence level.
- [7] Only when used in conjunction with the Model 4953 10A Shunt.
- [8] Millivolt Range(s): Band limits are ±15%, not 10%.

TRANSFER SPECIFICATIONS *(Contd.)*

N.B. All specifications are valid only within the Measurement Band Span and within the Frequency Band Span.

All specifications are valid only if the 4950 is used with its own individual characterized input connecting lead.

FCAL is the frequency within a band at which Certified Calibration of the 4950 was most-recently carried out.

TCAL is the internal temperature recorded by the 4950 at exit from its most-recent Certified Calibration.

AC Voltage

30 Day Transfer Stability \pm ppm of measurement band nominal value (within FCAL \pm 1%) (within TCAL \pm 1°C) [3]

Frequency Band		Range Measurement Band Name and Span								
Nominal	Span	1mV [1][8]	10mV [1][8]	100mV [1][8]	1V [1]	10V [1]		100V [1]	1000V [1]	
		100%	100%	100%	100%	100%	190%	100%	70%	100%
		0.85 - 1.15mV	8.5 - 11.5mV	85 - 115mV	0.9 - 1.1V	9 - 11V	18 - 19.5V	90 - 110V	600 - 800V	900 - 1100V
10Hz	9 - 11 Hz	20 + 2 μ V	20 + 2 μ V	20 + 2 μ V	10	10	---	10	---	15
20Hz	18 - 22 Hz	20 + 2 μ V	20 + 2 μ V	20 + 2 μ V	10	10	---	10	---	15
30Hz	27 - 33 Hz	20 + 2 μ V	20 + 2 μ V	20 + 2 μ V	10	10	---	10	---	15
40Hz	36 - 44 Hz	20 + 2 μ V	20 + 2 μ V	20 + 2 μ V	10	10	---	10	---	15
55Hz †	46.25 - 63.75 Hz	20 + 2 μ V	20 + 2 μ V	20 + 2 μ V	10	10	---	10	---	15
300Hz †	270 - 440 Hz	20 + 2 μ V	20 + 2 μ V	20 + 2 μ V	10	10	---	10	---	15
1kHz	0.9 - 1.1 kHz	20 + 2 μ V	20 + 2 μ V	20 + 2 μ V	10	10	10	10	---	15
10kHz	9 - 11 kHz	20 + 2 μ V	20 + 2 μ V	20 + 2 μ V	10	10	---	10	---	15
20kHz	18 - 22 kHz	20 + 2 μ V	20 + 2 μ V	20 + 2 μ V	10	10	---	10	---	15
30kHz	27 - 33 kHz	20 + 2 μ V	20 + 2 μ V	20 + 2 μ V	10	10	---	10	---	15
50kHz	45 - 55 kHz	30 + 2 μ V	30 + 2 μ V	30 + 2 μ V	20	20	---	20	50	---
100kHz	90 - 110 kHz	50 + 3 μ V	50 + 3 μ V	50 + 3 μ V	30	30	---	30	50	---
200kHz	180 - 220 kHz	---	---	---	---	---	---	50	---	---
300kHz	270 - 330 kHz	100 + 3 μ V	100 + 3 μ V	100 + 3 μ V	70 ‡	70 ‡	---	---	---	---
500kHz	450 - 550 kHz	200 + 3 μ V	200 + 3 μ V	200 + 3 μ V	100 ‡	100 ‡	---	---	---	---
1MHz	0.9 - 1.1 MHz	300 + 3 μ V	300 + 3 μ V	300 + 3 μ V	200 ‡	200 ‡	---	---	---	---

† Frequency bandwidths extended to include common power-supply frequencies. (50Hz & 60Hz on 55Hz band; 400Hz on 300Hz band)

‡ Figures apply to both 4-wire and 2-wire connections

Notes

[1] The 100% band Nominal Value is also nominal 'Full Range' value (FR).

[2] It is assumed that all zero DC offsets are removed before gain measurements are made.

This is true when under the control of the MTS_CAL and CAL_CAL programs of the automatic MTS Control Software.

[3] Assumes a successful 4950 transportation loop closure.

[4] Assumes a successful 4950 transportation loop closure within the 4950 30 day transfer specification.

[5] MTS_CAL and CAL_CAL refer to the automatic MTS Control Software.

[6] For calibrator calibration, the CAL_CAL tolerance is the combination of the Transfer Stability specification and the MTS_CAL uncertainty to 95% minimum confidence level.

[7] Only when used in conjunction with the Model 4953 10A Shunt.

[8] Millivolt Range(s): Band limits are \pm 15%, not 10%.

AC Voltage

Temperature Coefficient ±ppm of measurement band nominal value/°C (within FCAL ± 1%) (within TCAL ± 5°C)

Frequency Band		Range								
Nominal	Span	Measurement Band Name and Span								
		1mV [1][8]	10mV [1][8]	100mV [1][8]	1V [1]	10V [1]		100V [1]	1000V [1]	
		100% 0.85 - 1.15mV	100% 8.5 - 11.5mV	100% 85 - 115mV	100% 0.9 - 1.1V	100% 9 - 11V	190% 18 - 19.5V	100% 90 - 110V	70% 600 - 800V	100% 900 - 1100V
10Hz	9 - 11 Hz	1	1	1	1	1	---	2	---	2
20Hz	18 - 22 Hz	1	1	1	1	1	---	2	---	2
30Hz	27 - 33 Hz	1	1	1	1	1	---	2	---	2
40Hz	36 - 44 Hz	1	1	1	1	1	---	2	---	2
55Hz†	46.25 - 63.75 Hz	1	1	1	1	1	---	2	---	2
300Hz †	270 - 440 Hz	1	1	1	1	1	---	2	---	2
1kHz	0.9 - 1.1 kHz	1	1	1	1	1	1	2	---	2
10kHz	9 - 11 kHz	1	1	1	1	1	---	2	---	2
20kHz	18 - 22 kHz	1	1	1	1	1	---	2	---	2
30kHz	27 - 33 kHz	1	1	1	1	1	---	2	---	2
50kHz	45 - 55 kHz	5	5	5	5	5	---	5	8	---
100kHz	90 - 110 kHz	5	5	5	5	5	---	5	8	---
200kHz	180 - 220 kHz	---	---	---	---	---	---	10	---	---
300kHz	270 - 330 kHz	5	5	5	10 ‡	10 ‡	---	---	---	---
500kHz	450 - 550 kHz	40	40	40	40 ‡	40 ‡	---	---	---	---
1MHz	0.9 - 1.1 MHz	40	40	40	40 ‡	40 ‡	---	---	---	---

† Frequency bandwidths extended to include common power-supply frequencies. (50Hz & 60Hz on 55Hz band; 400Hz on 300Hz band)

‡ Figures apply to both 4-wire and 2-wire connections

TRANSFER SPECIFICATIONS *(Contd.)*

N.B. All specifications are valid only within the Measurement Band Span and within the Frequency Band Span.

All specifications are valid only if the 4950 is used with its own individual characterized input connecting lead.

FCAL is the frequency within a band at which Certified Calibration of the 4950 was most-recently carried out.

TCAL is the internal temperature recorded by the 4950 at exit from its most-recent Certified Calibration.

AC Voltage: MTS Control Software Uncertainties ^{[3][5]}:

MTS_CAL Uncertainties ±ppm of measurement band nominal value (within FCAL ± 1%) (within TCAL ± 1°C)

Frequency Band		Range Measurement Band Name and Span								
Nominal	Span	1mV [1][8]	10mV [1][8]	100mV [1][8]	1V [1]	10V [1]		100V [1]	1000V [1]	
		100%	100%	100%	100%	100%	190%	100%	70%	100%
		0.85 - 1.15mV	8.5 - 11.5mV	85 - 115mV	0.9 - 1.1V	9 - 11V	18 - 19.5V	90 - 110V	600 - 800V	900 - 1100V
10Hz	9 - 11 Hz	277*	156*	117*	36	36	---	41	---	---
20Hz	18 - 22 Hz	277	156	117	36	36	---	41	---	---
30Hz	27 - 33 Hz	277	156	117	36	36	---	41	---	---
40Hz	36 - 44 Hz	277	156	117	24	24	---	36	---	---
55Hz	46.25 - 63.75 Hz	277	156	117	24	24	---	36	---	37
300Hz	270 - 440 Hz	260	136	89	24	24	---	26	---	37
1kHz	0.9 - 1.1 kHz	260	136	89	24	24	24	26	---	37
10kHz	9 - 11 kHz	277	156	103	24	24	---	26	---	42
20kHz	18 - 22 kHz	293	166	117	24	24	---	26	---	47
30kHz	27 - 33 kHz	387	239	190	24	26	---	29	---	74
50kHz	45 - 55 kHz	387	239	190	31	26	---	35	110	---
100kHz	90 - 110 kHz	616	403	356	37	26	---	64	344	---
200kHz	180 - 220 kHz	---	---	---	---	---	---	239*	---	---
300kHz	270 - 330 kHz	748*	581*	579*	96 ‡	83 ‡	---	---	---	---
500kHz	450 - 550 kHz	769*	608*	607*	202 ‡	184 ‡	---	---	---	---
1MHz	0.9 - 1.1 MHz	1057*	947*	945*	557 ‡	527 ‡	---	---	---	---

† Frequency bandwidths extended to include common power-supply frequencies. (50Hz & 60Hz on 55Hz band; 400Hz on 300Hz band)

‡ Figures apply to both 4-wire and 2-wire connections

* Uncertainties marked with an asterisk (*) are estimated but not fully traceable.

Notes

[1] The 100% band Nominal Value is also nominal 'Full Range' value (FR).

[2] It is assumed that all zero DC offsets are removed before gain measurements are made.

This is true when under the control of the MTS_CAL and CAL_CAL programs of the automatic MTS Control Software.

[3] Assumes a successful 4950 transportation loop closure.

[4] Assumes a successful 4950 transportation loop closure within the 4950 30 day transfer specification.

[5] MTS_CAL and CAL_CAL refer to the automatic MTS Control Software.

[6] For calibrator calibration, the CAL_CAL tolerance is the combination of the Transfer Stability specification and the MTS_CAL uncertainty to 95% minimum confidence level

[7] Only when used in conjunction with the Model 4953 10A Shunt.

[8] Millivolt Range(s): Band limits are ±15%, not 10%.

AC Voltage: MTS Control Software Uncertainties [5]:

CAL_CAL Uncertainties ±ppm of measurement band nominal value (within FCAL ± 1%) (within TCAL ± 1°C) [4][6]

Frequency Band		Range								
Nominal	Span	Measurement Band Name and Span								
		1mV [1][8]	10mV [1][8]	100mV [1][8]	1V [1]	10V [1]		100V [1]	1000V [1]	
		100% 0.85 - 1.15mV	100% 8.5 - 11.5mV	100% 85 - 115mV	100% 0.9 - 1.1V	100% 9 - 11V	190% 18 - 19.5V	100% 90 - 110V	70% 600 - 800V	100% 900 - 1100V
10Hz	9 - 11 Hz	277 + 2µV*	157 + 2µV*	119 + 2µV*	38	38	---	42	---	---
20Hz	18 - 22 Hz	277 + 2µV	120 + 2µV	119 + 2µV	38	38	---	42	---	---
30Hz	27 - 33 Hz	277 + 2µV	157 + 2µV	119 + 2µV	38	38	---	42	---	---
40Hz	36 - 44 Hz	277 + 2µV	157 + 2µV	119 + 2µV	26	26	---	38	---	---
55Hz	46.25 - 63.75 Hz	277 + 2µV	157 + 2µV	119 + 2µV	26	26	---	38	---	40
300Hz	270 - 440 Hz	261 + 2µV	138 + 2µV	91 + 2µV	26	26	---	28	---	40
1kHz	0.9 - 1.1 kHz	261 + 2µV	138 + 2µV	91 + 2µV	26	26	26	28	---	40
10kHz	9 - 11 kHz	277 + 2µV	157 + 2µV	105 + 2µV	26	26	---	28	---	44
20kHz	18 - 22 kHz	294 + 2µV	167 + 2µV	119 + 2µV	26	26	---	28	---	49
30kHz	27 - 33 kHz	387 + 2µV	240 + 2µV	191 + 2µV	26	28	---	31	---	75
50kHz	45 - 55 kHz	388 + 2µV	241 + 2µV	192 + 2µV	37	33	---	40	121	---
100kHz	90 - 110 kHz	618 + 3µV	406 + 3µV	359 + 3µV	47	40	---	71	348	---
200kHz	180 - 220 kHz	---	---	---	---	---	---	244*	---	---
300kHz	270 - 330 kHz	754 + 3µV*	590 + 3µV*	588 + 3µV*	119 ‡	109 ‡	---	---	---	---
500kHz	450 - 550 kHz	794 + 3µV*	641 + 3µV*	639 + 3µV*	226 ‡	209 ‡	---	---	---	---
1MHz	0.9 - 1.1 MHz	1099 + 3µV*	993 + 3µV*	992 + 3µV*	591 ‡	564 ‡	---	---	---	---

† Frequency bandwidths extended to include common power-supply frequencies. (50Hz & 60Hz on 55Hz band; 400Hz on 300Hz band)

‡ Figures apply to both 4-wire and 2-wire connections

* Uncertainties marked with an asterisk (*) are estimated but not fully traceable.

TRANSFER SPECIFICATIONS (Contd.)

N.B. All specifications are valid only within the Measurement Band Span and within $\pm 1\%$ of the Frequency Band Nominal Frequency.
 All specifications are valid only if the 4950 is used with its own individual characterized input connecting lead.
 TCAL is the internal temperature recorded by the 4950 at exit from its most-recent Certified Calibration.

Ohms

30 Day Transfer \pm ppm of measurement band nominal value [2]

Range	Measurement Band			Transfer Stability [3] TCAL $\pm 1^\circ\text{C}$ \pm (ppm)	Temperature Coefficient TCAL $\pm 5^\circ\text{C}$ \pm (ppm/ $^\circ\text{C}$)	MTS Control Software Uncertainties [5]	
	Band Name	Nominal Value	Band Span			MTS_CAL Cal. Uncertainty [3] TCAL $\pm 1^\circ\text{C}$ \pm (ppm)	CAL_CAL Uncertainty [4][6] TCAL $\pm 1^\circ\text{C}$ \pm (ppm)
10Ω	0%	Zero	Zero to 1 Ω	---	---	---	---
	10%	1 Ω	Zero to 2 Ω	20	1.2	7.7*	9.2*
	30%	3 Ω	2 Ω to 4 Ω	15	1.2	7.7*	9.2*
	100% (FR)	10 Ω [1]	9 Ω to 11 Ω	5	1.2	7.7	9.2
	190%	19 Ω	18.0 Ω to 19.5 Ω	5	1	7.7*	9.2*
100Ω	0%	Zero	0 Ω to 10 Ω	---	---	---	---
	30%	30 Ω	20 Ω to 40 Ω	3	1	5.6*	6.4*
	100% (FR)	100 Ω [1]	90 Ω to 110 Ω	3	1	5.6	6.4
	190%	190 Ω	180 Ω to 195 Ω	3	1	5.6*	6.4*
1kΩ	0%	Zero	0k Ω to 0.1k Ω	---	---	---	---
	30%	300 Ω	0.2k Ω to 0.4k Ω	3	1	3.0*	4.3*
	100% (FR)	1k Ω [1]	0.9k Ω to 1.1k Ω	3	1	3.0	4.3
	190%	1.9k Ω	1.8k Ω to 1.95k Ω	3	1	3.0*	4.3*
10kΩ	0%	Zero	0k Ω to 1k Ω	---	---	---	---
	30%	3k Ω	2k Ω to 4k Ω	3	1	2.9*	4.2*
	100% (FR)	10k Ω [1]	9k Ω to 11k Ω	3	1	2.9	4.2
	190%	19k Ω	18k Ω to 19.5k Ω	3	1	2.9*	4.2*
100kΩ	0%	Zero	0k Ω to 10k Ω	---	---	---	---
	30%	30k Ω	20k Ω to 40k Ω	5	1	5.5*	7.4*
	100% (FR)	100k Ω [1]	90k Ω to 110k Ω	5	1	5.5	7.4
	190%	190k Ω	180k Ω to 195k Ω	5	1	5.5*	7.4*
1MΩ	0%	Zero	0M Ω to 0.1M Ω	---	---	---	---
	30%	300k Ω	0.2M Ω to 0.4M Ω	8	1.5	10.9*	13.5*
	100% (FR)	1M Ω [1]	0.9M Ω to 1.1M Ω	8	1.5	10.9	13.5
	190%	1.9M Ω	1.8M Ω to 1.95M Ω	8	1.5	10.9*	13.5*
10MΩ	0%	Zero	0M Ω to 1M Ω	---	---	---	---
	30%	3M Ω	2M Ω to 4M Ω	12	2	20.4*	23.6*
	100% (FR)	10M Ω [1]	9M Ω to 11M Ω	12	2	20.4	23.6
	190%	19M Ω	18M Ω to 19.5M Ω	12	2	20.4*	23.6*
100MΩ	0%	Zero	0M Ω to 10M Ω	---	---	---	---
	30%	30M Ω	20M Ω to 40M Ω	180	20	82.3*	197.9*
	100% (FR)	100M Ω [1]	90M Ω to 110M Ω	180	20	82.3	197.9

* Uncertainties marked with an asterisk (*) are estimated but not fully traceable.

DC Current

30 Day Transfer ±ppm of measurement band nominal value [2]

Range	Measurement Band			Transfer Stability [3]	Temperature Coefficient	MTS Control Software Uncertainties [5]	
	Band Name	Nominal Value	Band Span			MTS_CAL Cal. Uncertainty [3]	CAL_CAL Uncertainty [4][6]
				TCAL ± 1°C ±(ppm)	TCAL ± 5°C ±(ppm/°C)	TCAL ± 1°C ±(ppm)	TCAL ± 1°C ±(ppm)
100µA	0% (Zero)	0A	-10µA to +10µA	---	---	---	---
	100% (FR)	+100µA [1]	+90µA to +110µA	7	10	20.1	21.3
		-100µA	-110µA to -90µA	7	10	20.1	21.3
1mA	0% (Zero)	0A	-0.1mA to +0.1mA	---	---	---	---
	100% (FR)	+1mA [1]	+0.9mA to +1.1mA	7	10	10.7	12.8
		-1mA	-1.1mA to -0.9mA	7	10	10.7	12.8
10mA	0% (Zero)	0A	-1mA to +1mA	---	---	---	---
	100% (FR)	+10mA [1]	+9mA to +11mA	7	10	10.3	12.5
		-10mA	-11mA to -9mA	7	10	10.3	12.5
100mA	0% (Zero)	0A	-10mA to +10mA	---	---	---	---
	100% (FR)	+100mA [1]	+90mA to +110mA	7	10	14.6	16.2
		-100mA	-110mA to -90mA	7	10	14.6	16.2
1A	0% (Zero)	0A	-0.1A to +0.1A	---	---	---	---
	100% (FR)	+1A [1]	+0.9A to +1.1A	15	10	24.1	28.4
		-1A	-1.1A to -0.9A	15	10	24.1	28.4
10A [7]	0% (Zero)	0A	-1A to +1A	---	---	---	---
	100% (FR)	+10A [1]	+9A to +11A	20	10	54.3	57.8
		-10A	-11A to -9A	20	10	54.3	57.8

Notes

- [1] The 100% band Nominal Value is also nominal 'Full Range' value (FR).
- [2] It is assumed that all zero DC offsets are removed before gain measurements are made.
This is true when under the control of the MTS_CAL and CAL_CAL programs of the automatic MTS Control Software.
- [3] Assumes a successful 4950 transportation loop closure.
- [4] Assumes a successful 4950 transportation loop closure within the 4950 30 day transfer specification.
- [5] MTS_CAL and CAL_CAL refer to the automatic MTS Control Software.
- [6] For calibrator calibration, the CAL_CAL tolerance is the combination of the Transfer Stability specification and the MTS_CAL uncertainty to 95% minimum confidence level
- [7] Only when used in conjunction with the Model 4953 10A Shunt.

TRANSFER SPECIFICATIONS *(Contd.)*

N.B. All specifications are valid only within the Measurement Band Span and within the Frequency Band Span.

All specifications are valid only if the 4950 is used with its own individual characterized input connecting lead.

FCAL is the frequency within a band at which Certified Calibration of the 4950 was most-recently carried out.

TCAL is the internal temperature recorded by the 4950 at exit from its most-recent Certified Calibration.

AC Current

30 Day Transfer Stability \pm ppm of measurement band nominal value (within FCAL \pm 1%) (within TCAL \pm 1°C) [3]

Frequency Band		Range					
Nominal	Span	Measurement Band Name and Span					
		100 μ A [1] 100% 90 μ A-110 μ A	1mA [1] 100% 0.9mA-1.1mA	10mA [1] 100% 9mA-11mA	100mA [1] 100% 90mA-110mA	1A [1] 100% 0.9A-1.1A	10A [1][7] 100% 9A-11A
10Hz	9Hz - 11Hz	50	40	40	40	40	200*
20Hz	18Hz - 22Hz	50	40	40	40	40	200*
30Hz	27Hz - 33Hz	50	40	40	40	40	200*
40Hz	36Hz - 44Hz	50	40	40	40	40	200
55Hz †	46.25Hz-63.75Hz	50	40	40	40	40	200
300Hz †	270Hz - 440Hz	50	40	40	40	40	200
1kHz	0.9kHz - 1.1kHz	50	40	40	40	40	200
5kHz	4.5kHz - 5.5kHz	100	70	70	70	70	300
10kHz	9kHz - 11kHz	300*	200*	200*	200*	200*	600
20kHz	18kHz - 22kHz	300	300	300	300	300	1000*
30kHz	27kHz - 33kHz	500	500	500	500	500	---

† Frequency bandwidths extended to include common power-supply frequencies. (50Hz & 60Hz on 55Hz band; 400Hz on 300Hz band)

* Uncertainties marked with an asterisk (*) are estimated but not fully traceable.

Notes

[1] The 100% band Nominal Value is also nominal 'Full Range' value (FR).

[2] It is assumed that all zero DC offsets are removed before gain measurements are made.

This is true when under the control of the MTS_CAL and CAL_CAL programs of the automatic MTS Control Software.

[3] Assumes a successful 4950 transportation loop closure.

[4] Assumes a successful 4950 transportation loop closure within the 4950 30 day transfer specification.

[5] MTS_CAL and CAL_CAL refer to the automatic MTS Control Software.

[6] For calibrator calibration, the CAL_CAL tolerance is the combination of the Transfer Stability specification and the MTS_CAL uncertainty to 95% minimum confidence level

[7] Only when used in conjunction with the Model 4953 10A Shunt.

AC Current

Temperature Coefficient ±ppm of measurement band nominal value/°C (within FCAL ± 1%) (within TCAL ± 5°C)

Frequency Band		Range					
Nominal	Span	Measurement Band Name and Span					
		100µA [1] 100% 90µA-110µA	1mA [1] 100% 0.9mA-1.1mA	10mA [1] 100% 9mA-11mA	100mA [1] 100% 90mA-110mA	1A [1] 100% 0.9A-1.1A	10A [1][7] 100% 9A-11A
10Hz	9Hz - 11Hz	20	20	20	20	20	40*
20Hz	18Hz - 22Hz	20	20	20	20	20	40*
30Hz	27Hz - 33Hz	20	20	20	20	20	40*
40Hz	36Hz - 44Hz	20	20	20	20	20	40
55Hz †	46.25Hz-63.75Hz	20	20	20	20	20	40
300Hz †	270Hz - 440Hz	20	20	20	20	20	40
1kHz	0.9kHz - 1.1kHz	20	20	20	20	20	40
5kHz	4.5kHz - 5.5kHz	20	20	20	20	20	50
10kHz	9kHz - 11kHz	30*	30*	30*	30*	30*	80
20kHz	18kHz - 22kHz	70	70	70	70	70	120*
30kHz	27kHz - 33kHz	90	90	90	90	90	---

† Frequency bandwidths extended to include common power-supply frequencies. (50Hz & 60Hz on 55Hz band; 400Hz on 300Hz band)
 * Uncertainties marked with an asterisk (*) are estimated but not fully traceable.

TRANSFER SPECIFICATIONS *(Contd.)*

N.B. All specifications are valid only within the Measurement Band Span and within the Frequency Band Span.

All specifications are valid only if the 4950 is used with its own individual characterized input connecting lead.

FCAL is the frequency within a band at which Certified Calibration of the 4950 was most-recently carried out.

TCAL is the internal temperature recorded by the 4950 at exit from its most-recent Certified Calibration.

AC Current: MTS Control Software Uncertainties [3][5]:

MTS_CAL Uncertainties ±ppm of measurement band nominal value (within FCAL ± 1%) (within TCAL ± 1°C)

Frequency Band		Range					
Nominal	Span	Measurement Band Name and Span					
		100µA [1] 100% 90µA-110µA	1mA [1] 100% 0.9mA-1.1mA	10mA [1] 100% 9mA-11mA	100mA [1] 100% 90mA-110mA	1A [1] 100% 0.9A-1.1A	10A [1][7] 100% 9A-11A
10Hz	9Hz - 11Hz	122	117	113	113	165	235*
20Hz	18Hz - 22Hz	122	117	113	113	165	235*
30Hz	27Hz - 33Hz	107	101	96	96	157	234*
40Hz	36Hz - 44Hz	85	80	75	75	109	212
55Hz †	46.25Hz-63.75Hz	85	80	75	75	109	196
300Hz †	270Hz - 440Hz	85	80	75	75	109	196
1kHz	0.9kHz - 1.1kHz	85	80	75	75	109	196
5kHz	4.5kHz - 5.5kHz	129	123	115	115	212	257
10kHz	9kHz - 11kHz	300*	260*	260*	260*	260*	337
20kHz	18kHz - 22kHz	330*	285*	285*	285*	285*	1200*
30kHz	27kHz - 33kHz	400*	350*	350*	350*	350*	---

† Frequency bandwidths extended to include common power-supply frequencies. (50Hz & 60Hz on 55Hz band; 400Hz on 300Hz band)

* Uncertainties marked with an asterisk (*) are estimated but not fully traceable.

Notes

[1] The 100% band Nominal Value is also nominal 'Full Range' value (FR).

[2] It is assumed that all zero DC offsets are removed before gain measurements are made.

This is true when under the control of the MTS_CAL and CAL_CAL programs of the automatic MTS Control Software.

[3] Assumes a successful 4950 transportation loop closure.

[4] Assumes a successful 4950 transportation loop closure within the 4950 30 day transfer specification.

[5] MTS_CAL and CAL_CAL refer to the automatic MTS Control Software.

[6] For calibrator calibration, the CAL_CAL tolerance is the combination of the Transfer Stability specification and the MTS_CAL uncertainty to 95% minimum confidence level

[7] Only when used in conjunction with the Model 4953 10A Shunt.

AC Current: MTS Control Software Uncertainties [5]:**CAL_CAL Uncertainties** \pm ppm of measurement band nominal value (within FCAL \pm 1%) (within TCAL \pm 1°C) [4][6]

Frequency Band		Range					
Nominal	Span	Measurement Band Name and Span					
		100 μ A [1] 100% 90 μ A-110 μ A	1mA [1] 100% 0.9mA-1.1mA	10mA [1] 100% 9mA-11mA	100mA [1] 100% 90mA-110mA	1A [1] 100% 0.9A-1.1A	10A [1][7] 100% 9A-11A
10Hz	9Hz - 11Hz	132	124	120	120	170	308*
20Hz	18Hz - 22Hz	132	124	120	120	170	308*
30Hz	27Hz - 33Hz	118	109	104	104	162	308*
40Hz	36Hz - 44Hz	99	90	85	85	116	292
55Hz †	46.25Hz-63.75Hz	99	90	85	85	116	280
300Hz †	270Hz - 440Hz	99	90	85	85	116	280
1kHz	0.9kHz - 1.1kHz	99	90	85	85	116	280
5kHz	4.5kHz - 5.5kHz	163	142	134	134	223	395
10kHz	9kHz - 11kHz	550*	450*	450*	450*	385*	688
20kHz	18kHz - 22kHz	550*	465*	465*	465*	610*	1600*
30kHz	27kHz - 33kHz	550*	515*	515*	515*	480*	---

† Frequency bandwidths extended to include common power-supply frequencies. (50Hz & 60Hz on 55Hz band; 400Hz on 300Hz band)

* Uncertainties marked with an asterisk (*) are estimated but not fully traceable.

Composition of Overall Tolerance of Transfer Measurements

Applying Temperature Coefficients

The amount of additional uncertainty, due to the temperature difference between the current internal temperature and that of Certified calibration (TCAL), needs to be combined with that of the Transfer Stability, to arrive at the overall tolerance of a traceable transfer measurement.

Extent of Traceability

The Transfer Stability specification is valid within $\pm 1^\circ\text{C}$ of TCAL, with no addition for temperature difference. Outside this temperature range, and extending to TCAL $\pm 5^\circ\text{C}$, the uncertainty due to the temperature difference is given as the Temperature Coefficient. Beyond TCAL $\pm 5^\circ\text{C}$, measurements are not considered to be traceable.

With this in mind, the definition of TCAL, and the alternative methods used to measure and record it, are as follows:

Definition of TCAL

In the context of these specifications, TCAL is the internal temperature at the most-recent Certified calibration of the 4950. It is normally written into non-volatile RAM during exit from Calibration mode, by one of two automatic methods:

1. Front Panel Operation

Section 4, pages 4-35 and 4-40.

By pressing the **Exit** soft key in the CAL menu, then the **Yes** soft key in the UPDATE CAL DATE/TEMP ON EXIT? menu.

2. Remote Operation

Section 5, page 5-96.

By sending the **DATE** data element as part of the EXIT Command when exiting Calibration mode.

Temperatures and Calculated Temperature Differences

Although TCAL has been measured and recorded, it does not need to be used directly in the calculation of overall transfer tolerance. What is required is the difference between the current temperature and TCAL. This is calculated in internal software and can be found by front panel or remote operations as detailed below:

1. Front Panel Operation

Section 4: Monitor group of menus:

Page 4-6 shows how to open the INTERNAL TEMP: menu to give the measured current internal temperature (and the external ambient temperature - "CERT AMB" - which was entered by the user at the most-recent Certified calibration).

Page 4-6 also gives the method of opening the TEMP DIFF: menu to give the the differences between the measured current internal temperature and:

- a. that measured at Baseline calibration (BASE).
- b. that measured at Certified calibration (CERT). This is called T_d under "Definitions" below.

2. Remote Operation

Section 5: Instrument Configuration:

Page 5-56 shows the **CERT_AMB?** command which obtains a response giving the external ambient temperature which was entered by the user at the most-recent Certified calibration.

Page 5-56 also shows the **TEMP?** command which obtains a response giving either:

- a. the measured current internal temperature,
- b. the difference between the current internal temperature and that measured at Baseline calibration (**BASE**),
- c. the difference between the current internal temperature and that measured at the most-recent Certified calibration (**CERT**). This is called T_d under "Definitions" below.

Calculating the Overall Tolerance

The overall tolerance is a combination of two types of uncertainty (the Transfer Stability and the uncertainty due to temperature difference from that at Certified calibration).

The method aims to achieve a 99.9%-safe tolerance.

Definitions**Uncertainty Contribution of the Temperature Difference**

The basic Transfer Stability specification extends out to TCAL $\pm 1^\circ\text{C}$. To determine how much of the difference in internal temperature between current use and Certified calibration will contribute uncertainty to the overall tolerance:

Measured current internal temperature is (T_i)

Measured internal temperature at Certified calibration was (TCAL)

Temperature difference (T_d) $T_d = T_i - \text{TCAL}$

T_d can be found by the local or remote means described earlier.

As the basic Transfer Stability specification is valid out to TCAL $\pm 1^\circ\text{C}$, the only portion of the temperature difference which contributes to uncertainty is ($|T_d| - 1$) $^\circ\text{C}$ when this expression is positive.

The contribution can be found by reading the temperature coefficient from the relevant specification for Function/Range/Measurement Band/Frequency Band (in ppm of measurement band nominal value / $^\circ\text{C}$) and multiplying it by ($|T_d| - 1$) $^\circ\text{C}$. The result will be in ppm of the measurement band nominal value.

Method of Combining Uncertainties

Uncertainties should be combined using a two-part calculation. The method described can produce a 99.9% confidence level (i.e. the probability of an erroneous tolerance is one part per thousand).

The method combines the worst-case arithmetic summation result with the Root-Sum-of-Squares (RSS) result, in a geometric mean.

Uncertainties to be combined: $= E_1, E_2, E_3, \dots$

Worst-case arithmetic summation (Σ):

$$\Sigma = E_1 + E_2 + E_3 + \dots$$

Root-Sum-of-Squares: $\text{RSS} = \sqrt{(E_1^2 + E_2^2 + \dots)}$

Combination with 99.9% safe description of the overall tolerance:
 $= \sqrt{(\Sigma \times \text{RSS})}$

See Overleaf for Examples:

Examples of Combining Uncertainties:

Example 1:

Function: DC Voltage
 Range: 10V
 Calibration point: +10V
 Reference: Page 6-3:

Current internal temperature (T_i):
 $T_i = 21.6^\circ\text{C}$

Temperature at Certified calibration (TCAL):
 TCAL = 23.2°C

Temperature difference (Cert) (T_d):
 $T_d = -1.6^\circ\text{C}$
 (T_d can be found directly by the local or remote means described earlier.)

Transfer Stability
 $(E_1) = \pm 1.5\text{ppm}$

Temperature Coeff. = $\pm 0.5\text{ppm}/^\circ\text{C}$

Temperature Difference to be applied:
 $|T_d| - 1 = |-1.6| - 1$
 = **0.6°C**

Uncertainty due to Temp. Difference (read from the Temperature Coefficient table and multiplied by ($|T_d| - 1$):
 $0.6^\circ\text{C} \times 0.5\text{ppm}/^\circ\text{C} = \mathbf{0.3\text{ppm}}$

Worst-case summation:
 $\Sigma = 1.5 + 0.3$
 = **1.8**

Root-Sum-of-Squares:
 $\text{RSS} = \sqrt{(1.5^2 + 0.3^2)}$
 = **1.53ppm**

Geometric mean:
 = $\sqrt{(1.8 \times 1.53)}$
 = **1.66ppm**

Example 2:

Function: AC Voltage
 Range: 100V
 Calibration point: +100V @ 200kHz
 Reference: Pages 6-4 and 6-5:

Current internal temperature (T_i):
 $T_i = 22.4^\circ\text{C}$

Temperature at Certified calibration (TCAL):
 TCAL = 19.7°C

Temperature difference (Cert) (T_d):
 $T_d = 2.7^\circ\text{C}$
 (T_d can be found directly by the local or remote means described earlier.)

Transfer Stability
 $(E_1) = \pm 50\text{ppm}$

Temperature Coeff. = $\pm 10\text{ppm}/^\circ\text{C}$

Temperature Difference to be applied:
 $|T_d| - 1 = |2.7| - 1$
 = **1.7°C**

Uncertainty due to Temp. Difference (read from the Temperature Coefficient table and multiplied by ($|T_d| - 1$):
 $1.7^\circ\text{C} \times 10\text{ppm}/^\circ\text{C} = \mathbf{17\text{ppm}}$

Worst-case summation:
 $\Sigma = 50 + 17$
 = **67**

Root-Sum-of-Squares:
 $\text{RSS} = \sqrt{(50^2 + 17^2)}$
 = **52.8ppm**

Geometric mean:
 = $\sqrt{(67 \times 52.8)}$
 = **59.5ppm**

Other Specifications

Sample Size and Resolution

Funct.	Range	Sample Size (internal readings)		Resolution (digits)	
		Low Acc.	High Acc.	Low Acc.	High Acc.
DCV	100mV	4	128	6.5	7.5
	1V-1000V	4	64	6.5	7.5
ACV	1mV	1	8	4.5	5.5
	10mV-1000V	1	8	5.5	6.5
Ohms	10 Ω	4	128	6.5	7.5
	100 Ω - 1M Ω	4	64	6.5	7.5
	10M Ω & 100M Ω	4	128	6.5	7.5
DCI	100 μ A-10A	1	32	5.5	6.5
ACI	100 μ A-10A	1	8	5.5	6.5

SECTION 7 SPECIFICATION VERIFICATION

Introduction

General

Under normal circumstances the 4950 will be used within an automatic system. The control software package provides for baseline verification during normal operations (as pre- and post-transportation performance checks).

Pre- and Post-Transportation Comparisons

As a Multifunction Transfer Standard, the 4950 is required to maintain its 'Transfer Stability' specification for a period up to, but not exceeding 30 days from its most-recent 'Certified Calibration'.

Traceability is transferred from a Standards Laboratory to a User's Calibration Laboratory by

- a. performing a 'Certified Calibration' on the 4950 at the Standards Laboratory.
- b. physically moving the 4950 between the two laboratories.
- c. using the 4950 to calibrate the calibrator at the User's calibration Laboratory.

To check that its stability specification has been maintained during the process, the 4950 is subjected to two 'baseline' comparisons *against the same stable source*, before and after the journey.

These comparisons are described in outline (two scenarios) in *Section 1, pages 1-2 to 1-5*. Please refer back to these pages before proceeding.

'Transfer Verification'

In order to verify that the instrument conforms to its specification (i.e. its transfer stability is maintained), it is necessary to perform the Pre-transportation and Post-transportation comparison programs, separated by a period of 30 days.

Following both the 'Pre- and Post-transportation' comparison procedures, the MTS Control Software will generate two files, one containing the Pre-transportation comparison figures, and the other containing the difference between the Pre-transportation and Post-transportation comparisons. If the difference between corresponding figures is out of limits, then 'Transfer Verification' will be deemed to have been unsuccessful.

Comparison Results

Refer to the MTS Control Software User's Handbook.

SECTION 8 CERTIFIED CALIBRATION

Introduction

General

Under normal circumstances the 4950 will be used within an automatic system. The MTS Control Software package provides for certified calibration as an integral function of the 4950 normal operation. It is expected that the instrument, almost exclusively, will be calibrated under the direction of this software. Therefore this section is included only for those occasions when the use of the MTS Control Software is inappropriate.

IMPORTANT: The following procedures allow the 4950 to be recalibrated to external calibration standards. To verify the 4950's performance to specification without affecting the instrument's calibration memory, refer to Section 7 of this handbook.

Autocal

The 4950's Autocal feature allows full control of external calibration, either from the unit's front panel controls or via its integral IEEE-488.2 bus interface. The Autocal feature eliminates the thermal disturbance that would occur if the instrument's covers had to be removed during calibration, and it greatly speeds up the calibration process.

To perform autocalibration, appropriate calibration inputs are applied to the 4950 for each of its measurement and frequency bands. As each of these inputs is applied to the instrument, a single depression of the front-panel 'Caltrig' key or an appropriate IEEE-488.2 calibration command causes the 4950 to calculate an appropriate digital calibration constant, which is stored in non-volatile memory within the instrument. These calibration constants are subsequently used to correct the output of the 4950's internal A/D converter so that the instrument provides accurate measurements of the input signal.

The 4950 automatically assumes that the target value is the nominal calibration point for the band. Provision is also made for the user to enter the true value of the calibration source where this differs from the nominal calibration point.

Access to the Autocal function is protected by a rear-panel slide switch. This switch must be set to the 'Enable' position before the autocal feature can be operated.

It is not always necessary to perform a full range of calibration procedures. Because each of the 4950's ranges and bands can be calibrated separately, without affecting other ranges and bands; the 4950 can be partially recalibrated if required.

The calibration procedures detailed in this section assume that the required values are available as a direct calibration source for the 4950. No further instructions are given as to the means of setting up those values.

General Outline of Calibration Operations

Detailed descriptions of the individual operations available in Certified Calibration mode appear in earlier sections as follows:

Section 4: Manual (front panel) calibration menus and keys: pages 4-34 to 4-40.

Section 5: IEEE 488 calibration command codes and queries: pages 5-80 to 5-96.

The program overview of the CAL group of menus, shown in *Section 4 page 4-35*, is repeated opposite for convenience. The manual calibration process generally conforms to a set sequence of operations, using the menu selections shown in the overview. This section is a guide to these sequences.

The CAL Menu

Front Panel Cal key

Pressing the front-panel **Cal** key, with the rear-panel **CALIBRATION** switch set to the **ENABLE** position, opens the **CAL** menu as illustrated opposite.

IMPORTANT:

While the **CAL** menu or any of its menu options is displayed, the **Caltrig** key is enabled, and when pressed alters the contents of the calibration memory. To avoid the risk of inadvertently overwriting previous calibration data, the **Caltrig** key should be used only for genuine calibration operations.

The **CAL** menu provides the following functions:

Set

The **Set** menu option allows the operator to enter the known value of a calibration input where this differs from the nominal value. **Set** must be used immediately prior to use of the **Caltrig** key.

Freq

The **SET_FREQ** menu option allows a particular calibration source frequency to be entered as target value for frequency calibration, using the numeric keyboard.

Date

The **Date** menu option allows modification of the current date, using the numeric keyboard.

Amb

The **Amb** menu option allows either 20°C or 23°C to be recorded (as the temperature to which the ambient at Certified Calibration is closest).

Lead

The **Lead** key calibrates the input cable assembly for use in Ohms mode. Certain enabling selections must be preset.

Spcl

This key is used to enter Baseline calibration mode, and should not be used except during manufacture and by repair formations.

Exit

This key is used to close calibration mode. It opens an update menu as shown opposite.

Front Panel Config Key

When in Calibration mode, the **Config** key and menu are used to assign an input lead and a 4953 10A Shunt to this particular 4950 by registering their serial numbers in non-volatile memory.

Further Information

Refer to *Section 4* for more information about the **CAL** menu options. The relevant pages are shown in the overview opposite.

Preparation

Familiarization and Safety

WARNING THIS INSTRUMENT CAN DELIVER A LETHAL ELECTRIC SHOCK. NEVER TOUCH ANY LEAD OR TERMINAL UNLESS YOU ARE ABSOLUTELY CERTAIN THAT NO DANGEROUS VOLTAGE IS PRESENT.



SEE THE SAFETY ISSUES SECTION AT THE FRONT OF THIS MANUAL.

Environment and Warm-Up

Set up the calibration equipment in a stable environment at $23^{\circ}\text{C} \pm 1^{\circ}\text{C}$ or $20^{\circ}\text{C} \pm 1^{\circ}\text{C}$, power on and allow to stabilize for the required warm-up periods. The 4950 should be allowed to stabilize until the 6-hour warm-up period has expired.

Confidence Selftest

Ensure that the input lead is disconnected from the 4950 front panel.

Select the **TEST** menu by pressing the front-panel **Test** key and select the **Conf** (Confidence Test) menu option. Allow the operational self-test to run to completion, at which point the 4950 should display:

CONFIDENCE TEST COMPLETED

If during the operational self-test the 4950 displays a four-figure number starting with 2 (Confidence Test Unsuccessful) the unit probably has a fault. In this case, note the number and contact your local service centre.

Enter Calibration Mode

1. Set the rear-panel **CALIBRATION** switch to the **ENABLE** position.
2. Press the front-panel **Cal** key to display the **CAL** menu.

Check the Date and Time

1. In the **CAL** menu, press the **Date** soft key to obtain the **DATE/TIME** menu.

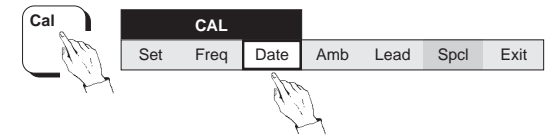

yyyy = 4-character year
 mm = 2-character month
 dd = 2-character day
 hh = 2-character hour (24 hr clock)
 mm = 2-character minute

2. Check the date and time shown on the dot-matrix display. If correct, press **Quit** to return to the **CAL** menu.
3. If required, correct the display using the numeric keyboard, referring to *Section 4, page 4-37*. When correct, press **Enter** to return to the **CAL** menu.

General Sequence for Full Instrument Calibration

(NB. to meet user's need, just one range on one function can be calibrated)

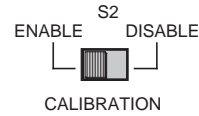

Slide the rear panel CALIBRATION switch to ENABLE.



Press Cal key to open CAL menu and Enter Calibration mode - Front Panel Cal annunciator lit.

Caution: The Caltrig key is enabled!



ACV 1V/10V Range: Signal within 100% measurement band
 Signal Frequency: Set to Default 300Hz or Nominated Frequency 300Hz-400Hz.
 Adjustment: ±10% of set frequency



10V Range: 0%, 100% and 190%
 Other Ranges: 0% and 100%.



10V range: 100% and 190% @1kHz.
 1kV range: 1kV or 700V on all frequency bands.
 Other ranges: 100% on all frequency bands.



All Ranges: 0% and 100%
 (10A Range requires 10A shunt Model 4953)



All Ranges: 100% of range on all Frequency Bands.
 (10A Range requires 10A shunt Model 4953)



10Ω Range: 0%, 10%, 30%, 100% and 190%
 100MΩ Range: 0%, 30% and 100%
 Other Ranges: 0%, 30%, 100% and 190%



Request Exit from Calibration mode and CAL menu.
 Update Requested for Temperature and Reference values as required.
 Calibration mode terminated - Front Panel Cal annunciator extinguished.
 Caltrig key is disabled.

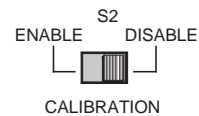

Slide the rear panel CALIBRATION switch to DISABLE.

Calibration Setup

Enter Calibration Mode

The following procedures represent the recommended order of calibration, giving all the necessary setting-up commands.

1. Ensure that all equipment is correctly warmed-up, and that the 4950 has successfully completed its 'Confidence' selftest. *Refer to page 8-4.*
2. Ensure that the rear-panel CALIBRATION switch is set to 'ENABLE'.

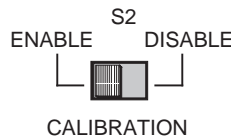

3. Press the front-panel **Cal** key to enter the CAL menu.



The Legend lights on the Main (Left-hand) Display.

Caution: The Caltrig key is enabled!

Certified Corrections

When in Calibration mode (and with 'Spcl' not selected), the 4950 forces Certified corrections ON, so there is no need to set 'ON' manually. In any case, the front-panel **Cert** key is disabled.

Input Lead Serial Number

1. With the CAL menu displayed, press the front-panel **Config** key to obtain the CAL CONFIG menu.

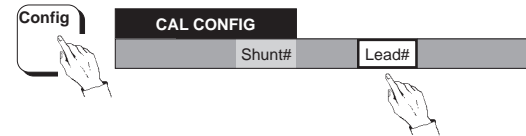

2. In the CAL CONFIG menu, press the soft **Lead#** key to obtain the LEAD SER # menu.



3. Check that the serial number marked on the 4950 input cable assembly is the same as that displayed on the dot-matrix display. If the numbers match, press the **Quit** soft key to return to the CAL CONFIG menu. If not, consult the local Calibration Manager, as the new Ohms lead will require 2-wire Ohms characterization. *Refer to page 8-23.*
4. After consultation, if it is required to change cable assemblies, the serial number of the new cable should be entered before characterization using the numeric keyboard. The new number will appear on the dot-matrix display. To record this number, press the **Enter** soft key. The display returns to the CAL CONFIG menu.

10A Shunt Serial Number

In the event that calibration of the 4950 10A Range is required, the designated model 4953 10A Shunt serial number must be recorded in 4950 memory. Then for subsequent use of the range to calibrate a calibrator, the actual and recorded numbers will match.

1. Press the front-panel **Config** key to obtain the CAL CONFIG menu.

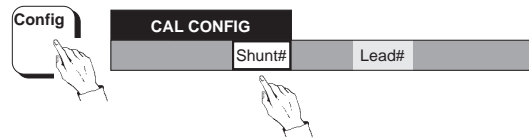

2. In the CAL CONFIG menu, press the soft **Shunt#** key to obtain the SHUNT SER # menu.



3. Check that the serial number marked on the Model 4953 10A Shunt is the same as that displayed on the dot-matrix display. If the numbers match, press the **Quit** soft key to return to the CAL CONFIG menu. If the numbers do not match, consult the system manager, as there may be some administrative problem.
4. After consultation, if it is required to calibrate the 10A range using a different shunt, the serial number of the new shunt can be entered using the numeric keyboard. The new number will appear on the dot-matrix display. To record this number in non-volatile memory, press the **Enter** soft key. The dot-matrix display returns to the CAL CONFIG menu.

Record the Ambient Temperature

The external ambient temperature of the calibration laboratory should be recorded in 4950 memory; so that in any subsequent calibration of a calibrator, errors due to thermal difference can be taken into account.

1. Revert to the CAL menu by pressing the front panel **Cal** key.

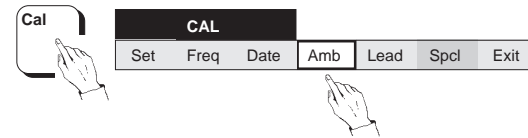

2. In the CAL menu, press the **Amb** soft key to obtain the NOMINAL CAL AMBIENT (CERT) menu.



3. Decide whether the local lab temperature is closer to 20°C or 23°C. In the NOMINAL CAL AMBIENT (CERT) menu, press the appropriate soft key.
4. Revert to the CAL menu by pressing the front panel **Cal** key.

Nominal and Non-Nominal Target Values

The above 'Calibration Setup' actions will have set conditions for the 4950 to be calibrated. Nominal values of measurement bands can now be calibrated directly.

Target values at other than nominal will require the use of the **Set** facility in the CAL menu.

Frequency Calibration

Initial 4950 Setup

Connect 4950 to Calibration Source

WARNING



THIS INSTRUMENT CAN DELIVER A LETHAL ELECTRIC SHOCK. NEVER TOUCH ANY LEAD OR TERMINAL UNLESS YOU ARE ABSOLUTELY CERTAIN THAT NO DANGEROUS VOLTAGE IS PRESENT.

1. Ensure that the calibration source OUTPUT is OFF and Local Guard is selected.
2. Connect the 4950 to the calibration source.

To Calibrate Frequency at 300Hz on the ACV 1V range at 1V.

After the initial setup and connecting up, use the following general sequence to calibrate the frequency.

Frequency Calibration Procedure

4950

Press the **ACV** key to obtain the *ACV ranges* menu:

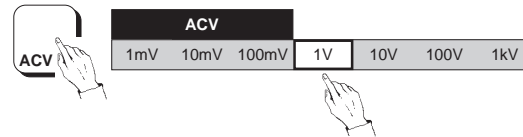

Press the **1V range** soft key to obtain the 1V range's default *frequency bands* menu.

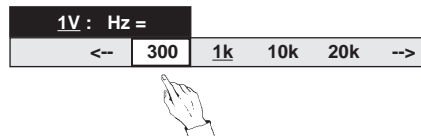

Press the **300** soft key to select the 300Hz frequency band.

Calibration Source

Select ACV output of 1V at 300Hz.

Set Output **ON**.

4950

Press the **Cal** key to see the CAL menu.

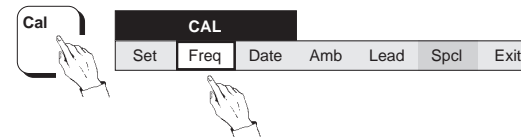

Select **Freq** to obtain the SET FREQ menu.

The SET FREQ menu always shows the nominal frequency for the band. e.g:



Press the **Enter** key.

Press **Caltrig**. Calibration is complete when the **Busy** legend goes out.

Calibration Source

Set Output **OFF**.

To Calibrate at a Local Standard Frequency (300-400Hz).

After the initial setup and connecting up, use the following general sequence to calibrate the frequency.

Frequency Calibration Procedure

Calibration Source

Set to the local 300Hz - 400Hz standard frequency at the nominal output voltage for the 100% band of one of the 4950 ranges (1V or 10V is preferable).

4950

Press the **ACV** key to obtain the ACV ranges menu (defaulted to 1kV range):

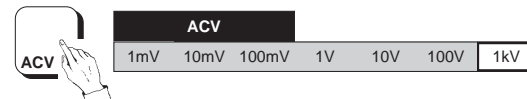

Press the appropriate *range* soft key which corresponds to the Calibration Source output. This will obtain that range's default *frequency bands* menu:

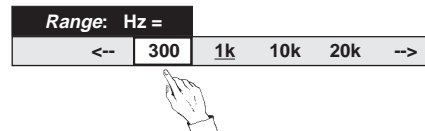

Press the **300** soft key to select the 300Hz frequency band (this frequency band extends from 270Hz to 440Hz, which allows for the permitted $\pm 10\%$ adjustment on 300-400Hz).

Calibration Source

Set Output **ON**.

4950

Press the **Cal** key to see the CAL menu:

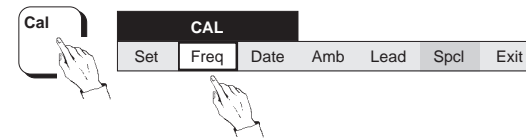

Select **Freq** to obtain the SET FREQ menu. The SET FREQ menu always shows the nominal frequency for the band. e.g:



Using the **numeric** keys, **key in** the true output frequency of the standard, then press the **Enter** key.

Press **Caltrig**. Calibration is complete when the **Busy** legend goes out.

Calibration Source

Set Output **OFF**.

DC Voltage Calibration

Initial 4950 Setup

1. Press the **DCV** key; select the **100mV** range.

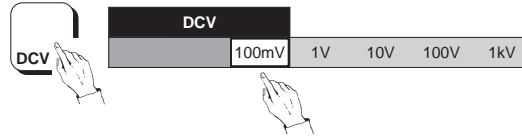

Connect 4950 to Calibration Source

WARNING THIS INSTRUMENT CAN DELIVER A LETHAL ELECTRIC SHOCK. NEVER TOUCH ANY LEAD OR TERMINAL UNLESS YOU ARE ABSOLUTELY CERTAIN THAT NO DANGEROUS VOLTAGE IS PRESENT.



1. Ensure that the calibration source **OUTPUT** is **OFF** and **Local Guard** is selected.
2. Connect the 4950 to the calibration source.

To Calibrate DC Voltage at Nominal or Non-Nominal Values

After the initial setup and connecting up, use the following general sequence to calibrate the bands as shown on the table opposite. Do not calibrate $\pm 100\%$ or $\pm 190\%$ bands without first having calibrated their corresponding 0% band to the source zero. Just one range can be calibrated if required, but for a full calibration start with the 100mV range and work up to the 1kV range.

Nominal: To calibrate at Nominal values, **omit** the operations in the shaded boxes .

Non-Nominal: The **Set** feature allows a user to enter the true output value of the calibration standard where it differs from nominal full range or zero. In this case **include** the shaded operations .

4950 Automatic \pm Band Selection

When calibrating DCV 100% and 190% bands, there is no facility to select band polarity. The 4950 recognizes the input polarity and automatically selects the appropriate positive or negative version of the selected band.

Calibration Source Zeros

Before calibrating any 4950 range, ensure that for calibration sources with positive and negative outputs, both positive and negative zero outputs have the same value.

Band Calibration Procedure

4950

Press the **DCV** key to obtain the DCV *ranges* menu.

Press the required *range* soft key to obtain that range's *measurement bands* menu.

Press the required *band* soft key to select the *required measurement band*.

Calibration Source

Select required output for the band.
Set Output **ON**.

4950

Press the **Cal** key to see the CAL menu.



Select **Set** to obtain the SET VALUE menu.
The SET VALUE menu always shows the nominal value for the band. e.g:



Using the **numeric** keys, **key in** the true output value of the standard, then press the **Enter** key.

4950

Press **Caltrig**. Calibration is complete when the **Busy** legend goes out.

Calibration Source

Set Output **OFF**.

Range	Band	Target Value
100mV	0%	0mV
100mV	+100%	+100mV
100mV	-100%	-100mV
1V	0%	0V
1V	+100%	+1V
1V	-100%	-1V
10V	0%	0V
10V	+100%	+10V
10V	+190%	+19V
10V	-100%	-10V
10V	-190%	-19V
100V	0%	0V
100V	+100%	+100V
100V	-100%	-100V
1kV	0%	0kV
1kV	+100%	+1kV
1kV	-100%	-1kV

DC Voltage Calibration Procedure - Recommended Sequence to Calibrate Ranges and Bands

AC Voltage Calibration

Initial 4950 Setup

1. Press the **ACV** key; select the **1mV** range.

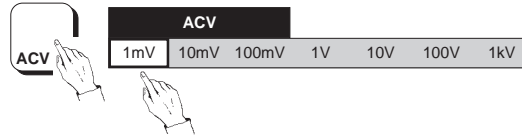

Connect 4950 to Calibration source

WARNING THIS INSTRUMENT CAN DELIVER A LETHAL ELECTRIC SHOCK. NEVER TOUCH ANY LEAD OR TERMINAL UNLESS YOU ARE ABSOLUTELY CERTAIN THAT NO DANGEROUS VOLTAGE IS PRESENT.



1. Ensure that the calibration source **OUTPUT** is **OFF** and **Local Guard** is selected.
2. Connect the 4950 to the calibration source.

To Calibrate AC Voltage at Nominal or Non-Nominal Values

After the initial setup and connecting up, calibrate the ranges. Use the sequence of frequency bands shown in the table, repeating the band calibration procedure for each band. Just one range can be calibrated if required; but for a full calibration, start with the 1mV range and work up to the 1kV range.

Nominal: To calibrate at Nominal values, **omit** the operations in the shaded boxes .

Non-Nominal: The **Set** feature allows a user to enter the true output value of the calibration standard where it differs from nominal.

In this case **include** the shaded operations .

Band Calibration Procedure

4950

Press the **ACV** key to obtain the ACV *ranges* menu.

Press the required *range* soft key to obtain that range's *frequency bands* menu.

Press the required *frequency* soft key to select the required *frequency band*.

Note: On the 10V range at 1kHz, there are two measurement bands at 100% and 190%. These should both be calibrated, 100% first, using the appropriate selection in the 10V 1kHz menu

Calibration Source

Select the required frequency and output target value for the band.

Set Output **ON**. *

4950

Press the **Cal** key to see the CAL menu.

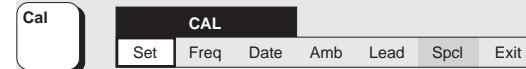

Select **Set** to obtain the SET VALUE menu. The SET VALUE menu always shows the nominal value for the band. e.g:



Using the **numeric** keys, **key in** the true output value of the standard, then press the **Enter** key.

4950

Press **Caltrig**. Calibration is complete when the **Busy** legend goes out.

Calibration Source

Set Output **OFF**.

AC Voltage Calibration Procedure - Recommended Sequence to Calibrate Ranges and Frequency Bands							
<i>Work down the left-hand column in sequence from top to bottom, then move to the next column, and so on. Use Nominal 100% Range values unless otherwise stated.</i>							
Ranges:	1mV	10mV	100mV	1V	10V	100V	1kV
Frequency	1kHz	1kHz	1kHz	1kHz	1kHz (10V & 19V)	1kHz	1kHz
Bands	1MHz	1MHz	1MHz	1MHz	1MHz	200kHz	30kHz
	10Hz	10Hz	10Hz	10Hz	10Hz	10Hz	10Hz
	20Hz	20Hz	20Hz	20Hz	20Hz	20Hz	20Hz
	30Hz	30Hz	30Hz	30Hz	30Hz	30Hz	30Hz
	40Hz	40Hz	40Hz	40Hz	40Hz	40Hz	40Hz
	55Hz	55Hz	55Hz	55Hz	55Hz	55Hz	55Hz
	300Hz	300Hz	300Hz	300Hz	300Hz	300Hz	300Hz
	10kHz	10kHz	10kHz	10kHz	10kHz	10kHz	10kHz
	20kHz	20kHz	20kHz	20kHz	20kHz	20kHz	20kHz
	30kHz	30kHz	30kHz	30kHz	30kHz	30kHz	-
	50kHz	50kHz	50kHz	50kHz	50kHz	50kHz	50kHz @ 700V*
	100kHz	100kHz	100kHz	100kHz	100kHz	100kHz	100kHz @ 700V*
	300kHz	300kHz	300kHz	300kHz	300kHz	200kHz	-
	500kHz	500kHz	500kHz	500kHz	500kHz	-	-

* On the 1kV range at 700V, allow the input multiplier to stabilize thermally for 10 minutes.

DC Current Calibration - 100 μ A to 10A Ranges

Use of Model 4953 10A Shunt

Rationale

In order to calibrate the 10A range, it is necessary to use a Model 4953 10A shunt.

If traceability is to be maintained, it is essential that same shunt be used when making any subsequent 10A range measurements. For this reason, the serial number of the particular shunt used for calibration is placed into 4950 non-volatile memory, and the DCI 10A range is locked out and cannot be activated unless:

- a. **Shunt#** has been pre-selected in either the DCI CONFIG or ACI CONFIG menu, and then:
- b. the serial number of the shunt used to calibrate the 10A range has been entered in the SHUNT SER # menu.

The recorded serial number of the shunt can be viewed using the STATUS CONFIG menu.

In this section, two procedures are given:

1. Entry of the 4953 10A Shunt serial number.
2. Calibration of DCI 100 μ A to 10A ranges.

N.B. The same shunt is used both for DCI and ACI measurements. Procedure (1) may already have been carried out for AC Current calibration.

Identify the Model 4953 10A Shunt

Press the **DCI** key; select the **100 μ A** range.

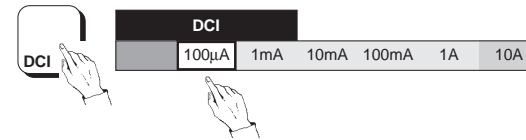

Press the front panel **Cal** key to obtain the CAL menu.



Press the front panel **Config** key to obtain the CAL CONFIG menu.

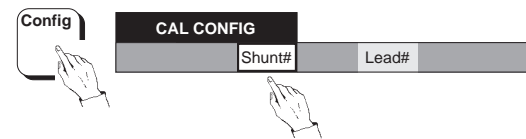

Press the soft **Shunt#** key to obtain the SHUNT SER # menu.



Check that the serial number marked on the 4953 shunt is the same as that shown on the dot-matrix display. If the numbers match, press the **Quit** soft key to return to the CAL CONFIG menu. If the numbers do not match, consult your Calibration Manager, as there may be some administrative problem.

After consultation, if it is required to calibrate the 10A range using a different shunt, write the serial number of the new shunt into the SHUNT SER # menu using the **numeric keyboard**.

Unlock the 10A Range

Press the front panel **DCI** key to obtain the DCI *ranges* menu.

Press the front panel **Config** key to obtain the DCI CONFIG menu.

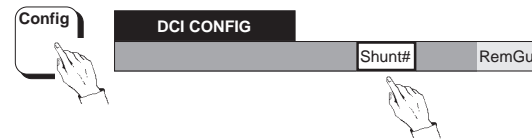

Press the soft **Shunt#** key for the SHUNT SER # menu.



Use the **numeric keyboard** to write the serial number of the correct 10A shunt into the SHUNT SER # menu.

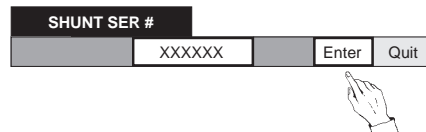

Press the soft **Enter** key to unlock the 10A range.

Continued overleaf

100 μ A to 10A Calibration

Initial 4950 Setup

1. Press the **DCI** key; select the **100 μ A** range.

Connect 4950 to Calibration Source

WARNING THIS INSTRUMENT CAN DELIVER A LETHAL ELECTRIC SHOCK. NEVER TOUCH ANY LEAD OR TERMINAL UNLESS YOU ARE ABSOLUTELY CERTAIN THAT NO DANGEROUS VOLTAGE IS PRESENT.



1. Ensure that the calibration source **OUTPUT** is **OFF** and Local Guard is selected.
2. Connect the 4950 to the calibration source.

Calibrate DC Current at Nominal or Non-Nominal Values

General Sequence

After the initial setup and connecting up, use the following general sequence to calibrate the bands as shown on the table opposite. Do not calibrate a band of $\pm 100\%$ without first having calibrated its corresponding 0% band to the source zero. Just one range can be calibrated if required, but for a full calibration start with the 100 μ A range and work up to the 10A range.

Nominal: To calibrate at Nominal values, **omit** the operations in the shaded boxes .

Non-Nominal: The **Set** feature allows a user to enter the true output value of the calibration standard where it differs from nominal full range or zero. In this case **include** the shaded operations .

4950 Automatic \pm Band Selection

When calibrating DCI 100% bands, there is no facility to select band polarity. The 4950 recognizes the input polarity and automatically selects the appropriate positive or negative version of the selected band.

Calibration Source Zeros

Before calibrating any 4950 range, ensure that for calibration sources with positive and negative outputs, both positive and negative zero outputs have the same value.

Band Calibration Procedure

4950

Press the **DCI** key to obtain the DCI *ranges* menu.

Press the required *range* soft key to obtain that range's *measurement bands* menu.

Press the required *band* soft key to select the *required measurement band*.

Calibration Source

Select required output for the band.

Set Output **ON**. * ‡

4950

Press the **Cal** key to see the CAL menu.

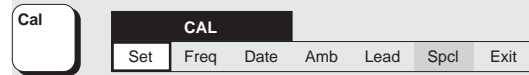

Select **Set** to obtain the SET VALUE menu.

The SET VALUE menu always shows the nominal value for the band. e.g:



Using the **numeric** keys, **key in** the true output value of the standard, then press the **Enter** key.

4950

Press **Caltrig**. Calibration is complete when the **Busy** legend goes out.

Calibration Source

Set Output **OFF**.

Range	Band	Target Value
100µA	0%	0µA
100µA	+100%	+100µA
100µA	-100%	-100µA
1mA	0%	0mA
1mA	+100%	+1mA
1mA	-100%	-1mA
10mA	0%	0mA
10mA	+100%	+10mA
10mA	-100%	-10mA
100mA	0%	0mA
100mA	+100%	+100mA
100mA	-100%	-100mA
1A‡	0%	0A
1A‡	+100%	+1A
1A‡	-100%	-1A
10A*‡	0%	0A
10A*‡	+100%	+10A
10A*‡	-100%	-10A

**DC Current Calibration Procedure -
Recommended Sequence
to Calibrate Ranges and Bands**

* For the 10A range, the designated model 4953 10A shunt is required.

‡ For the 1A and 10A ranges, allow 10 minutes settling time for the shunt to stabilize thermally.

AC Current Calibration - 100 μ A to 10A Ranges

Use of Model 4953 10A Shunt

Rationale

In order to calibrate the 10A range, it is necessary to use a Model 4953 10A shunt.

If traceability is to be maintained, it is essential that same shunt be used when making any subsequent 10A range measurements. For this reason, the serial number of the particular shunt used for calibration is placed into 4950 non-volatile memory, and the ACI 10A range is locked out and cannot be activated unless:

- a. **Shunt#** has been pre-selected in either the ACI CONFIG or DCI CONFIG menu, and then:
- b. the serial number of the shunt used to calibrate the 10A range has been entered in the SHUNT SER # menu.

The recorded serial number of the shunt can be viewed using the STATUS CONFIG menu.

In this section, two procedures are given:

1. Entry of the 4953 10A Shunt serial number.
2. Calibration of ACI 100 μ A to 10A ranges.

N.B. The same shunt is used both for ACI and DCI measurements. Procedure (1) may already have been carried out for DC Current calibration.

Identify the Model 4953 10A Shunt

Press the **ACI** key; select the **100 μ A** range.

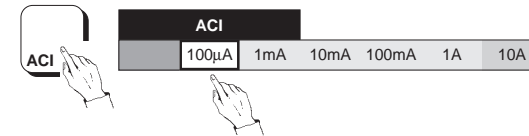

Press the front panel **Cal** key to obtain the CAL menu.

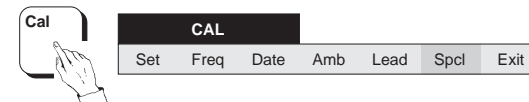

Press the front panel **Config** key to obtain the CAL CONFIG menu.

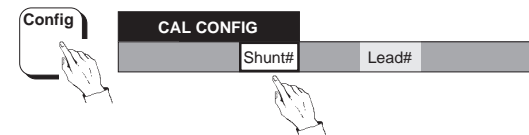

Press the soft **Shunt#** key to obtain the SHUNT SER # menu.



Check that the serial number marked on the 4953 shunt is the same as that shown on the dot-matrix display. If the numbers match, press the **Quit** soft key to return to the CAL CONFIG menu. If the numbers do not match, consult your Calibration Manager, as there may be some administrative problem.

After consultation, if it is required to calibrate the 10A range using a different shunt, write the serial number of the new shunt into the SHUNT SER # menu using the **numeric keyboard**.

Unlock the 10A Range

Press the front panel **ACI** key to obtain the ACI *ranges* menu.

Press the front panel **Config** key to obtain the ACI CONFIG menu.



Press the soft **Shunt#** key for the SHUNT SER # menu.



Use the **numeric keyboard** to write the serial number of the correct 10A shunt into the SHUNT SER # menu.



Press the soft **Enter** key to unlock the 10A range.

Continued overleaf

AC Current Calibration (Contd)

Initial 4950 Setup

1. Press the **ACI** key; select the **100µA** range.

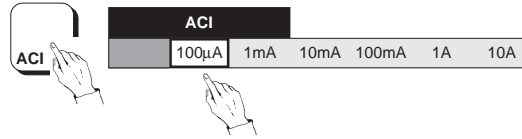

Connect 4950 to Calibration source

WARNING THIS INSTRUMENT CAN DELIVER A LETHAL ELECTRIC SHOCK. NEVER TOUCH ANY LEAD OR TERMINAL UNLESS YOU ARE ABSOLUTELY CERTAIN THAT NO DANGEROUS VOLTAGE IS PRESENT.



1. Ensure that the calibration source **OUTPUT** is **OFF** and Local Guard is selected.
2. Connect the 4950 to the calibration source.

To Calibrate AC Current at Nominal or Non-Nominal Values

After the initial setup and connecting up, calibrate the ranges. Use the sequence of frequency bands shown in the table, repeating the band calibration procedure for each band. Just one range can be calibrated if required; but for a full calibration, start with the 100µA range and work up to the 10A range.

Nominal: To calibrate at Nominal values, **omit** the operations in the shaded boxes .

Non-Nominal: The **Set** feature allows a user to enter the true output value of the calibration standard where it differs from nominal.

In this case **include** the shaded operations .

Band Calibration Procedure

4950

Press the **ACI** key to obtain the ACI *ranges* menu.

Press the required *range* soft key to obtain that range's *frequency bands* menu.

Press the required *frequency* soft key to select the required *frequency band*.

Calibration Source

Select the required frequency and output target value for the band.

Set Output **ON**. * ‡

4950

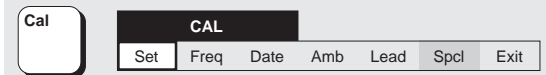

Press the **Cal** key to see the CAL menu. Select **Set** to obtain the SET VALUE menu. The SET VALUE menu always shows the nominal value for the band. e.g:



Using the **numeric** keys, **key in** the true output value of the standard, then press the **Enter** key.

4950

Press **Caltrig**. Calibration is complete when the **Busy** legend goes out.

Calibration Source

Set Output **OFF**.

AC Current Calibration Procedure - Recommended Sequence to Calibrate Ranges and Frequency Bands

Work down the left-hand column in sequence from top to bottom, then move to the next column, and so on. Use Nominal 100% Range values.

Ranges:	100µA	1mA	10mA	100mA	1A ‡	10A * ‡
Frequency	300Hz	300Hz	300Hz	300Hz	300Hz	300Hz
Bands	5kHz	5kHz	5kHz	5kHz	5kHz	10kHz
	10Hz	10Hz	10Hz	10Hz	10Hz	10Hz
	20Hz	20Hz	20Hz	20Hz	20Hz	20Hz
	30Hz	30Hz	30Hz	30Hz	30Hz	30Hz
	40Hz	40Hz	40Hz	40Hz	40Hz	40Hz
	55Hz	55Hz	55Hz	55Hz	55Hz	55Hz
	1kHz	1kHz	1kHz	1kHz	1kHz	1kHz
	10kHz	10kHz	10kHz	10kHz	10kHz	5kHz
	20kHz	20kHz	20kHz	20kHz	20kHz	10kHz
	30kHz	30kHz	30kHz	30kHz	30kHz	20kHz

* For the 10A range, the designated model 4953 10A shunt is required.

‡ For the 1A and 10A ranges, allow 10 minutes settling time for the shunt to stabilize thermally.

This page intentionally left blank

Ohms Calibration

4-Wire & 2-Wire Ohms Calibration

There is no requirement to calibrate the 4950 instrument in 2-wire Ohms mode.

Internally, the Ohms function always operates in 4-wire mode, and the 2-wire Ω mode is effected by shorting I+ to Hi, and I- to Lo at the front panel input plug pins. The only 2-wire connections are therefore the Hi and Lo leads within the input lead.

The instrument is calibrated in 4-wire mode. To allow for corrections in 2-wire operation, the series resistance of the Hi and Lo wires in the designated input lead can be calibrated separately. The characterization of the designated lead is held in 4950 non-volatile memory, and used to apply compensation when measurements are being taken in 2-wire mode; after 2w Ω has been selected in the OHMS CONFIG menu.

If traceability is to be maintained, it is therefore essential for any 2-wire measurements to be made using the characterized lead. For this reason, it is not possible to make 2-wire measurements in Normal mode unless:

- a. **Lead#** has been selected in the OHMS CONFIG menu, and then:
- b. the serial number of the designated input lead has been entered in the LEAD SER # menu.

In this section, two procedures are given:

1. Calibration of all ranges in 4-wire Ohms mode.
2. Characterization of the designated input lead for use with 2-wire Ohms operation, including the entry of the input lead serial number.

Initial 4950 Setup

1. Press the **Ohms** key; ensure that the **100k Ω** range is selected.

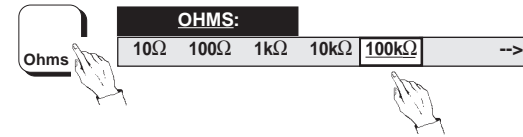

Connect 4950 to Calibration Source

WARNING THIS INSTRUMENT CAN DELIVER A LETHAL ELECTRIC SHOCK. NEVER TOUCH ANY LEAD OR TERMINAL UNLESS YOU ARE ABSOLUTELY CERTAIN THAT NO DANGEROUS VOLTAGE IS PRESENT.



1. Ensure that the calibration source OUTPUT is OFF and Local Guard is selected.
2. Connect the 4950 in 4-wire mode to the calibration source.

Continued Overleaf

To Calibrate 4-wire Ohms at Nominal or Non-Nominal Values

After the initial setup and connecting up in 4-wire mode, use the band calibration procedure to calibrate the bands in the order shown on the table opposite.

The recommended sequence of calibration, at 0% and then at 100%, will generate a gain correction, which is also applied proportionately to the 10%, 30%, and 190% bands (where applicable), assuming perfect linearity. This is sufficient to satisfy the 30 day transfer specification.

After calibrating at 0% and 100%, any user who needs to transfer more accurately at say, 30%, is at liberty to recalibrate to a higher standard at this level. Such a correction will not affect the calibration of any other band, but corrections from subsequent recalibration at 0% and 100% will overwrite all other bands in the range.

Just one range can be calibrated if required, but for a full calibration start with the 100k Ω range, work up to the 100M Ω range and then down from the 10k Ω range to the 10 Ω range.

Nominal: To calibrate at Nominal values, omit the operations in the shaded boxes .

Non-Nominal: The **Set** feature allows a user to enter the true output value of the calibration standard where it differs from nominal..

In this case **include** the shaded operations .

Band Calibration Procedure

4950

Press the **Ohms** key to obtain the OHMS *ranges* menu.

Press the required *range* soft key to obtain that range's *measurement bands* menu.

Press the required *band* soft key to select the *required measurement band*.

Calibration Source

Select required Standard Resistance for the band. Set Output **ON**.

4950

Press the **Cal** key to see the CAL menu.

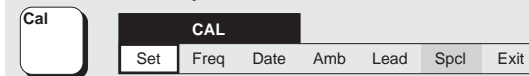

Select **Set** to obtain the SET VALUE menu.

The SET VALUE menu always shows the nominal value for the band. e.g:



Using the **numeric** keys, **key in** the true resistance value of the standard, then press the **Enter** key.

4950

Press **Caltrig**. Calibration is complete when the **Busy** legend goes out.

Calibration Source

Set Output **OFF**.

Two-wire Ohms - Lead Characterization

Rationale:

If it is intended to use the 4950 to transfer traceability in 2-wire Ohms mode, the input cable becomes a link in the chain of artifacts. The series resistance of the cable's Hi and Lo leads *must* therefore be characterized, and the same cable *must* be used with the instrument as part of the MTS system when calibrating a calibrator; if traceability is to be maintained.

The 4950 method of characterizing the lead employs a 4-wire technique to measure its resistance. The proper time to do this is *after* the 4-wire Ohms 10Ω range has been calibrated, so that no change of gain due to the 4-wire calibration will corrupt the stored characterization.

It follows that where the 4950 is used in this role, the input cable *must* be re-characterized for two-wire operation, after every 4-wire Ohms calibration.

The cable which is to be characterized must be recognizable, so that when the instrument is subsequently used to calibrate calibrators, its series Hi-Lo resistance can be automatically subtracted from measurements. In the following procedure, the first operation is to identify the designated input cable. This is done by recording its serial number in the 4950's non-volatile memory, then measuring and recording its series Hi-Lo lead resistance.

Range	Band	Target Value
100kΩ	0%	0kΩ
100kΩ	100%	100kΩ
1MΩ	0%	0MΩ
1MΩ	100%	1MΩ
10MΩ	0%	0MΩ
10MΩ	100%	10MΩ
100MΩ	0%	0MΩ
100MΩ	100%	100MΩ
10kΩ	0%	0kΩ
10kΩ	100%	10kΩ
1kΩ	0%	0kΩ
1kΩ	100%	1kΩ
100Ω	0%	0Ω
100Ω	100%	100Ω
10Ω	0%	0Ω
10Ω	100%	10Ω
Ohms Calibration Procedure - Recommended Sequence to Calibrate Ranges and Bands		

Other Resistance Bands

During the above sequence, the other (10%, 30% and 190%) resistance bands automatically receive internal calibration, by proportionately adjusting their calibration memories to account for linearity. If required, each of these bands can then be independently verified or adjusted against a separate standard, in a similar way to that shown above, without disturbing the calibrations of the 0% and 100% bands.

Continued Overleaf

Two-wire Ohms - Lead Characterization (Contd.)

Characterization Procedure

N.B. This must not be done until the 4-wire Ohms calibration has been completed. It is assumed that the instrument remains in Calibration mode, and that High Accuracy mode is selected.

Record the Input Cable Serial Number:

Press the front panel **Ohms** key to obtain the OHMS menu.

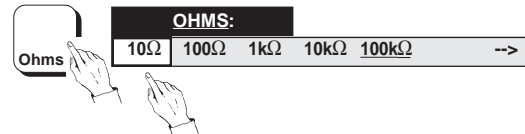

Press the soft **10Ω** key for the 10Ω range menu and select the **0%** band.

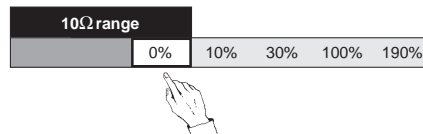

Press the front panel **Cal** key to obtain the CAL menu.

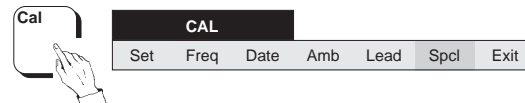

Press the front panel **Config** key to obtain the CAL CONFIG menu and then press the soft **Lead#** key for the LEAD SER # menu.

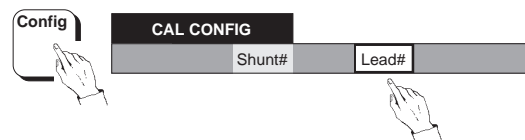

Check the lead serial number marked on the input cable against that shown on the dot-matrix display. If they are different, refer the fact to your Calibration Manager, as there may be an administration problem. Once characterization of the new lead is authorized, its serial number can be entered:

Use the **numeric keyboard** to write the correct lead serial number into the LEAD SER # menu.



Press the soft **Enter** key to record the lead serial number. The dot-matrix display reverts to the CAL CONFIG menu.

Now that the serial numbers match, proceed with lead calibration:

Calibrate the Input Cable for 2-wire Ohms:

Short the Input Hi to Lo:

Turn off the calibration source output and disconnect the 4950 input leads from the source. Plug the (Red) **Hi** lead into the rear of the (Black) **Lo** lead. Connections to the other three leads are irrelevant.

Calibrate the Lead:

Press the front panel **Ohms** key to obtain the OHMS menu. The 10Ω range should still be selected.

Press the front panel **Config** key to obtain the OHMS CONFIG menu.

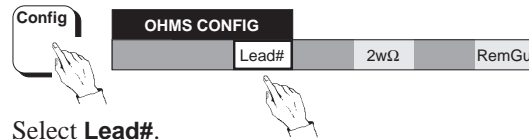

Select **Lead#**.

Use the **numeric keyboard** to write the correct lead serial number into the LEAD SER # menu.



Press the soft **Enter** key to record the lead serial number. The dot-matrix display reverts to the OHMS CONFIG menu.

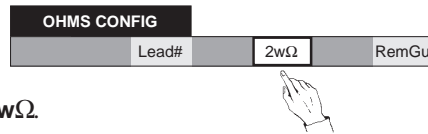

Select **2wΩ**.

Press the front panel **Cal** key to obtain the CAL menu.

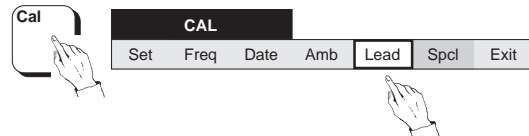

Press the soft **Lead** key to calibrate the lead.

The following message will appear during the calibration period:



The following message will appear when lead calibration is complete:



Check the Lead Characterization

Press the front panel **Status** key.



Press the front panel **Config** key to obtain the STATUS CONFIG menu.

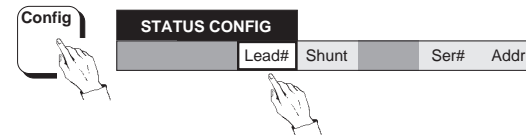

Select **Lead#**.



Check that the serial number is the same as that marked on the lead. Make a note of the lead resistance value for future reference.

Calibration - Conclusion

Exit from Calibration Mode

The following procedure gives the necessary exit and update commands:

1. Ensure that all required calibration has been completed.
Refer to *page 8-3*.
2. Press the front-panel **Cal** key to enter the CAL menu.

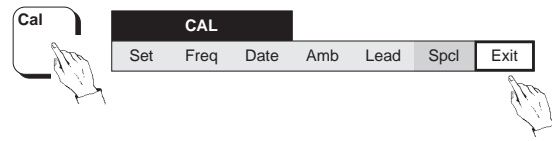

3. In the CAL menu, press the soft **Exit** key for the UPDATE CAL DATE/TEMP ON EXIT? menu.



Carry out either operation (4) or (5) depending on whether it is required to update the date of calibration and the internal ambient temperature before leaving Calibration mode.

4. If update is required, press the **Yes** soft key.
5. If update is **not** required, press the **No** soft key.

Any update is carried out automatically while the following reminder is present on the Dot-matrix display.



The Legend on the Main (Left-hand) Display is extinguished.

The following presentation appears on the dot-matrix display.



6. Set the rear-panel CALIBRATION switch to 'DISABLE'.

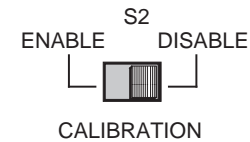

7. Press any front-panel menu key to escape from the Termination presentation.

Wavetek's Regional Sales and Service Offices

CHINA

Wavetek Corporation

Room 2701, Citic Building,
No. 19 Jianguomenwai Dajie,
Beijing 100004,
PRC

Tel: 86 10 6592 8044
Fax: 86 10 6500 8199

UNITED KINGDOM

Wavetek Test & Measurement Division

52 Hurricane Way,
Norwich Airport,
Norwich NR6 6JB,
England

Tel: 44 1603 256 600
Fax: 44 1603 483 670

*Inside rear cover
Final Width = 215mm*

GERMANY

Wavetek GmbH

Gutenbergstrasse 2-4,
85737 Ismaning
Germany

Tel: 49 89 996 41 0
Fax: 49 89 996 41 160

UNITED STATES of AMERICA

Wavetek Corporation Sales & Service

9045 Balboa Avenue,
San Diego,
CA 92123 USA

Tel: 619 279 2200
Fax: 619 450 0325

www.wavetek.com

Rear Cover

Final Width = 215mm